

PRICE SEVENTY FIVE CENTS

# RCA

## Receiving Tube Manual

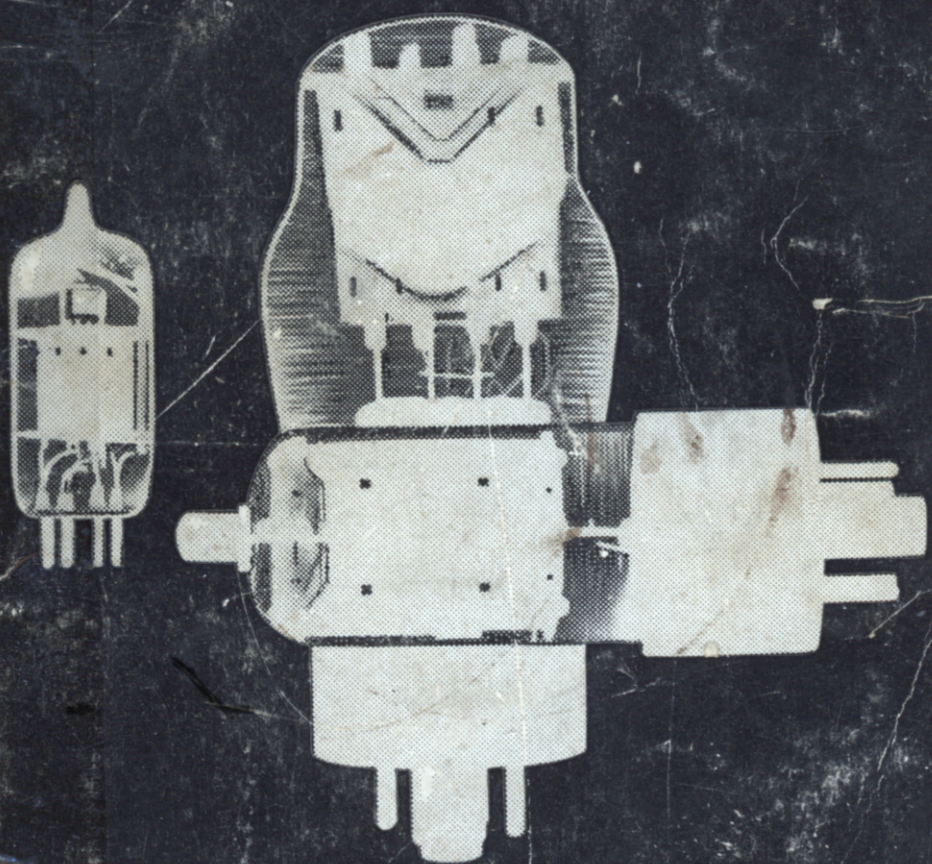

TUBE DIVISION  
RADIO CORPORATION of AMERICA  
HARRISON, N. J.

TECHNICAL SERIES RC-18

# CONTENTS

	PAGE
<b>ELECTRONS, ELECTRODES, AND ELECTRON TUBES</b>	3
Electrons, Cathodes, Generic Tube Types, Diodes, Triodes, Pentodes, Beam Power Tubes, Multi-Electrode and Multi-Unit Types, Television Picture Tubes	
<b>ELECTRON TUBE CHARACTERISTICS</b>	11
<b>ELECTRON TUBE APPLICATIONS</b>	13
Amplification, Rectification, Detection, Automatic Volume or Gain Control, Tuning Indication with Electron-Ray Tubes, Oscillation, Deflection Circuits, Frequency Conversion, Automatic Frequency Control	
<b>ELECTRON TUBE INSTALLATION</b>	53
Filament and Heater Power Supply, Heater-to-Cathode Connection, Plate Voltage Supply, Grid Voltage Supply, Screen-Grid Voltage Supply, Shielding, Dress of Circuit Leads, Filters, Output-Coupling Devices, High-Voltage Considerations for Television Picture Tubes, Picture-Tube Safety Considerations	
<b>INTERPRETATION OF TUBE DATA</b>	63
<b>RECEIVING TUBE CLASSIFICATION CHART</b>	69
<b>TUBE TYPES—Technical Data</b>	73
<b>PICTURE-TUBE CHARACTERISTICS CHART</b>	296
<b>ELECTRON TUBE TESTING</b>	302
<b>RESISTANCE-COUPLED AMPLIFIERS</b>	306
<b>CIRCUITS</b>	319
<b>OUTLINES</b>	339
<b>INDEX</b>	345
<b>READING LIST</b>	352

## Key to Socket Connection Diagrams

### *Bottom Views*

● = Gas-Type Tube	F <sub>M</sub> = Filament Mid-Tap	IS = Internal Shield
BC = Base Sleeve	G = Grid	K = Cathode
BS = Base Shell	H = Heater	NC = No Connection
C = External Conductive Coating	H <sub>L</sub> = Heater Tap for Panel Lamp	P = Plate or Anode
CL = Collector	H <sub>M</sub> = Heater Mid-Tap	RC = Ray-Control Electrode
DJ = Deflecting Electrode	IC = Internal Connection—	S = Shell
ES = External Shield	Do Not Use	TA = Target
F = Filament		

*Alphabetical Subscripts B, D, HP, HX, P, and T indicate, respectively, beam unit, diode unit, heptode unit, hexode unit, pentode unit, and triode unit in multi-unit types.*



Trade Mark Registered  
Marca Registrada

Devices and arrangements shown or described herein may use patents of RCA or others. Information contained herein is furnished without responsibility by RCA for its use and without prejudice to RCA's patent rights.

# RCA Receiving Tube MANUAL

THIS MANUAL like its preceding editions has been prepared to assist those who work or experiment with electron tubes and circuits. It will be found valuable by engineers, service technicians, experimenters, students, radio amateurs, and all others technically interested in electron tubes.

The material in this edition has been augmented and revised to keep abreast of the technological advances in electronic fields. Many tube types widely used in the design of new electronic equipment prior to 1950 are now chiefly of renewal interest; in their place, new advanced types are being used. Consequently, in the Tube Types Section, the presentation on the older types has been limited to essential basic data while detailed information has been given on the newer more important types.

---

In addition to the tube types for home-entertainment use covered in this Manual, the TUBE DIVISION of RADIO CORPORATION OF AMERICA offers other small receiving-type tubes for industrial and specialized applications, such as the "Special Red" tubes, premium tubes, computer tubes, voltage regulators, acorn tubes, and pencil tubes. Other lines of RCA electron devices include:

## **POWER TUBES**

*Transmitting and  
Industrial Types*

## **TELEVISION CAMERA TUBES**

*Iconoscopes, Monoscopes,  
Vidicons, and Image Orthicons*

## **PHOTOTUBES**

*Single-Unit, Twin-Unit,  
and Multiplier Types*

## **THYRATRONS & IGNITRONS**

## **CATHODE-RAY TUBES**

*Special-Purpose  
Kinescopes, Storage Tubes,  
and Oscillograph Tubes*

## **SPECIAL TYPES**

*Vacuum-Gauge Tubes,  
Magnetrons, Traveling-Wave  
Tubes, and Klystrons*

## **SEMICONDUCTOR DEVICES**

*Transistors and Diodes*

---

For Sales Information,  
write to *Sales*

For Technical Information,  
write to *Commercial Engineering*

TUBE DIVISION  
RADIO CORPORATION OF AMERICA  
Harrison, N. J.

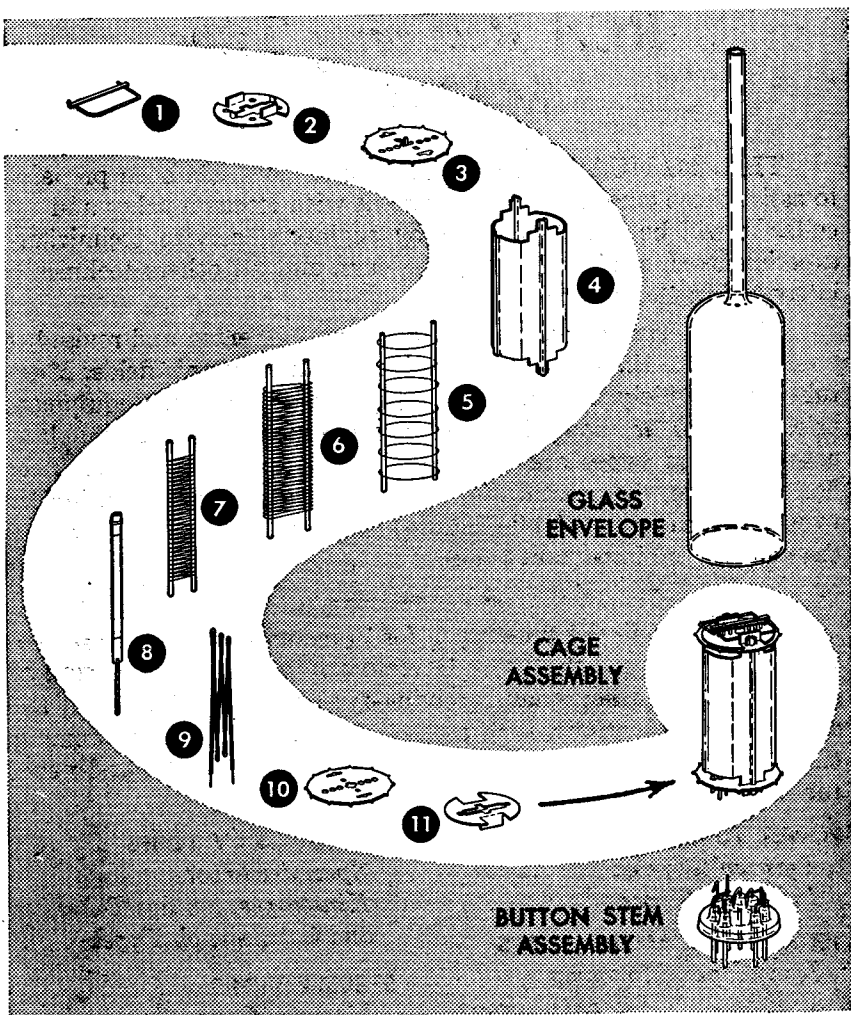

### CAGE PARTS

- |                       |                                    |                          |
|-----------------------|------------------------------------|--------------------------|
| 1. Getter and Support | 5. Grid No. 3<br>(Suppressor Grid) | 8. Cathode               |
| 2. Top Spacer Shield  | 6. Grid No. 2<br>(Screen Grid)     | 9. Heater                |
| 3. Insulating Spacer  | 7. Grid No. 1<br>(Control Grid)    | 10. Insulating Spacer    |
| 4. Plate              |                                    | 11. Bottom Spacer Shield |

## The Parts of a Miniature Pentode

# RCA Receiving Tube MANUAL

## Electrons, Electrodes, and Electron Tubes

The electron tube is a marvelous device. It makes possible the performing of operations, amazing in conception, with a precision and a certainty that are astounding. It is an exceedingly sensitive and accurate instrument—the product of coordinated efforts of engineers and craftsmen. Its construction requires materials from every corner of the earth. Its use is world-wide. Its future possibilities, even in the light of present-day accomplishments, are but dimly foreseen; for each development opens new fields of design and application.

The importance of the electron tube lies in its ability to control almost instantly the flight of the millions of electrons supplied by the cathode. It accomplishes this control with a minimum of energy. Because it is almost instantaneous in its action, the electron tube can operate efficiently and accurately at electrical frequencies much higher than those attainable with rotating machines.

### Electrons

All matter exists in the solid, liquid, or gaseous state. These three forms consist entirely of minute divisions known as molecules, which, in turn, are composed of atoms. Atoms have a nucleus which is a positive charge of electricity, around which revolve tiny charges of negative electricity known as **electrons**. Scientists have estimated that electrons weigh only 1/30-billion, billion, billion, billionths of an ounce, and that they may travel at speeds of thousands of miles per second.

Electron movement may be accelerated by the addition of energy. Heat is one form of energy which can be conveniently used to speed up the electron. For example, if the temperature of a metal is gradually raised, the electrons

in the metal gain velocity. When the metal becomes hot enough, some electrons may acquire sufficient speed to break away from the surface of the metal. This action, which is accelerated when the metal is heated in a vacuum, is utilized in most electron tubes to produce the necessary electron supply.

An electron tube consists of a cathode, which supplies electrons, and one or more additional electrodes, which control and collect these electrons, mounted in an evacuated envelope. The envelope may be made of glass, metal, ceramic, or a combination of these materials.

### Cathodes

A cathode is an essential part of an electron tube because it supplies the electrons necessary for tube operation. When energy in some form is applied to the cathode, electrons are released. Heat is the form of energy generally used. The method of heating the cathode may be used to distinguish between the different forms of cathodes. For example, a directly heated cathode, or filament-cathode, is a wire heated by the passage of an electric current. An indirectly heated cathode, or heater-cathode, consists of a filament, or heater, enclosed in a metal sleeve. The sleeve carries the electron-emitting material on its outside surface and is heated by radiation and conduction from the heater.

A filament, or directly heated cathode, such as that shown in Fig. 1 may be further classified by identifying the filament or electron-emitting material. The materials in regular use are tungsten, thoriated tungsten, and metals which have been coated with alkaline-earth oxides. Tungsten filaments are made from the pure metal. Because they must operate at high temperatures (a

dazzling white) to emit sufficient electrons, a relatively large amount of filament power is required.

Thoriated-tungsten filaments are made from tungsten impregnated with thorium oxide. Due to the presence of thorium, these filaments liberate electrons at a more moderate temperature of about 1700°C (a bright yellow) and are, therefore, much more economical of filament power than are pure tungsten filaments.

Alkaline earths are usually applied as a coating on a nickel-alloy wire or ribbon. This coating, which is dried in a relatively thick layer on the filament, requires only a relatively low temperature of about 700-750°C (a dull red) to produce a copious supply of electrons. Coated filaments operate very efficiently and require relatively little filament power. However, each of these cathode materials has special advantages which determine the choice for a particular application.

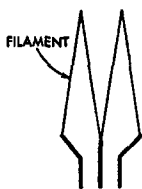

Fig. 1

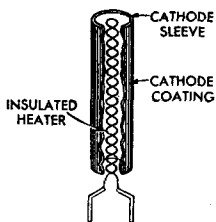

Fig. 2

Directly heated filament-cathodes require comparatively little heating power. They are used in almost all of the tube types designed for battery operation because it is, of course, desirable to impose as small a drain as possible on the batteries. Examples of battery-operated filament types are the 1A7-GT, 1R5, 1U4, and 3V4. AC-operated types having directly heated filament-cathodes include the 2A3 and 5Y3-GT.

An indirectly heated cathode, or heater-cathode, consists of a thin metal sleeve coated with electron-emitting material such as alkaline-earth oxides. Within the sleeve is a heater which is insulated from the sleeve, as shown in Fig. 2. The heater is made of tungsten or tungsten-alloy wire and is used only for the purpose of heating the cathode sleeve

and sleeve coating to an electron-emitting temperature. Useful emission does not take place from the heater wire.

The heater-cathode construction is well adapted for use in electron tubes intended for operation from ac power lines and from storage batteries. The use of separate parts for emitter and heater functions, the electrical insulation of the heater from the emitter, and the shielding effect of the sleeve may all be utilized in the design of the tube to minimize the introduction of hum from the ac heater supply and to minimize electrical interference which might enter the tube circuit through the heater-supply line. From the viewpoint of circuit design, the heater-cathode construction offers advantages in connection flexibility because of the electrical separation of the heater from the cathode.

Another advantage of the heater-cathode construction is that it makes practical the design of a rectifier tube having close spacing between its cathode and plate, and of an amplifier tube having close spacing between its cathode and grid. In a close-spaced rectifier tube, the voltage drop in the tube is low, and, therefore, the regulation is improved. In an amplifier tube, the close spacing increases the gain obtainable from the tube. Because of the advantages of the heater-cathode construction, almost all present-day receiving tubes designed for ac operation have heater-cathodes.

### Generic Tube Types

Electrons are of no value in an electron tube unless they can be put to work. Therefore, a tube is designed with the parts necessary to utilize electrons as well as those required to produce them. These parts consist of a cathode and one or more supplementary electrodes. The electrodes are enclosed in an evacuated envelope having the necessary connections brought out through air-tight seals. The air is removed from the envelope to allow free movement of the electrons and to prevent injury to the emitting surface of the cathode.

When the cathode is heated, electrons leave the cathode surface and form an invisible cloud in the space around it. Any positive electric potential within the evacuated envelope offers a strong

attraction to the electrons (unlike electric charges attract; like charges repel). Such a positive electric potential can be supplied by an **anode** (positive electrode) located within the tube in proximity to the cathode.

### Diodes

The simplest form of electron tube contains two electrodes, a cathode and an anode (plate), and is often called a diode, the family name for a two-electrode tube. In a diode, the positive potential is supplied by a suitable electrical source connected between the plate terminal and a cathode terminal, as shown in Fig. 3. Under the influence of the positive plate potential, electrons flow from the cathode to the plate and return through the external plate-battery circuit to the cathode, thus completing the circuit. This flow of electrons is known as the **plate current**.

If a negative potential is applied to the plate, the free electrons in the space surrounding the cathode will be forced back to the cathode and no plate current will flow. If an alternating voltage is applied to the plate, the plate is alternately made positive and negative. Because plate current flows only during the time when the plate is positive, current flows through the tube in only one direction and is said to be **rectified**. Fig. 4 shows the rectified output current produced by an alternating input voltage.

Diode rectifiers are used in ac receivers to convert the ac supply voltage to dc voltage for the electrodes of the other tubes in the receiver. Rectifier tubes having only one plate and one

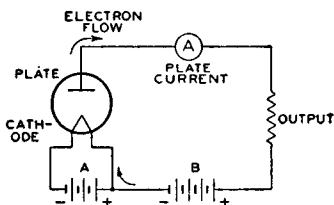

Fig. 3

cathode, such as the 35W4, are called **half-wave rectifiers**, because current can flow only during one-half of the alternating-current cycle. When two plates and one or more cathodes are

used in the same tube, current may be obtained on both halves of the ac cycle. The 6X4, 5Y3-GT, and 5U4-GB are examples of this type and are called **full-wave rectifiers**.

Not all of the electrons emitted by the cathode reach the plate. Some return

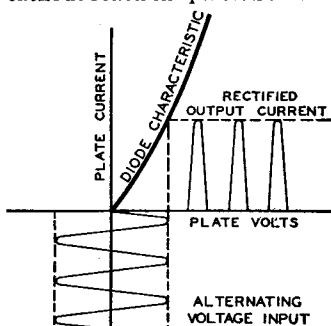

Fig. 4

to the cathode while others remain in the space between the cathode and plate for a brief period to produce an effect known as **space-charge**. This charge has a repelling action on other electrons which leave the cathode surface and impedes their passage to the plate. The extent of this action and the amount of space-charge depend on the cathode temperature, the distance between the cathode and the plate, and the plate potential. The higher the plate potential, the less is the tendency for electrons to remain in the space-charge region and repel other electrons. This effect may be noted by applying increasingly higher plate voltages to a tube operating at a fixed heater or filament voltage. Under these conditions, the maximum number of available electrons is fixed, but increasingly higher plate voltages will succeed in attracting a greater proportion of the free electrons.

Beyond a certain plate voltage, however, additional plate voltage has little effect in increasing the plate current because all of the electrons emitted by the cathode are already being drawn to the plate. This maximum current, illustrated in Fig. 5, is called **saturation current**. Because it is an indication of the total number of electrons emitted, it is also known as **emission current** or simply **emission**.

Although tubes are sometimes tested

by measurement of their emission current, it is generally not advisable to measure the full value of emission because this value would be sufficiently large to cause change in the tube's characteristics or even to damage the tube. Consequently, while the test value of emission current is somewhat larger than

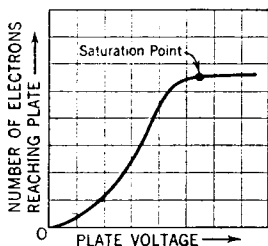

Fig. 5

the maximum current which will be required from the cathode in the use of the tube, it is ordinarily less than the full emission current. The emission test, therefore, is used to indicate whether the cathode can supply a sufficient number of electrons for satisfactory operation of the tube.

If space charge were not present to repel electrons coming from the cathode, the same plate current could be produced at a lower plate voltage. One way to make the effect of space charge small is to make the distance between plate and cathode small. This method is used in rectifier types having heater-cathodes, such as the 5V4-G and the 6AX5-GT. In these types the radial distance between cathode and plate is only about two hundredths of an inch.

Another method of reducing space-charge effect is utilized in **mercury-vapor rectifier tubes**. When such tubes are operated, a small amount of mercury contained in the tube is partially vaporized, filling the space inside the bulb with mercury atoms. These atoms are bombarded by electrons on their way to the plate. If the electrons are moving at a sufficiently high speed, the collisions tear off electrons from the mercury atoms. The mercury atom is then said to be "ionized," *i.e.*, it has lost one or more electrons and, therefore, has a positive charge. Ionization is evidenced

by a bluish-green glow between the cathode and plate. When ionization occurs, the space charge is neutralized by the positive mercury atoms so that increased numbers of electrons are made available. Mercury-vapor tubes are used primarily for power rectifiers.

**Ionic-heated-cathode rectifier tubes**, such as the 0Z4 and 0Z4-G, also depend on gas ionization for their operation. These tubes are of the full-wave design and contain two anodes and a coated cathode sealed in a bulb containing a reduced pressure of inert gas. The cathode in each of these types becomes hot during tube operation, but the heating effect is caused by bombardment of the cathode by ions within the tube rather than by heater or filament current from an external source.

The internal structure of an ionic-heated-cathode tube is designed so that when sufficient voltage is applied to the tube, ionization of the gas occurs between the anode which is instantaneously positive and the cathode. Under normal operating voltages, ionization does not take place between the anode that is negative and the cathode so that the requirements for rectification are satisfied. The initial small flow of current through the tube is sufficient to raise the cathode temperature quickly to incandescence whereupon the cathode emits electrons. The voltage drop in such tubes is slightly higher than that of the usual hot-cathode gas rectifiers because energy is taken from the ionization discharge to keep the cathode at operating temperature. Proper operation of these rectifiers requires a minimum flow of load current at all times in order to maintain the cathode at the temperature required to supply sufficient emission.

### Triodes

When a third electrode, called the **grid**, is placed between the cathode and plate, the tube is known as a triode, the family name for a three-electrode tube. The grid usually consists of relatively fine wire wound on two support rods and extending the length of the cathode. The spaces between turns are comparatively large so that the passage of electrons from cathode to plate is practically unobstructed by the grid wires. The pur-



pose of the grid is to control the flow of plate current. When a tube is used as an amplifier, a negative dc voltage is usually applied to the grid. Under this condition the grid does not draw appreciable current.

The number of electrons attracted to the plate depends on the combined effect of the grid and plate polarities, as shown in Fig. 6. When the plate is positive, as is normal, and the dc grid voltage is made more and more negative, the plate is less able to attract electrons to it and plate current decreases. When the grid is made less and less negative (more and more positive), the plate more readily attracts electrons to it and plate current increases. Hence, when the voltage on the grid is varied in accordance with a signal, the plate current varies with the signal. Because a small voltage applied to the grid can control a comparatively large amount of plate current, the signal is amplified by the tube. Typical three-electrode tube types are the 6C4 and 6AF4-A.

The grid, plate, and cathode of a triode form an electrostatic system, each electrode acting as one plate of a small capacitor. The capacitances are those existing between grid and plate, plate and cathode, and grid and cathode.

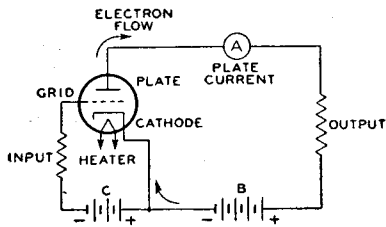

Fig. 6

These capacitances are known as **inter-electrode capacitances**. Generally, the capacitance between grid and plate is of the most importance. In high-gain radio-frequency amplifier circuits, this capacitance may act to produce undesired coupling between the **input circuit**, the circuit between grid and cathode, and the **output circuit**, the circuit between plate and cathode. This coupling is undesirable in an amplifier because it may cause instability and unsatisfactory performance.

## Tetrodes

The capacitance between grid and plate can be made small by mounting an additional electrode, called the **screen grid** (grid No. 2), in the tube. With the addition of the grid No. 2, the tube has four electrodes and is, accordingly, called a tetrode. The screen grid or grid No. 2 is mounted between the grid No. 1 (**control grid**) and the plate, as shown in Fig. 7, and acts as an electrostatic shield between them, thus reducing the grid-to-plate capacitance. The effectiveness of

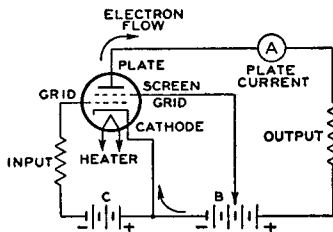

Fig. 7

this shielding action is increased by a bypass capacitor connected between screen grid and cathode. By means of the screen grid and this bypass capacitor, the grid-plate capacitance of a tetrode is made very small. In practice, the grid-plate capacitance is reduced from several micromicrofarads ( $\mu\mu\text{f}$ ) for a triode to  $0.01 \mu\mu\text{f}$  or less for a screen-grid tube.

The screen grid has another desirable effect in that it makes plate current practically independent of plate voltage over a certain range. The screen grid is operated at a positive voltage and, therefore, attracts electrons from the cathode. However, because of the comparatively large space between wires of the screen grid, most of the electrons drawn to the screen grid pass through it to the plate. Hence the screen grid supplies an electrostatic force pulling electrons from the cathode to the plate. At the same time the screen grid shields the electrons between cathode and screen grid from the plate so that the plate exerts very little electrostatic force on electrons near the cathode.

So long as the plate voltage is higher than the screen-grid voltage, plate current in a screen-grid tube depends to a great degree on the screen-grid voltage and very little on the plate voltage. The fact that plate current in a screen-grid

tube is largely independent of plate voltage makes it possible to obtain much higher amplification with a tetrode than with a triode. The low grid-plate capacitance makes it possible to obtain this high amplification without plate-to-grid feedback and resultant instability. In receiving-tube applications, the tetrode has been replaced to a considerable degree by the pentode.

### Pentodes

In all electron tubes, electrons striking the plate may, if moving at sufficient speed, dislodge other electrons. In two- and three-electrode types, these dislodged electrons usually do not cause trouble because no positive electrode other than the plate itself is present to attract them. These electrons, therefore, are drawn back to the plate. Emission caused by bombardment of an electrode by electrons from the cathode is called **secondary emission** because the effect is secondary to the original cathode emission.

In the case of screen-grid tubes, the proximity of the positive screen grid to the plate offers a strong attraction to these secondary electrons and particularly so if the plate voltage swings lower than the screen-grid voltage. This effect lowers the plate current and limits the useful plate-voltage swing for tetrodes.

The effects of secondary emission are minimized when a fifth electrode is placed within the tube between the screen grid and plate. This fifth electrode is known as the **suppressor grid** (grid No.3) and is usually connected to the cathode, as shown in Fig. 8. Because of

The family name for a five-electrode tube is "pentode". In power-output pentodes, the suppressor grid makes possible higher power output with lower grid-driving voltage; in radio-frequency amplifier pentodes the suppressor grid makes possible high voltage amplification at moderate values of plate voltage. These desirable features result from the fact that the plate-voltage swing can be made very large. In fact, the plate voltage may be as low as, or lower than, the screen-grid voltage without serious loss in signal-gain capability. Representative pentodes used for power amplification are the 3V4 and 6K6-GT; representative pentodes used for voltage amplification are the 1U4, 6AU6, 12SK7, and 6BA6.

### Beam Power Tubes

A beam power tube is a tetrode or pentode in which directed electron beams are used to increase substantially the power-handling capability of the tube. Such a tube contains a cathode, a control grid (grid No.1), a screen grid (grid No.2), a plate, and, optionally, a suppressor grid (grid No.3). When a beam power tube is designed without an actual suppressor grid, the electrodes are so spaced that secondary emission from the plate is suppressed by space-charge effects between screen grid and plate. The space charge is produced by the slowing up of electrons traveling from a high-potential screen grid to a lower-potential plate. In this low-velocity region, the space charge produced is sufficient to repel secondary electrons emitted from the plate and to cause them to return to the plate.

Beam power tubes of this design employ beam-confining electrodes at cathode potential to assist in producing the desired beam effects and to prevent stray electrons from the plate from returning to the screen grid outside of the beam. A feature of a beam power tube is its low screen-grid current. The screen grid and the control grid are spiral wires wound so that each turn of the screen grid is shaded from the cathode by a grid turn. This alignment of the screen grid and control grid causes the electrons to travel in sheets between the turns of the screen grid so that very few of them strike the screen grid. Because of the

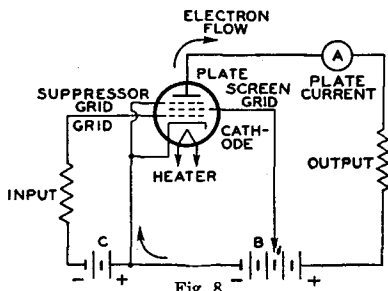

its negative potential with respect to the plate, the suppressor grid retards the flight of secondary electrons and diverts them back to the plate.

effective suppressor action provided by space charge and because of the low current drawn by the screen grid, the beam power tube has the advantages of high power output, high power sensitivity, and high efficiency.

Fig. 9 shows the structure of a beam power tube employing space-charge suppression and illustrates how the electrons

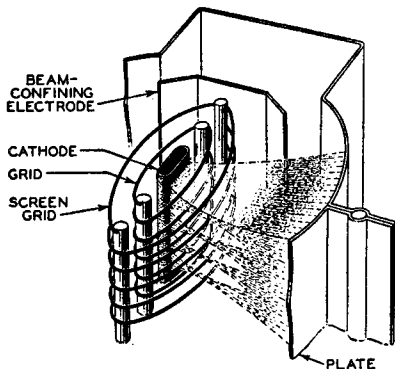

Fig. 9

are confined to beams. The beam condition illustrated is that for a plate potential less than the screen-grid potential. The high-density space-charge region is indicated by the heavily dashed lines in the beam. Note that the edges of the beam-confining electrodes coincide with the dashed portion of the beam. In this way the space-charge potential region is extended beyond the beam boundaries and stray secondary electrons are prevented from returning to the screen grid outside of the beam. The space-charge effect may also be obtained by use of an actual suppressor grid. Examples of beam power tubes are 6AQ5, 6L6-G, 6V6-GT, and 50C5.

### Multi-Electrode and Multi-Unit Tubes

Early in the history of tube development and application, tubes were designed for general service; that is, a single tube type—a triode—was used as a radio-frequency amplifier, an intermediate-frequency amplifier, an audio-frequency amplifier, an oscillator, or a detector. Obviously, with this diversity of application, one tube did not meet all requirements to the best advantage.

Later and present trends of tube design are the development of "specialty" types. These types are intended either to give optimum performance in a particular application or to combine in one bulb functions which formerly required two or more tubes. The first class of tubes includes such examples of specialty types as the 6CB6 and 6BY6. Types of this class generally require more than three electrodes to obtain the desired special characteristics and may be broadly classed as multi-electrode types. The 6BY6 is an especially interesting type in this class. This tube has an unusually large number of electrodes, namely seven, exclusive of the heater. Plate current in the tube is varied at two different frequencies at the same time. The tube is designed primarily for use as a combined sync separator and sync clipper in television receivers.

The second class includes multi-unit tubes such as the twin-diode triodes 6BF6 and 6AV6, as well as triode-pentodes such as the 6U8 and 6X8. This class also includes class A twin triodes such as the 6CG7 and 12AX7, and types such as the 6CM7 containing dissimilar triode units used primarily as combined vertical oscillators and vertical deflection amplifiers in television receivers. Full-wave rectifiers are also multi-unit types.

A third class of tubes combines features of each of the other two classes. Typical of this third class are the pentagrid-converter types 1R5, 6BE6, and 6SA7. These tubes are similar to the multi-electrode types in that they have seven electrodes, all of which affect the electron stream; and they are similar to the multi-unit tubes in that they perform simultaneously the double function of oscillator and mixer in superheterodyne receivers.

### Television Picture Tubes

The picture tube, or kinescope, is a multi-electrode tube used principally in television receivers for picture display. It consists essentially of an electron gun, a glass or metal-and-glass envelope and face-plate combination, and a fluorescent screen.

The electron gun includes a cathode for the production of free electrons, one

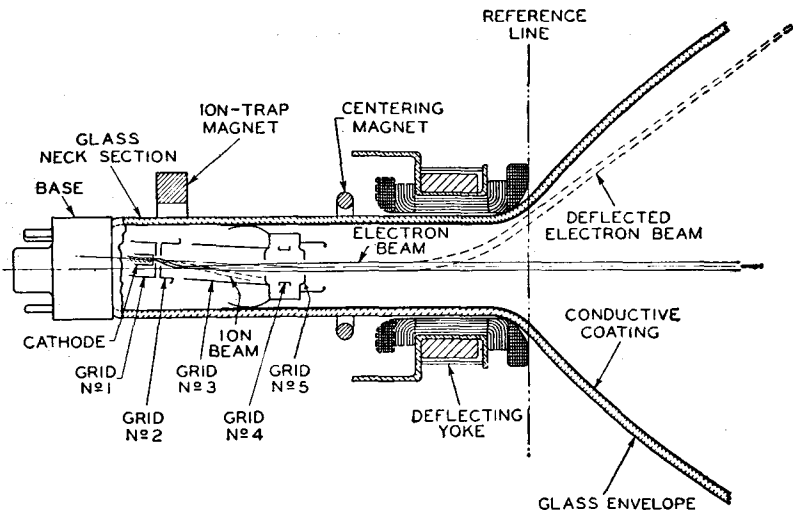

Fig. 10

or more control electrodes for accelerating the electrons in the beam, and, optionally, a device for "trapping" unwanted ions out of the electron beam.

Focusing of the beam is accomplished either electromagnetically by means of a focusing coil placed on the neck of the tube, or electrostatically, as shown in Fig. 10, by means of focusing electrodes (grids No. 4 and No. 5) within the envelope of the tube. The screen is a white-fluorescing phosphor P4 of either the silicate or the sulfide type.

Deflection of the beam is accomplished either electrostatically by means of deflecting electrodes within the envelope of the tube, or electromagnetically

by means of a deflecting yoke placed on the neck of the tube. Fig. 10 shows the structure of the gun section of a picture tube and illustrates how the electron beam is formed, how the ions are separated from the electron beam by means of the tilted-gun and ion-trap-magnet arrangement, and how the beam is deflected by means of an electromagnetic deflecting yoke.

The color kinescope 21AXP22-A consists of three electron guns and an aluminized, tricolor, phosphor-dot screen on the inner surface of the spherical filter-glass faceplate. It utilizes magnetic convergence, electrostatic focus, and magnetic deflection.

# Electron Tube Characteristics

The term "characteristics" is used to identify the distinguishing electrical features and values of an electron tube. These values may be shown in curve form or they may be tabulated. When the characteristics values are given in curve form, the curves may be used for the determination of tube performance and the calculation of additional tube factors.

Tube characteristics are obtained from electrical measurements of a tube in various circuits under certain definite conditions of voltages. Characteristics may be further described by denoting the conditions of measurements. For example Static Characteristics are the values obtained with different dc potentials applied to the tube electrodes, while Dynamic Characteristics are the values obtained with an ac voltage on a control grid under various conditions of dc potentials on the electrodes. The dynamic characteristics, therefore, are indicative of the performance capabilities of a tube under actual working conditions.

**Static characteristics** may be shown by plate characteristic curves and transfer (mutual) characteristic curves. These curves present the same information, but in two different forms to increase its usefulness. The plate characteristic curve is obtained by varying plate voltage and measuring plate current for different grid bias voltages, while the transfer-characteristic curve is obtained by varying grid bias voltage and measuring plate current for different plate voltages. A plate-characteristic family of curves is illustrated by Fig. 11. Fig. 12 gives the transfer-characteristic family of curves for the same tube.

**Dynamic characteristics** include amplification factor, plate resistance, control-grid—plate transconductance, and certain detector characteristics, and may be shown in curve form for variations in tube operating conditions.

The **amplification factor**, or  $\mu$ , is the ratio of the change in plate voltage to a change in control-electrode voltage in the opposite direction, under the condition that the plate current remains unchanged and that all other electrode

voltages are maintained constant. For example, if, when the plate voltage is made 1 volt more positive, the control-electrode (grid-No.1) voltage must be made 0.1 volt more negative to hold plate current unchanged, the amplification factor is 1 divided by 0.1, or 10. In other words, a small voltage variation in the grid circuit of a tube has the same effect on the plate current as a large

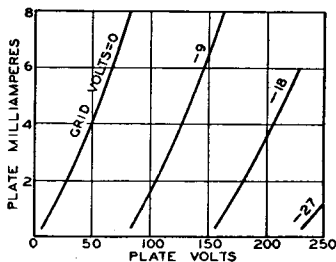

Fig. 11

plate-voltage change—the latter equal to the product of the grid-voltage change and amplification factor. The  $\mu$  of a tube is often useful for calculating stage gain. This use is discussed in the ELECTRON TUBE APPLICATIONS SECTION.

**Plate resistance** ( $r_p$ ) of an electron tube is the resistance of the path between

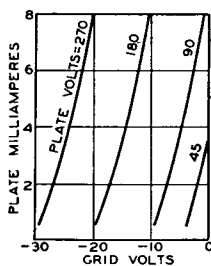

Fig. 12

cathode and plate to the flow of alternating current. It is the quotient of a small change in plate voltage divided by the corresponding change in plate current and is expressed in ohms, the unit of resistance. Thus, if a change of 0.1 milliampere (0.0001 ampere) is produced by a plate voltage variation of 1 volt, the plate resistance is 1 divided by 0.0001, or 10000 ohms.

**Control-grid—plate transconductance**, or simply **transconductance** ( $g_m$ ), is a factor which combines in one term the amplification factor and the plate resistance, and is the quotient of the first divided by the second. This term has also been known as mutual conductance. Transconductance may be more strictly defined as the quotient of a small change in plate current (amperes) divided by the small change in the control-grid voltage producing it, under the condition that all other voltages remain unchanged. Thus, if a grid-voltage change of 0.5 volt causes a plate-current change of 1 milliamperes (0.001 ampere), with all other voltages constant, the transconductance is 0.001 divided by 0.5, or 0.002 mho. A "mho" is the unit of conductance and was named by spelling ohm backwards. For convenience, a millionth of a mho, or a micromho ( $\mu$ mho), is used to express transconductance. Thus, in the example, 0.002 mho is 2000 micromhos.

**Conversion transconductance** ( $g_c$ ) is a characteristic associated with the mixer (first detector) function of tubes

and may be defined as the quotient of the intermediate-frequency (if) current in the primary of the if transformer divided by the applied radio-frequency (rf) voltage producing it; or more precisely, it is the limiting value of this quotient as the rf voltage and if current approach zero. When the performance of a frequency converter is determined, conversion transconductance is used in the same way as control-grid—plate transconductance is used in single-frequency amplifier computations.

The **plate efficiency** of a power amplifier tube is the ratio of the ac power output ( $P_o$ ) to the product of the average dc plate voltage ( $E_b$ ) and dc plate current ( $I_b$ ) at full signal, or

$$\text{Plate efficiency (\%)} = \frac{P_o \text{ watts}}{E_b \text{ volts} \times I_b \text{ amperes}} \times 100$$

The **power sensitivity** of a tube is the ratio of the power output to the square of the input signal voltage ( $E_{in}$ ) and is expressed in mhos as follows:

$$\text{Power sensitivity (mhos)} = \frac{P_o \text{ watts}}{(E_{in, rms})^2}$$

# Electron Tube Applications

The diversified applications of an electron receiving tube have, within the scope of this section, been treated under seven headings. These are: Amplification, Rectification, Detection, Automatic Volume or Gain Control, Oscillation, Frequency Conversion, and Automatic Frequency Control. Although these operations may take place at either radio or audio frequencies and may involve the use of different circuits and different supplemental parts, the general considerations of each kind of operation are basic.

## Amplification

The amplifying action of an electron tube was mentioned under **Triodes** in the section on **ELECTRONS, ELECTRODES, and ELECTRON TUBES**. This action can be utilized in electronic circuits in a number of ways, depending upon the results desired. Four classes of amplifier service recognized by engineers are covered by definitions standardized by the Institute of Radio Engineers. This classification depends primarily on the fraction of input cycle during which plate current is expected to flow under rated full-load conditions. The classes are class A, class AB, class B, and class C. The term "cutoff bias" used in these definitions is the value of grid bias at which plate current is some very small value.

### Classes of Service

A **class A amplifier** is an amplifier in which the grid bias and alternating grid voltages are such that plate current in a specific tube flows at all times.

A **class AB amplifier** is an amplifier in which the grid bias and alternating grid voltages are such that plate current in a specific tube flows for appreciably more than half but less than the entire electrical cycle.

A **class B amplifier** is an amplifier in which the grid bias is approximately equal to the cutoff value, so that the plate current is approximately zero when no exciting grid voltage is applied, and so that plate current in a specific

tube flows for approximately one-half of each cycle when an alternating grid voltage is applied.

A **class C amplifier** is an amplifier in which the grid bias is appreciably greater than the cutoff value, so that the plate current in each tube is zero when no alternating grid voltage is applied, and so that plate current flows in a specific tube for appreciably less than one-half of each cycle when an alternating grid voltage is applied.

The suffix 1 may be added to the letter or letters of the class identification to denote that grid current does not flow during any part of the input cycle. The suffix 2 may be used to denote that grid current flows during some part of the cycle.

For radio-frequency (rf) amplifiers which operate into a selective tuned circuit, as in radio transmitter applications, or under requirements where distortion is not an important factor, any of the above classes of amplifiers may be used, either with a single tube or a push-pull stage. For audio-frequency (af) amplifiers in which distortion is an important factor, only class A amplifiers permit single-tube operation. In this case, operating conditions are usually chosen so that distortion is kept below the conventional 5 per cent for triodes and the conventional 7 to 10 per cent for tetrodes or pentodes. Distortion can be reduced below these figures by means of special circuit arrangements such as that discussed under **inverse feedback**. With class A amplifiers, reduced distortion with improved power performance can be obtained by using a push-pull stage for audio service. With class AB and class B amplifiers, a balanced amplifier stage using two tubes is required for audio service.

### Class A Voltage Amplifiers

As a class A voltage amplifier, an electron tube is used to reproduce grid-voltage variations across an impedance or a resistance in the plate circuit. These variations are essentially of the same form as the input signal voltage impressed on the grid, but their amplitude

is increased. This increase is accomplished by operation of the tube at a suitable grid bias so that the applied grid input voltage produces plate-current variations proportional to the signal swings. Because the voltage variation obtained in the plate circuit is much larger than that required to swing the grid, amplification of the signal is obtained.

Fig. 13 gives a graphical illustration of this method of amplification and

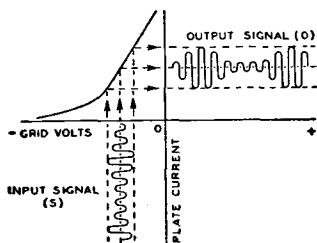

Fig. 13

shows, by means of the grid-voltage vs. plate-current characteristics curve, the effect of an input signal (S) applied to the grid of a tube. The output signal (O) is the resulting amplified plate-current variation.

The plate current flowing through the load resistance (R) of Fig. 14 causes a voltage drop which varies directly with the plate current. The ratio of this voltage variation produced in the load

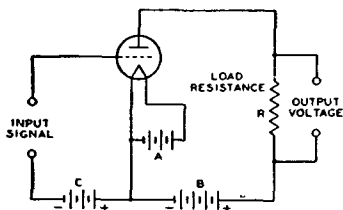

Fig. 14

resistance to the input signal voltage is the voltage amplification, or **gain**, provided by the tube. The voltage amplification due to the tube is expressed by the following convenient formulas:

$$\text{Voltage amplification} = \frac{\mu \times R_L}{R_L + r_p}$$

$$\text{or } \frac{g_m \times r_p \times R_L}{1000000 \times (r_p + R_L)}$$

where  $\mu$  is the amplification factor of the tube,  $R_L$  is the load resistance in

ohms,  $r_p$  is the plate resistance in ohms, and  $g_m$  is the transconductance in micromhos.

From the first formula, it can be seen that the gain actually obtainable from the tube is less than the tube's amplification factor but that the gain approaches the amplification factor when the load resistance is large compared to the tube's plate resistance. Fig. 15 shows graphically how the gain approaches the amplification factor of the tube as the load resistance is increased. From the curve it can be seen that a high value of load resistance should be used to obtain high gain in a voltage amplifier.

In a resistance-coupled amplifier, the load resistance of the tube is approximately equal to the resistance of the plate resistor in parallel with the grid resistor of the following stage. Hence, to obtain a large value of load resistance, it is necessary to use a plate resistor and a grid resistor of large resistance. However, the plate resistor should not be too large because the flow of plate current through the plate resistor produces a voltage drop which reduces the plate voltage applied to the tube. If the plate resistor is too large, this drop will be too large, the plate voltage on the tube will be too small, and the voltage output of the tube will be too small. Also, the grid resistor of the following stage should not be too large, the actual maximum value being dependent on the particular tube type. This precaution is necessary because all tubes contain minute amounts of residual gas which cause a minute flow of current through the grid resistor. If the grid resistor is too large, the positive bias developed by the flow of this current through the resistor decreases the normal negative bias and produces an increase in the plate current. This increased current may overheat the tube and cause liberation of more gas which, in turn, will cause further decrease in bias. The action is cumulative and results in a runaway condition which can destroy the tube.

A higher value of grid resistance is permissible when cathode-resistor bias is used than when fixed bias is used. When cathode-resistor bias is used, a loss in bias due to gas or grid-emission



effects is almost completely offset by an increase in bias due to the voltage drop across the cathode resistor. Typical values of plate resistor and grid resistor for tube types used in resistance-coupled circuits, and the values of gain obtainable, are shown in the RESISTANCE-COUPLED AMPLIFIER SECTION.

The input impedance of an electron tube (that is, the impedance between grid and cathode) consists of (1) a reactive component due to the capacitance

frequencies to affect appreciably the gain and selectivity of a preceding stage. Tubes such as the "acorn" and "pencil" types and the high-frequency miniatures have been developed to have low input capacitances, low electron-transit time, and low lead inductance so that their input impedance is high even at the ultra-high radio frequencies. **Input admittance** is the reciprocal of input impedance.

A remote-cutoff amplifier tube is

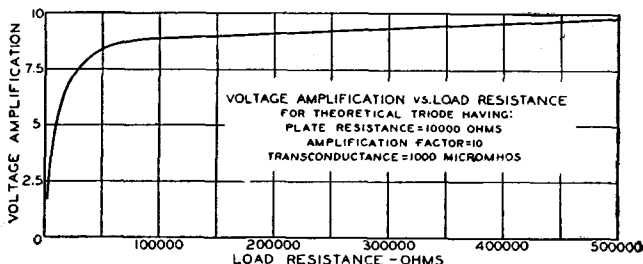

Fig. 15

between grid and cathode, (2) a resistive component resulting from the time of transit of electrons between cathode and grid, and (3) a resistive component developed by the part of the cathode lead inductance which is common to both the input and output circuits. Components (2) and (3) are dependent on the frequency of the incoming signal. The input impedance is very high at audio frequencies when a tube is operated with its grid biased negative. In a class  $A_1$  or  $AB_1$  transformer-coupled audio amplifier, therefore, the loading imposed by the grid on the input transformer is negligible. As a result, the secondary impedance of a class  $A_1$  or class  $AB_1$  input transformer can be made very high because the choice is not limited by the input impedance of the tube; however, transformer design considerations may limit the choice.

At the higher radio frequencies, the input impedance may become very low even when the grid is negative, due to the finite time of passage of electrons between cathode and grid and to the appreciable lead reactance. This impedance drops very rapidly as the frequency is raised, and increases input-circuit loading. In fact, the input impedance may become low enough at very high radio

a modified construction of a pentode or a tetrode type designed to reduce modulation-distortion and cross-modulation in radio-frequency stages. **Cross-modulation** is the effect produced in a radio or television receiver by an interfering station "riding through" on the carrier of the station to which the receiver is tuned. **Modulation-distortion** is a distortion of the modulated carrier and appears as audio-frequency distortion in the output. This effect is produced by a radio-frequency amplifier stage operating on an excessively curved characteristic when the grid bias has been increased to reduce volume. The offending stage for cross-modulation is usually the first radio-frequency amplifier, while for modulation-distortion the cause is usually the last intermediate-frequency stage. The characteristics of remote-cutoff types are such as to enable them to handle both large and small input signals with minimum distortion over a wide range of signal strength.

Fig. 16 illustrates the construction of the grid No.1 (control grid) in a remote-cutoff tube. The remote-cutoff action is due to the structure of the grid which provides a variation in amplification factor with change in grid bias. The grid No.1 is wound with open spacing at

the middle and with close spacing at the ends. When weak signals and low grid bias are applied to the tube, the effect of the non-uniform turn spacing of the grid on cathode emission and tube characteristics is essentially the same as for uniform spacing. As the grid bias is made more negative to handle larger input

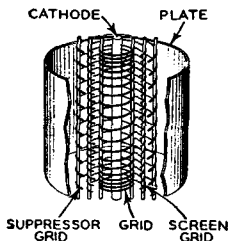

Fig. 16

signals, the electron flow from the sections of the cathode enclosed by the ends of the grid is cut off. The plate current and other tube characteristics are then dependent on the electron flow through the open section of the grid. This action changes the gain of the tube so that large signals may be handled with minimum distortion due to cross-modulation and modulation-distortion.

Fig. 17 shows a typical plate-current vs. grid-voltage curve for a remote-cutoff type compared with the curve for a type having a uniformly spaced grid. It will be noted that while the curves are similar at small grid-bias voltages, the plate current of the remote-cutoff tube drops quite slowly with large values of bias voltage. This slow change makes it

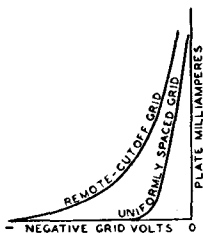

Fig. 17

possible for the tube to handle large signals satisfactorily. Because remote-cutoff types can accommodate large and small signals, they are particularly suitable for use in sets having automatic volume control. Remote-cutoff tubes also are known as variable- $\mu$  types.

### Class A Power Amplifiers

As a class A power amplifier, an electron tube is used in the output stage of a radio or television receiver to supply a relatively large amount of power to the loudspeaker. For this application, large power output is of more importance than high voltage amplification; therefore, gain possibilities are sacrificed in the design of power tubes to obtain power-handling capability.

Triodes, pentodes, and beam power tubes designed for power amplifier service have certain inherent features for each structure. Power tubes of the triode type for class A service are characterized by low power sensitivity, low plate-power efficiency, and low distortion. Power tubes of the pentode type are characterized by high power sensitivity, high plate-power efficiency and, usually, somewhat higher distortion than class A triodes. Beam power tubes have higher

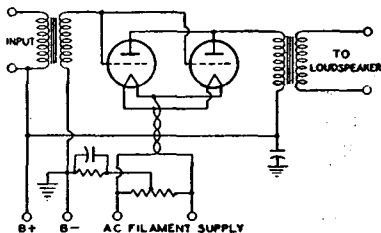

Fig. 18

power sensitivity and efficiency than triode or conventional pentode types.

A class A power amplifier is also used as a driver to supply power to a class  $AB_2$  or a class B stage. It is usually advisable to use a triode, rather than a pentode, in a driver stage because of the lower plate impedance of the triode.

Power tubes connected in either parallel or push-pull may be employed as class A amplifiers to obtain increased output. The parallel connection (Fig. 18) provides twice the output of a single tube with the same value of grid-signal voltage. With this connection, the effective transconductance of the stage is doubled, and the effective plate resistance and the load resistance required are halved as compared with single-tube values.

The push-pull connection (Fig. 19), although it requires twice the grid-signal

voltage, provides increased power and has other important advantages over single-tube operation. Distortion caused by even-order harmonics and hum caused

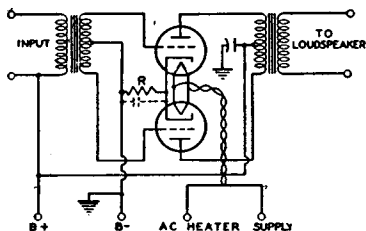

Fig. 19

by plate-voltage-supply fluctuations are either eliminated or decidedly reduced through cancellation. Because distortion for push-pull operation is less than for single-tube operation, appreciably more than twice single-tube output can be obtained with triodes by decreasing the load resistance for the stage to a value approaching the load resistance for a single tube.

For either parallel or push-pull class A operation of two tubes, all electrode currents are doubled while all dc electrode voltages remain the same as for single-tube operation. If a cathode resistor is used, its value should be about one-half that for a single tube. If oscillations occur with either type of connection, they can often be eliminated by the use of a non-inductive resistor of approximately 100 ohms connected in series with each grid at the socket terminal.

Operation of power tubes so that

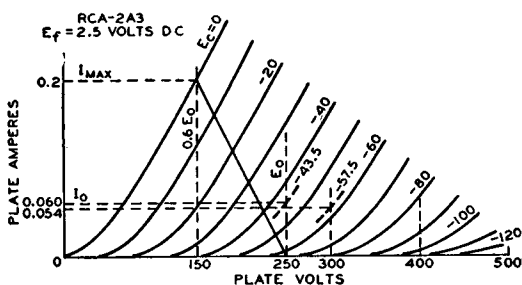

Fig. 20

the grids run positive is inadvisable except under conditions such as those discussed in this section for class AB and class B amplifiers.

### Power-Output Calculations

Calculation of the power output of a triode used as a class A amplifier with either an output transformer or a choke having low dc resistance can be made without serious error from the plate family of curves by assuming a resistance load. The proper plate current, grid bias, optimum load resistance, and per-cent second-harmonic distortion can also be determined. The calculations are made graphically and are illustrated in Fig. 20 for given conditions. The procedure is as follows:

(1) Locate the zero-signal bias point P by determining the zero-signal bias  $E_{c0}$  from the formula:

$$\text{Zero-signal bias } (E_{c0}) = -(0.68 \times E_b) / \mu$$

where  $E_b$  is the chosen value in volts of dc plate voltage at which the tube is to be operated, and  $\mu$  is the amplification factor of the tube. This quantity is shown as negative to indicate that a negative bias is used.

(2) Locate the value of zero-signal plate current,  $I_0$ , corresponding to point P.

(3) Locate the point  $2I_0$ , which is twice the value of  $I_0$  and corresponds to the value of the maximum-signal plate current  $I_{max}$ .

(4) Locate the point X on the dc bias curve at zero volts,  $E_c = 0$ , corresponding to the value of  $I_{max}$ .

(5) Draw a straight line XY through X and P.

Line XY is known as the load resistance line. Its slope corresponds to

the value of the load resistance. The load resistance in ohms is equal to  $(E_{max} - E_{min})$  divided by  $(I_{max} - I_{min})$ , where E is in volts and I is in amperes.

It should be noted that in the case of filament types of tubes, the calculations are given on the basis of a dc-operated filament. When the filament is ac-operated, the calculated value of dc bias should be increased by approximately one-half the filament voltage rating of the tube.

The value of zero-signal plate current  $I_0$  should be used to determine the plate dissipation, an important factor influencing tube life. In a class A amplifier under zero-signal conditions, the plate dissipation is equal to the power input, *i.e.*, the product of the dc plate voltage  $E_0$  and the zero-signal dc plate current  $I_0$ . If it is found that the plate-dissipation rating of the tube is exceeded with the zero-signal bias  $E_0$ , calculated above, it will be necessary to increase the bias by a sufficient amount so that the actual plate dissipation does not exceed the rating before proceeding further with the remaining calculations.

For power-output calculations, it is assumed that the peak alternating grid voltage is sufficient (1) to swing the grid from the zero-signal bias value  $E_0$  to zero bias ( $E_c = 0$ ) on the positive swing and (2) to swing the grid to a value twice the zero-signal bias value on the negative swing. During the negative swing, the plate voltage and plate current reach values of  $E_{max}$  and  $I_{min}$ ; during the positive swing, they reach values of  $E_{min}$  and  $I_{max}$ . Because power is the product of voltage and current, the power output  $P_0$  as shown by a wattmeter is given by

$$P_0 = \frac{(I_{max} - I_{min}) \times (E_{max} - E_{min})}{8}$$

where  $E$  is in volts,  $I$  is in amperes, and  $P_0$  is in watts.

In the output of power amplifier triodes, some distortion is present. This distortion is due predominantly to second harmonics in single-tube amplifiers. The percentage of second-harmonic distortion may be calculated by the following formula:

$$\% \text{ distortion} = \frac{\frac{I_{max} + I_{min}}{2} - I_0}{I_{max} - I_{min}} \times 100$$

where  $I_0$  is the zero-signal plate current in amperes. If the distortion is excessive, the load resistance should be increased or, occasionally, decreased slightly and

the calculations repeated.

**Example:** Determine the load resistance, power output, and distortion of a triode having an amplification factor of 4.2, a plate-dissipation rating of 15 watts, and plate characteristics curves as shown in Fig. 20. The tube is to be operated at 250 volts on the plate.

**Procedure:** For a first approximation, determine the operating point P from the zero-signal bias formula,  $E_0 = -(0.68 \times 250) / 4.2 = -40.5$  volts. From the curve for this voltage, it is found that the zero-signal plate current  $I_0$  at a plate voltage of 250 volts is 0.08 ampere and, therefore, the plate-dissipation rating is exceeded ( $0.08 \times 250 = 20$  watts). Consequently, it is necessary to reduce the zero-signal plate current to 0.06 ampere at 250 volts. The grid bias is now seen to be -43.5 volts. Note that the curve was taken with a dc filament supply; if the filament is to be operated on an ac supply, the bias must be increased by about one-half the filament voltage, or to -45 volts, and the circuit returns made to the mid-point of the filament circuit.

Point X can now be determined. Point X is at the intersection of the dc bias curve at zero volts with  $I_{max}$ , where  $I_{max} = 2I_0 = 2 \times 0.06 = 0.12$  ampere. Line XY is drawn through points P and X.  $E_{max}$ ,  $E_{min}$ , and  $I_{min}$  are then found from the curves. Substituting these values in the power-output formula, we obtain

$$P_0 = \frac{(0.12 - 0.012) \times (365 - 105)}{8} = 3.52 \text{ watts}$$

The resistance represented by load line XY is

$$\frac{(365 - 105)}{(0.12 - 0.012)} = 2410 \text{ ohms}$$

When the values from the curves are substituted in the distortion formula, we obtain

$$\% \text{ distortion} = \frac{0.12 + 0.012}{2} - 0.06 \div \frac{0.12 - 0.012}{2} \times 100 = 5.5\%$$

It is customary to select the load resistance so that the distortion does not exceed five per cent. When the method shown is used to determine the slope of the load resistance line, the second-harmonic distortion generally does not exceed five per cent. In the example, however, the distortion is excessive and it is desirable, therefore, to use a slightly

higher load resistance. A load resistance of 2500 ohms will give a distortion of about 4.9 per cent. The power output is reduced only slightly to 3.5 watts.

Operating conditions for triodes in push-pull depend on the type of operation desired. Under class A conditions, distortion, power output, and efficiency are all relatively low. The operating bias can be anywhere between that specified for single-tube operation and that equal to one-half the grid-bias voltage required to produce plate-current cutoff at a plate voltage of  $1.4E_0$  where  $E_0$  is the operating plate voltage. Higher bias than this value requires higher grid-signal voltage and results in class AB<sub>1</sub> operation which is discussed later.

The method for calculating maximum power output for triodes in push-pull class A operation is as follows: Erect a vertical line at  $0.6 E_0$  (see Fig. 21), intersecting the  $E_0=0$  curve at the

plate dissipation rating of the tube is 15 watts. Then, for class A operation, the operating bias can be equal to, but not more than, one-half the grid bias for cutoff with a plate voltage of  $1.4 \times 300 = 420$  volts. (Since cutoff bias is approximately -115 volts at a plate voltage of 420 volts, one-half of this value is -57.5 volts bias.) At this bias, the plate current is found from the plate family to be 0.054 ampere and, therefore, the plate dissipation is  $0.054 \times 300$  or 16.2 watts. Since -57.5 volts is the limit of bias for class A operation of these tubes at a plate voltage of 300 volts, the dissipation cannot be reduced by increasing the bias and it, therefore, becomes necessary to reduce the plate voltage.

If the plate voltage is reduced to 250 volts, the bias will be found to be -43.5 volts. For this value, the plate current is 0.06 ampere, and the plate dissipation is 15 watts. Then, following the

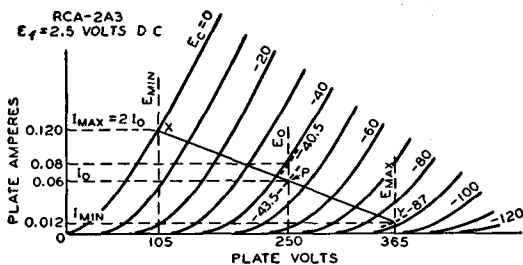

Fig. 21

point  $I_{max}$ . Then,  $I_{max}$  is determined from the curve for use in the formula

$$P_o = (I_{max} \times E_0) / 5$$

If  $I_{max}$  is expressed in amperes and  $E_0$  in volts, power output is in watts.

The method for determining the proper load resistance for triodes in push-pull is as follows: Draw a load line through  $I_{max}$  on the zero-bias curve and through the  $E_0$  point on the zero-current axis. Four times the resistance represented by this load line is the plate-to-plate load ( $R_{pp}$ ) for two triodes in a class A push-pull amplifier. Expressed as a formula,

$$R_{pp} = 4 \times (E_0 - 0.6E_0) / I_{max}$$

where  $E_0$  is expressed in volts,  $I_{max}$  in amperes, and  $R_{pp}$  in ohms.

**Example:** Assume that the plate voltage ( $E_0$ ) is to be 300 volts, and the

method for calculating power output, erect a vertical line at  $0.6E_0 = 150$  volts. The intersection of the line with the curve  $E_g = 0$  is  $I_{max}$  or 0.2 ampere. When this value is substituted in the power formula, the power output is  $(0.2 \times 250) / 5 = 10$  watts. The load resistance is determined from the load formula: Plate-to-plate load ( $R_{pp}$ ) =  $4 \times (250 - 150) / 0.2 = 2000$  ohms.

**Power output for a pentode or a beam power tube as a class A amplifier** can be calculated in much the same way as for triodes. The calculations can be made graphically from a special plate family of curves, as illustrated in Fig. 22.

From a point A at or just below the knee of the zero-bias curve, draw arbitrarily selected load lines to intersect the zero-plate-current axis. These lines should be on both sides of the operating

point P whose position is determined by the desired operating plate voltage,  $E_o$ , and one-half the maximum-signal plate current. Along any load line, say  $AA_1$ , measure the distance  $AO_1$ . On the same line, lay off an equal distance,  $O_1A_1$ . For optimum operation, the change in bias from A to  $O_1$  should be nearly equal to the change in bias from  $O_1$  to  $A_1$ . If this condition can not be met with one line,

$$\% \text{ total (2nd and 3rd) harmonic distortion} = \sqrt{(\%2nd)^2 + (\%3rd)^2}$$

### Conversion Factors

Operating conditions for voltage values other than those shown in the published data can be obtained by the use of the nomograph shown in Fig. 23 when all electrode voltages are changed simultaneously in the same ratio. The

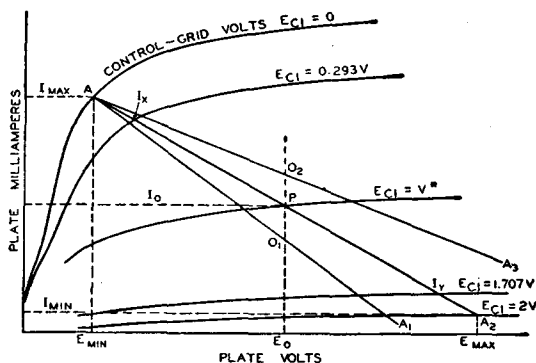

Fig. 22

as is the case for the line first chosen, then another should be chosen. When the most satisfactory line has been selected, its resistance may be determined by the following formula:

$$\text{Load resistance (R}_L\text{)} = \frac{E_{\text{max}} - E_{\text{min}}}{I_{\text{max}} - I_{\text{min}}}$$

The value of  $R_L$  may then be substituted in the following formula for calculating power output.

$$P_o = \frac{[I_{\text{max}} - I_{\text{min}} + 1.41 (I_x - I_y)]^2 R_L}{32}$$

In both of these formulas,  $I$  is in amperes,  $E$  is in volts,  $R_L$  is in ohms, and  $P_o$  is in watts.  $I_x$  and  $I_y$  are the current values on the load line at bias voltages of  $E_{c1} = V - 0.707V = 0.293V$  and  $E_{c1} = V + 0.707V = 1.707V$ , respectively.

Calculations for distortion may be made by means of the following formulas. The terms used have already been defined.

$$\% \text{ 2nd-harmonic distortion} = \frac{I_{\text{max}} + I_{\text{min}} - 2 I_o}{I_{\text{max}} - I_{\text{min}} + 1.41 (I_x - I_y)} \times 100$$

$$\% \text{ 3rd-harmonic distortion} = \frac{I_{\text{max}} - I_{\text{min}} - 1.41 (I_x - I_y)}{I_{\text{max}} - I_{\text{min}} + 1.41 (I_x - I_y)} \times 100$$

nomograph includes conversion factors for current ( $F_i$ ), power output ( $F_p$ ), plate resistance or load resistance ( $F_r$ ), and transconductance ( $F_{gm}$ ) for voltage ratios between 0.5 and 2.0. These factors are expressed as functions of the ratio between the desired or new voltage for any electrode ( $E_{\text{des}}$ ) and the published or original value of that voltage ( $E_{\text{pub}}$ ). The relations shown are applicable to triodes and multigrad tubes in all classes of service.

To use the nomograph, simply place a straight-edge across the page so that it intersects the scales for  $E_{\text{des}}$  and  $E_{\text{pub}}$  at the desired values. The desired conversion factor may then be read directly or estimated at the point where the straight-edge intersects the  $F_i$ ,  $F_p$ ,  $F_r$ , or  $F_{gm}$  scale.

For example, suppose it is desired to operate two 6L6-G's in class A<sub>1</sub> push-pull, fixed bias, with a plate voltage of 200 volts. The nearest published operating conditions for this class of service are for a plate voltage of 250 volts. The operating conditions for the new plate voltage can be determined as follows:

The voltage conversion factor,  $F_e$ ,

is equal to 200/250 or 0.8. The dashed lines on the nomograph of Fig. 23 indicate that for this voltage ratio  $F_i$  is approximately 0.72,  $F_p$  is approximately

Because contact-potential effects become noticeable only at very small dc grid-No.1 (bias) voltages, they are generally negligible in power tubes. Secondary

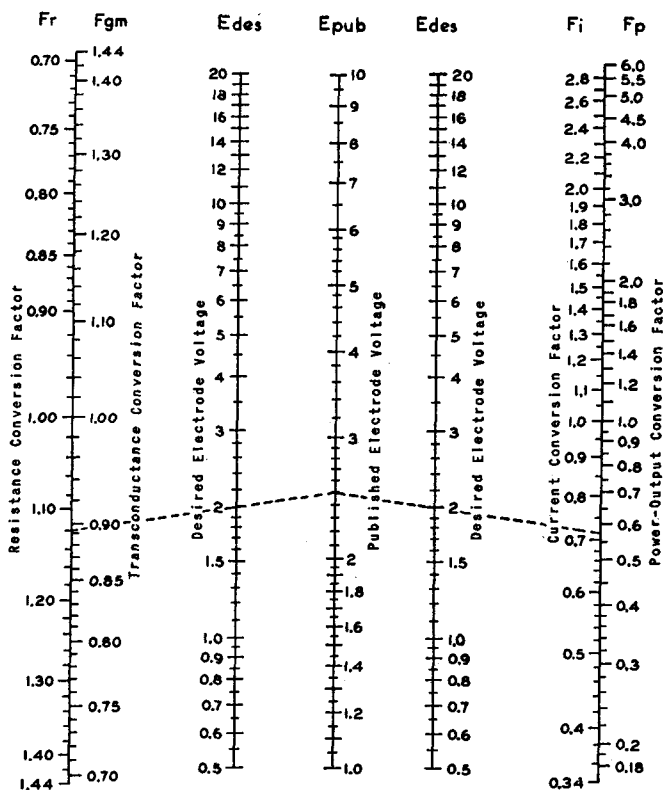

Fig. 23

0.57,  $F_r$  is 1.12, and  $F_{gm}$  is approximately 0.892. These factors may be applied directly to operating values shown in the tube data, or to values calculated by the methods described previously.

Because this method for conversion of characteristics is necessarily an approximation, the accuracy of the nomograph decreases progressively as the ratio  $E_{des}/E_{pub}$  departs from unity. In general, results are substantially correct when the value of the ratio  $E_{des}/E_{pub}$  is between 0.7 and 1.5. Beyond these limits, the accuracy decreases rapidly, and the results obtained must be considered rough approximations.

The nomograph does not take into consideration the effects of contact potential or secondary emission in tubes.

emission may occur in conventional tetrodes, however, if the plate voltage swings below the grid-No.2 voltage. Consequently, the conversion factors shown in the nomograph apply to such tubes only when the plate voltage is greater than the grid-No.2 voltage. Because secondary emission may also occur in certain beam power tubes at very low values of plate current and plate voltage, the conversion factors shown in the nomograph do not apply when these tubes are operated under such conditions.

### Class AB Power Amplifiers

A class AB power amplifier employs two tubes connected in push-pull with a higher negative grid bias than is

used in a class A stage. With this higher negative bias, the plate and screen-grid voltages can usually be made higher than for class A amplifiers because the increased negative bias holds plate current within the limit of the tube's plate-dissipation rating. As a result of these higher voltages, more power output can be obtained from class AB operation.

Class AB amplifiers are subdivided into class AB<sub>1</sub> and class AB<sub>2</sub>. In class AB<sub>1</sub> there is no flow of grid current. That is, the peak signal voltage applied to each grid is not greater than the negative grid-bias voltage. The grids therefore are not driven to a positive potential and do not draw current. In class AB<sub>2</sub>, the peak signal voltage is greater than the bias so that the grids are driven positive and draw current.

Because of the flow of grid current in a class AB<sub>2</sub> stage there is a loss of

fluctuations in the voltage output of the power supply, with the result that power output is decreased and distortion is increased. To obtain satisfactory regulation it is usually advisable to use a low-drop rectifier, such as the 5V4-G, with a choke-input filter. In all cases, the resistance of the filter choke and power transformers should be as low as possible.

### Class AB<sub>1</sub> Power Amplifiers

In class AB<sub>1</sub> push-pull amplifier service using triodes, the operating conditions may be determined graphically by means of the plate family if  $E_c$ , the desired operating plate voltage, is given. In this service, the dynamic load line does not pass through the operating point P as in the case of the single-tube amplifier, but through the point D in Fig. 24. Its position is not affected by the operating grid bias provided the

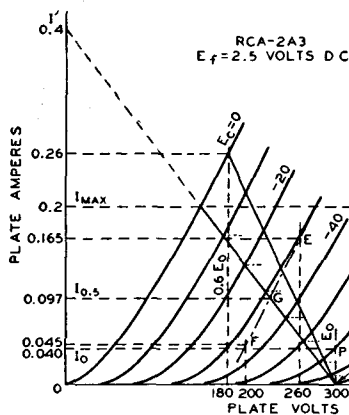

Fig. 24

power in the grid circuit. The sum of this loss and the loss in the input transformer is the total driving power required by the grid circuit. The driver stage should be capable of a power output considerably larger than this required power in order that distortion introduced in the grid circuit be kept low. The input transformer used in a class AB<sub>2</sub> amplifier usually has a step-down turns ratio.

Because of the large fluctuations of plate current in a class AB<sub>2</sub> stage, it is important that the plate power supply should have good regulation. Otherwise the fluctuations in plate current cause

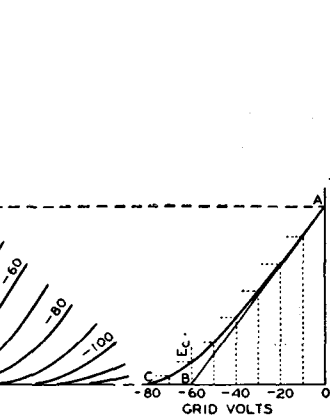

Fig. 25

plate-to-plate load resistance remains constant.

Under these conditions, grid bias has no appreciable effect on the power output. Grid bias cannot be neglected, however, since it is used to find the zero-signal plate current and, from it, the zero-signal plate dissipation. Because the grid bias is higher in class AB<sub>1</sub> than in class A service for the same plate voltage, a higher signal voltage may be used without grid current being drawn and, therefore, higher power output is obtained than in class A service.

In general, for any load line through point D, Fig. 24, the plate-to-plate load



resistance in ohms of a push-pull amplifier is  $R_{pp} = 4E_o/I'$ , where  $I'$  is the plate current value in amperes at which the load line as projected intersects the plate current axis, and  $E_o$  is in volts. This formula is another form of the one given under push-pull class A amplifiers,  $R_{pp} = 4(E_o - 0.6E_o)/I_{max}$ , but is more general. Power output =  $(I_{max}/\sqrt{2})^2 \times R_{pp}/4$ , where  $I_{max}$  is the peak plate current at zero grid volts for the load chosen. This formula simplified is  $(I_{max})^2 \times R_{pp}/8$ . The maximum-signal average plate current is  $2I_{max}/\pi$  or  $0.636 I_{max}$ ; the maximum-signal average power input is  $0.636 I_{max} \times E_o$ .

It is desirable to simplify these formulas for a first approximation. This simplification can be made if it is assumed that the peak plate current,  $I_{max}$ , occurs at the point of the zero-bias curve corresponding approximately to  $0.6 E_o$ , the condition for maximum power output. The simplified formulas are:

$$P_o \text{ (for two tubes)} = (I_{max} \times E_o)/5$$

$$R_{pp} = 1.6E_o/I_{max}$$

where  $E_o$  is in volts,  $I_{max}$  is in amperes,  $R_{pp}$  is in ohms, and  $P_o$  is in watts.

It may be found during subsequent calculations that the distortion or the plate dissipation is excessive for this approximation; in that case, a different load resistance must be selected using the first approximation as a guide and the process repeated to obtain satisfactory operating conditions.

**Example:** Fig. 24 illustrates the application of this method to a pair of 2A3's operated at  $E_o=300$  volts. Each tube has a plate-dissipation rating of 15 watts. The method is to erect a vertical line at  $0.6E_o$ , or at 180 volts, which intersects the  $E_c=0$  curve at the point  $I_{max}=0.26$  ampere. Using the simplified formulas, we obtain

$$R_{pp} = (1.6 \times 300)/0.26 = 1845 \text{ ohms}$$

$$P_o = (0.26 \times 300)/5 = 15.6 \text{ watts}$$

At this point, it is well to determine the plate dissipation and to compare it with the maximum rated value. From the average plate current formula ( $0.636 I_{max}$ ) mentioned previously, the maximum-signal average plate current is 0.166 ampere. The product of this current and the operating plate voltage is 49.8 watts, the average input to the two

tubes. From this value, subtract the power output of 15.6 watts to obtain the total dissipation for both tubes which is 34.2 watts. Half of this value, 17 watts, is in excess of the 15-watt rating of the tube and it is necessary, therefore, to assume another and higher load resistance so that the plate-dissipation rating will not be exceeded.

It will be found that at an operating plate voltage of 300 volts the 2A3's require a plate-to-plate load resistance of 3000 ohms. From the formula for  $R_{pp}$ , the value of  $I'$  is found to be 0.4 ampere. The load line for the 3000-ohm load resistance is then represented by a straight line from the point  $I'=0.4$  ampere on the plate-current ordinate to the point  $E_o=300$  volts on the plate-voltage abscissa. At the intersection of the load line with the zero-bias curve, the peak plate current,  $I_{max}$ , can be read at 0.2 ampere. Then

$$P_o = (I_{max}/\sqrt{2})^2 R_{pp}/4$$

$$= (0.2/1.41)^2 \times 3000/4$$

$$= 15 \text{ watts}$$

Proceeding as in the first approximation, we find that the maximum-signal average plate current,  $0.636I_{max}$ , is 0.127 ampere, and the maximum-signal average power input is 38.1 watts. This input minus the power output is  $38.1 - 15 = 23.1$  watts. This value is the dissipation for two tubes; the value per tube is 11.6 watts, a value well within the rating of this tube type.

The operating bias and the zero-signal plate current may now be found by use of a curve which is derived from the plate family and the load line. Fig. 25 is a curve of instantaneous values of plate current and dc grid-bias voltages taken from Fig. 24. Values of grid bias are read from each of the grid-bias curves of Fig. 24 along the load line and are transferred to Fig. 25 to produce the curved line from A to C. A tangent to this curve, starting at A, is drawn to intersect the grid-voltage abscissa. The point of intersection, B, is the operating grid bias for fixed-bias operation. In the example, the bias is -60 volts. Refer back to the plate family at the operating conditions of plate volts=300 and grid bias= -60 volts; the zero-signal plate current per tube is seen to be 0.04 ampere.

This procedure locates the operating point for each tube at P. The plate current must be doubled, of course, to obtain the zero-signal plate current for both tubes. Under maximum-signal conditions, the signal voltage swings from zero-signal bias voltage to zero bias for each tube on alternate half cycles. Hence, in the example, the peak of signal voltage per tube is 60 volts, or the grid-to-grid value is 120 volts.

As in the case of the push-pull class A amplifier, the second-harmonic distortion in a class AB<sub>1</sub> amplifier using triodes is very small and is largely canceled by virtue of the push-pull connection. Third-harmonic distortion, however, which may be larger than permissible, can be found by means of composite characteristic curves. A complete family of curves can be plotted, but for the present purpose only the one corresponding to a grid bias of one-half the peak grid-voltage swing is needed. In the example, the peak grid voltage per tube is 60 volts, and the half value is 30 volts. The composite curve, since it is nearly a straight line, can be constructed with only two points (see Fig. 24). These two points are obtained from deviations above and below the operating grid and plate voltages.

In order to find the curve for a bias of -30 volts, we have assumed a deviation of 30 volts from the operating grid voltage of -60 volts. Next assume a deviation from the operating plate voltage of, say, 40 volts. Then at 300 - 40 = 260 volts, erect a vertical line to intersect the (-60) - (-30) = -30-volt bias curve and read the plate current at this intersection, which is 0.167 ampere; likewise, at the intersection of a vertical line at 300 + 40 = 340 volts and the (-60) + (-30) = -90-volt bias curve, read the plate current. In this example, the plate current is estimated to be 0.002 ampere. The difference of 0.165 ampere between these two currents determines the point E on the 300 - 40 = 260-volt vertical. Similarly, another point F on the same composite curve is found by assuming the same grid-bias deviation but a larger plate-voltage deviation, say, 100 volts.

We now have points at 260 volts and 0.165 ampere (E), and at 200 volts and 0.045 ampere (F). A straight line

through these points is the composite curve for a bias of -30 volts, shown as a long-short dash line in Fig. 24. At the intersection of the composite curve and the load line, G, the instantaneous composite plate current at the point of one-half the peak signal swing is determined. This current value, designated  $I_{0.5}$  and the peak plate current,  $I_{max}$ , are used in the following formula to find peak value of the third-harmonic component of the plate current.

$$I_{h_3} = (2I_{0.5} - I_{max})/3$$

In the example, where  $I_{0.5}$  is 0.097 ampere and  $I_{max}$  is 0.2 ampere,  $I_{h_3} = (2 \times 0.097 - 0.2)/3 = (0.194 - 0.2)/3 = -0.006/3 = -0.002$  ampere. (The fact that  $I_{h_3}$  is negative indicates that the phase relation of the fundamental (first-harmonic) and third-harmonic components of the plate current is such as to result in a slightly peaked wave form.  $I_{h_3}$  is positive in some cases, indicating a flattening of the wave form.)

The peak value of the fundamental or first-harmonic component of the plate current is found by the following formula:

$$I_{h_1} = 2/3 \times (I_{max} + I_{0.5})$$

In the example,  $I_{h_1} = 2/3 \times (0.2 + 0.097) = 0.198$  ampere. Thus, the percentage of third-harmonic distortion is  $(I_{h_3}/I_{h_1}) \times 100 = (0.002/0.198) \times 100 = 1$  per cent approx.

### Class AB<sub>2</sub> Power Amplifiers

A class AB<sub>2</sub> amplifier employs two tubes connected in push-pull as in the case of class AB<sub>1</sub> amplifiers. It differs in that it is biased so that plate current flows for somewhat more than half the electrical cycle but less than the full cycle, the peak signal voltage is greater than the dc bias voltage, grid current is drawn, and consequently, power is consumed in the grid circuit. These conditions permit high power output to be obtained without excessive plate dissipation.

The sum of the power used in the grid circuit and the losses in the input transformer is the total driving power required by the grid circuit. The driver stage should be capable of a power output considerably larger than this required power in order that distortion

introduced in the grid circuit be kept low. In addition, the internal impedance of the driver stage as reflected into or as effective in the grid circuit of the power stage should always be as low as possible in order that distortion may be kept low. The input transformer used in a class AB<sub>2</sub> stage usually has a step-down ratio adjusted for this condition.

Load resistance, plate dissipation, power output, and distortion determinations are similar to those for class AB<sub>1</sub>. These quantities are interdependent with peak grid-voltage swing and driving power; a satisfactory set of operating conditions involves a series of approximations. The load resistance and signal swing are limited by the permissible grid current and power, and the distortion. If the load resistance is too high or the signal swing is excessive, the plate-dissipation rating will be exceeded, distortion will be high, and the driving power will be unnecessarily high.

### Class B Power Amplifiers

A class B amplifier employs two tubes connected in push-pull, so biased that plate current is almost zero when no signal voltage is applied to the grids. Because of this low value of no-signal plate current, class B amplification has the same advantage as class AB<sub>2</sub>, *i.e.*, large power output can be obtained without excessive plate dissipation. Class B operation differs from class AB<sub>2</sub> in that plate current is cut off for a larger portion of the negative grid swing, and the signal swing is usually larger than in class AB<sub>2</sub> operation.

Because tubes designed for use as class B amplifiers usually operate at zero or low bias, each grid is at a positive potential during all or most of the positive half-cycle of its signal swing and consequently draws considerable grid current. There is, therefore, a loss of power in the grid circuit. This condition imposes the same requirement in the driver stage as in a class AB<sub>2</sub> stage, that is, the driver should be capable of delivering considerably more power output than the power required for the class B grid circuit in order that distortion be low. Likewise, the interstage transformer between the driver and class B stage usually has a step-down turns ratio.

Determination of load resistance, plate dissipation, power output, and distortion is similar to that for a class AB<sub>2</sub> stage.

Power amplifier tubes designed for class A operation can be used in class AB<sub>2</sub> and class B service under suitable operating conditions. There are several tube types designed especially for class B service. The characteristic common to all of these types is a high amplification factor. With a high amplification factor, plate current is small even when the grid bias is zero. These tubes, therefore, can be operated in class B service at a bias of zero volts so that no bias supply is required. A number of class B amplifier tubes consist of two triode units mounted in one tube. The two units can be connected in push-pull so that only one tube is required for a class B stage. Examples of twin triodes used in class B service are the 6N7 and 1G6-GT.

### Cathode-Drive Circuits

The preceding text has discussed the use of tubes in the conventional grid-drive type of amplifier—that is, where the cathode is common to both the input and output circuits. Tubes may also be employed as amplifiers in circuit arrangements which utilize the grid or plate as the common terminal. Probably the most important of these amplifiers are the cathode-drive circuit, which is discussed below, and the cathode-follower circuit, which will be discussed later in connection with inverse feedback.

A typical cathode-drive circuit is shown in Fig. 26. The load is placed in

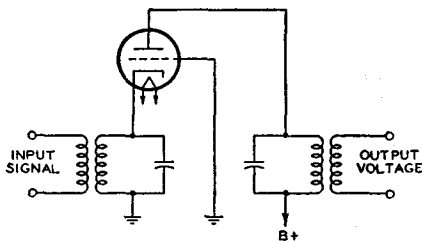

Fig. 26

the plate circuit and the output voltage is taken off between the plate and ground as in the grid-drive method of operation. The grid is grounded, and the input

voltage is applied across an appropriate impedance in the cathode circuit. The cathode-drive circuit is particularly useful for vhf and uhf applications, in which it is necessary to obtain the low-noise performance usually associated with a triode, but where a conventional grid-drive circuit would be unstable because of feedback through the grid-to-plate capacitance of the tube. In the cathode-drive circuit, the grounded grid serves as a capacitive shield between plate and cathode and permits stable operation at frequencies higher than those in which conventional circuits can be used.

The input impedance of a cathode-drive circuit is approximately equal to  $1/g_m$  when the load resistance is small compared to the  $r_p$  of the tube. A certain amount of power is required, therefore, to drive such a circuit. However, in the type of service in which cathode-drive circuits are normally used, the advantages of the grounded-grid connection usually outweigh this disadvantage.

### Inverse Feedback

An inverse-feedback circuit, sometimes called a degenerative circuit, is one in which a portion of the output voltage of a tube is applied to the input of the same or a preceding tube in opposite phase to the signal applied to the tube. Two important advantages of feedback are: (1) reduced distortion from each stage included in the feedback circuit and (2) reduction in the variations in gain due to changes in line voltage, possible differences between tubes of the same type, or variations in the values of circuit constants included in the feedback circuit.

Inverse feedback is used in audio amplifiers to reduce distortion in the output stage where the load impedance on the tube is a loudspeaker. Because the impedance of a loudspeaker is not constant for all audio frequencies, the load impedance on the output tube varies with frequency. When the output tube is a pentode or beam power tube having high plate resistance, this variation in plate load impedance can, if not corrected, produce considerable frequency distortion. Such frequency distortion can be reduced by means of inverse feedback. Inverse-feedback circuits are

of the constant-voltage type and the constant-current type.

The application of the constant-voltage type of inverse feedback to a power output stage using a single beam power tube is illustrated by Fig. 27. In this circuit,  $R_1$ ,  $R_2$ , and  $C$  are connected as a voltage divider across the output of the tube. The secondary of the grid-input transformer is returned to a point on this voltage divider. Capacitor  $C$  blocks the dc plate voltage from the grid. However, a portion of the tube's af output voltage, approximately equal to the output voltage multiplied by the fraction  $R_2/(R_1 + R_2)$ , is applied to the grid. This voltage lowers the source impedance of the circuit and a decrease in distortion results which is explained in the curves of Fig. 28.

Consider first the amplifier without the use of inverse feedback. Suppose that when a signal voltage  $e_s$  is applied to the grid the af plate current  $i'_p$  has an irregularity in its positive half-cycle. This irregularity represents a departure from the waveform of the input signal and is, therefore, distortion. For this

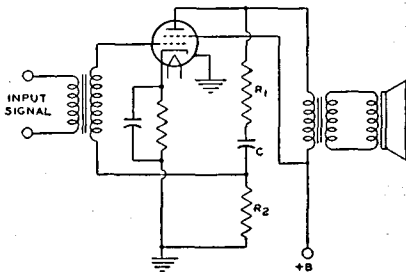

Fig. 27

plate-current waveform, the af plate voltage has a waveform shown by  $e'_p$ . The plate-voltage waveform is inverted compared to the plate-current waveform because a plate-current increase produces an increase in the drop across the plate load. The voltage at the plate is the difference between the drop across the load and the supply voltage; thus, when plate current goes up, plate voltage goes down; when plate current goes down, plate voltage goes up.

Now suppose that inverse feedback is applied to the amplifier. The voltage fed back to the grid has the same waveform and phase as the plate voltage, but



the output voltage rises at the resonant frequency of the loudspeaker and accentuates hangover effects.

Inverse feedback is not generally applied to a triode power amplifier, such as the 2A3, because the variation in speaker impedance with frequency does not produce much distortion in a triode stage having low plate resistance. It is sometimes applied in a pentode stage but is not always convenient. As has been shown, when inverse feedback is used in an amplifier, the driving voltage must be increased in order to give full power output. When inverse feedback is used with a pentode, the total driving voltage required for full power output may be inconveniently large, although still less than that required for a triode. Because a beam power tube gives full power output on a comparatively small driving voltage, inverse feedback is especially applicable to beam power tubes. By means of inverse feedback, the high efficiency and high power output of beam power tubes can be combined with freedom from the effects of varying speaker impedance.

### Cathode-Follower Circuits

Another important application of inverse feedback is in the cathode-follower circuit, an example of which is given in Fig. 30. In this application, the load has been transferred from the plate circuit to the cathode circuit of the tube. The input voltage is applied between the grid and ground and the output voltage is obtained between the cathode and ground. The voltage amplification (V.A.) of this circuit is always less than unity and may be expressed by the following convenient formulas.

For a triode:

$$V. A. = \frac{\mu \times R_L}{r_p + R_L \times (\mu + 1)}$$

For a pentode:

$$V. A. = \frac{g_m \times R_L}{1 + (g_m \times R_L)}$$

In these formulas,  $\mu$  is the amplification factor,  $R_L$  is the load resistance in ohms,  $r_p$  is the plate resistance in ohms, and  $g_m$  is the transconductance in mhos.

The use of the cathode follower permits the design of circuits which have high input resistance and high output

voltage. The output impedance is quite low and very low distortion may be obtained. Cathode-follower circuits may be used for power amplifiers or as impedance transformers designed either to match a transmission line or to produce a relatively high output voltage at a low impedance level.

In a power amplifier which is transformer coupled to the load, the same output power can be obtained from the tube as would be obtained in a conventional grid-drive type of amplifier. The output impedance is very low and provides excellent damping to the load, with the result that very low distortion can be obtained. The peak-to-peak signal voltage, however, approaches  $1\frac{1}{2}$  times the plate supply voltage if maximum power output is required from the tube. Some problems may be encountered, therefore, in the design of an ade-

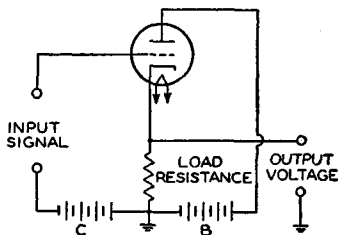

Fig. 30

quate driver stage for a cathode-follower output system.

When a cathode-follower circuit is used as an impedance transformer, the load is usually a simple resistance in the cathode circuit of the tube. With relatively low values of cathode resistor, the circuit may be designed to supply significant amounts of power and to match the impedance of the device to a transmission line. With somewhat higher values of cathode resistor, the circuit may be used to lower the output impedance sufficiently to permit the transmission of audio signals along a line in which appreciable capacitance is present.

The cathode follower may also be used as an isolation device to provide extremely high input resistance and low input capacitance as might be required in the probe of an oscilloscope or vacuum-tube voltmeter. Such circuits can be

designed to provide effective impedance transformation with no significant loss of voltage.

Selection of a suitable tube and its operating conditions for use in a cathode-follower circuit having a specified output impedance ( $Z_o$ ) can be made, in most practical cases, by the use of the following formula to determine the approximate value of the required tube transconductance.

$$\text{Required } g_m (\mu\text{mhos}) = \frac{1,000,000}{Z_o (\text{ohms})}$$

Once the required transconductance is obtained, a suitable tube and its operating conditions may be determined from the technical data given in the TUBE TYPES SECTION. The conversion nomograph given in Fig. 23 may be used for calculation of operating conditions for values of transconductance not included in the tabulated data. After the operating conditions have been determined, the approximate value of the required cathode load resistance may be calculated from the following formulas.

*For triode:*

$$\text{Cathode } R_L = \frac{Z_o \times r_p}{r_p - Z_o \times (1 + \mu)}$$

*For pentode:*

$$\text{Cathode } R_L = \frac{Z_o}{1 - (g_m \times Z_o)}$$

Resistance and impedance values are in ohms; transconductance values are in mhos.

If the value of the cathode load resistance calculated to give the required output impedance does not give the required operating bias, the basic cathode-follower circuit can be modified in a number of ways. Two of the more common modifications are given in Figs. 31 and 32.

In Fig. 31 the bias is increased by adding a bypassed resistance between the cathode and the unbypassed load resistance and returning the grid to the low end of the load resistance. In Fig. 32 the bias is reduced by adding a bypassed resistance between the cathode and the unbypassed load resistance but, in this case, the grid is returned to the junction of the two cathode resistors so that the bias voltage is only the dc voltage drop across the added resistance. The size of the bypass capacitor should be large

enough so that it has negligible reactance at the lowest frequency to be handled. In both cases the B-supply should be in-

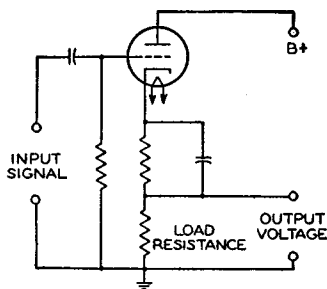

Fig. 31

creased to make up for the voltage taken for biasing.

**Example:** Select a suitable tube and determine the operating conditions and circuit components for a cathode-follower circuit having an output impedance that will match a 500-ohm transmission line. **Procedure:** First, determine the approximate transconductance required.

$$\text{Required } g_m = \frac{1,000,000}{500} = 2000 \mu\text{mhos}$$

A survey of the tubes that have a transconductance in this order of magnitude shows that type 12AX7 is among the tubes to be considered. Referring to the characteristics given in the technical data section for one triode unit of high-mu twin triode 12AX7, we find that for a plate voltage of 250 volts and a bias of -2 volts, the transconductance is 1600

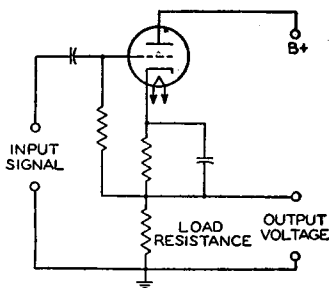

Fig. 32

micromhos, the plate resistance is 62500 ohms, the amplification factor is 100, and the plate current is 0.0012 ampere.

When these values are used in the expression for determining the cathode load resistance, we obtain

$$\text{Cathode } R_L = \frac{500 \times 62500}{62500 - 500 \times (100 + 1)} = 2600 \text{ ohms}$$

The voltage across this resistor for a plate current of 0.0012 ampere is  $2600 \times 0.0012 = 3.12$  volts. Because the required bias voltage is only  $-2$  volts, the circuit arrangement given in Fig. 30 is employed. The bias is furnished by a resistance that will have a voltage drop of 2 volts when it carries a current of 0.0012 ampere. The required bias resistance, therefore, is  $2/0.0012 = 1670$  ohms. If 60 cycles per second is the lowest frequency to be passed, 20 microfarads is a suitable value for the bypass capacitor. The B-supply, of course, is increased by the voltage drop across the cathode resistance which, in this example, is approximately 5 volts. The B-supply, therefore, is  $250 + 5 = 255$  volts.

Because it is desirable to eliminate, if possible, the bias resistor and bypass capacitor, it is worthwhile to try other tubes and other operating conditions to obtain a value of cathode load resistance which will also provide the required bias. If the triode section of twin diode—high- $\mu$  triode 6AT6 is operated under the conditions given in the technical data section with a plate voltage of 100 volts and a bias of  $-1$  volt, it will have an amplification factor of 70, a plate resistance of 54000 ohms, a transconductance of 1300 micromhos, and a plate current of 0.0008 ampere.

Then,

$$\text{Cathode } R_L = \frac{500 \times 54000}{54000 - 500 \times (70 + 1)} = 1460 \text{ ohms}$$

The bias voltage obtained across this resistance is  $1460 \times 0.0008 = 1.17$  volts. Since this value is for all practical purposes close enough to the required bias, no additional bias resistance will be required and the grid may be returned directly to ground. There is no need to adjust the B-supply voltage to make up for the drop in the cathode resistor. The voltage amplification (V.A.) for the cathode-follower circuit utilizing the triode section of type 6AT6 is

$$\text{V.A.} = \frac{70 \times 1460}{54000 + 1460 \times (70 + 1)} = 0.65$$

For applications in which the cathode follower is used to isolate two circuits—for example, when it is used between a circuit being tested and the input stage of an oscilloscope or a vacuum-tube voltmeter—voltage output and not impedance matching is the primary consideration. In such applications it is desirable to use a relatively high value of cathode load resistance, such as 50,000 ohms, in order to get the maximum voltage output. In order to obtain proper bias, a circuit such as that of Fig. 32 should be used. With a high value of cathode resistance, the voltage amplification will approximate unity.

### Corrective Filters

A corrective filter can be used to improve the frequency characteristic of an output stage using a beam power tube or a pentode when inverse feedback is not applicable. The filter consists of a resistor and a capacitor connected in series across the primary of the output transformer. Connected in this way, the filter is in parallel with the plate load impedance reflected from the voice-coil by the output transformer. The magnitude of this reflected impedance increases with increasing frequency in the middle and upper audio range. The impedance of the filter, however, decreases with increasing frequency. It follows that by use of the proper values for the resistance and the capacitance in the filter, the effective load impedance on the output tubes can be made practically constant for all frequencies in the middle and upper audio range. The result is an improvement in the frequency characteristic of the output stage.

The resistance to be used in the filter for a push-pull stage is 1.3 times the recommended plate-to-plate load resistance; or, for a single-tube stage, is 1.3 times the recommended plate load resistance. The capacitance in the filter should have a value such that the voltage gain of the output stage at a frequency of 1000 cycles or higher is equal to the voltage gain at 400 cycles.

A method of determining the proper value of capacitance for the filter is to make two measurements of the output voltage across the primary of the output transformer: first, when a 400-cycle sig-



nal is applied to the input, and second, when a 1000-cycle signal of the same voltage as the 400-cycle signal is applied to the input. The correct value of capacitance is the one which gives equal output voltages for the two signal inputs. In practice, this value is usually found to be in the order of 0.05 microfarad.

### Volume Expanders

A volume expander can be used in a phonograph amplifier to make more natural the reproduction of music which has a very large volume range. For instance, in the music of a symphony orchestra, the sound intensity of the loud passages is very much higher than that of the soft passages. When this music is recorded, it may not be feasible to make the ratio of maximum amplitude to minimum amplitude as large on the record as it is in the original music. The recording process may therefore be monitored so that the volume range of the original is compressed on the record. To compensate for this compression, a volume-expander amplifier has a variable gain which is greater for a high-amplitude signal than for a low-amplitude signal. The volume expander, therefore, amplifies loud passages more than soft passages.

A volume expander circuit is shown in Fig. 33. In this circuit, the gain of the 6L7 as an audio amplifier can be varied

grid of the 6J5, is amplified by the 6J5, and is rectified by the 6H6. The rectified voltage developed across  $R_8$ , the load resistor of the 6H6, is applied as a positive bias voltage to grid No. 3 of the 6L7. Then, when the amplitude of the signal input increases, the voltage across  $R_8$  increases, and the bias on grid No. 3 of the 6L7 is made less negative. Because this reduction in bias increases the gain of the 6L7, the gain of the amplifier increases with increase in signal amplitude and thus produces volume expansion of the signal. The voltage gain of the expander varies from 5 to 20.

Grid No. 1 of the 6L7 is a variable-mu grid and, therefore, will produce distortion if the input signal voltage is too large. For that reason, the signal input to the 6L7 should not exceed a peak value of 1 volt. The no-signal bias voltage on grid No. 3 is controlled by adjustment of contact P. This contact should be adjusted initially to give a no-signal plate current of 0.15 milliampere in the 6L7. No further adjustment of contact P is required if the same 6L7 is always used. If it is desired to delay volume expansion until the signal input reaches a certain amplitude, the delay voltage can be inserted as a negative bias on the 6H6 plates at the point marked X in the diagram. All terminal points on the power-supply voltage divider should be adequately bypassed.

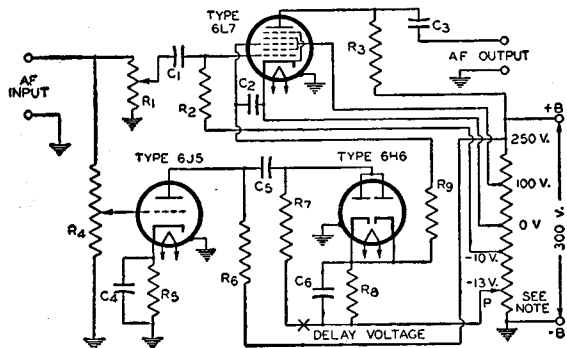

Fig. 33

- $C_1, C_3, C_5 = 0.1 \mu f$
- $C_2, C_4, C_6 = 0.5 \mu f$
- $R_1 = 1\text{-Megohm Potentiometer (Volume Control)}$
- $R_2 = 1\text{ Megohm}$
- $R_3, R_6 = 100,000\text{ ohms, } 1\text{ watt}$
- $R_4 = 1\text{-Megohm Potentiometer (Expansion Control)}$
- $R_5 = 10,000\text{ ohms, } 0.1\text{ watt}$
- $R_7 = 100,000\text{ ohms, } 0.1\text{ watt}$
- $R_8 = 250,000\text{ ohms, } 0.1\text{ watt}$
- $R_9 = 500,000\text{ ohms, } 0.1\text{ watt}$

by changing the bias on grid No. 3. When the bias on grid No. 3 is made less negative, the gain of the 6L7 increases. The signal to be amplified is applied to grid No. 1 of the 6L7 and is amplified by the 6L7. The signal is also applied to the

### Phase Inverters

A phase inverter is a circuit used to provide resistance coupling between the output of a single-tube stage and the input of a push-pull stage. The necessity for a phase inverter arises because the

signal-voltage inputs to the grids of a push-pull stage must be 180 degrees out of phase and approximately equal in amplitude with respect to each other. Thus, when the signal voltage input to a push-pull stage swings the grid of one tube in a positive direction, it should swing the grid of the other tube in a negative direction by a similar amount. With transformer coupling between stages, the out-of-phase input voltage to the push-pull stage is supplied by means of the center-tapped secondary. With resistance coupling, the out-of-phase input voltage is obtained by means of the inverter action of a tube.

Fig. 34 shows a push-pull power amplifier, resistance-coupled by means of a phase-inverter circuit to a single-stage triode  $T_1$ . Phase inversion in this circuit is provided by triode  $T_2$ . The output voltage of  $T_1$  is applied to the grid

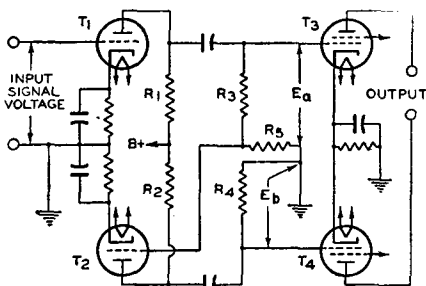

Fig. 34

of triode  $T_3$ . A portion of the output voltage of  $T_1$  is also applied through the resistors  $R_3$  and  $R_5$  to the grid of  $T_2$ . The output voltage of  $T_2$  is applied to the grid of triode  $T_4$ .

When the output voltage of  $T_1$  swings in the positive direction, the plate current of  $T_2$  increases. This action increases the voltage drop across the plate resistor  $R_2$  and swings the plate of  $T_2$  in the negative direction. Thus, when the output voltage of  $T_1$  swings positive, the output voltage of  $T_2$  swings negative and is, therefore, 180° out of phase with the output voltage of  $T_1$ .

In order to obtain equal voltages at  $E_a$  and  $E_b$ ,  $(R_3+R_5)/R_5$  should equal the voltage gain of  $T_2$ . Under the conditions where a twin-type tube or two tubes having the same characteristics are used at  $T_1$  and  $T_2$ ,  $R_4$  should be equal to

the sum of  $R_3$  and  $R_5$ . The ratio of  $R_3+R_5$  to  $R_5$  should be the same as the voltage gain ratio of  $T_2$  in order to apply the correct value of signal voltage to  $T_2$ . The value of  $R_5$  is, therefore, equal to  $R_4$  divided by the voltage gain of  $T_2$ ;  $R_3$  is equal to  $R_4$  minus  $R_5$ . Values of  $R_1$ ,  $R_2$ ,  $R_3$  plus  $R_5$ , and  $R_4$  may be taken from the chart in the RESISTANCE-COUPLED AMPLIFIER SECTION. In the practical application of this circuit, it is convenient to use a twin-triode tube combining  $T_1$  and  $T_2$ .

### Limiters

An amplifier may also be used as a limiter. One use of a limiter is in receivers designed for the reception of frequency-modulated signals. The limiter in FM receivers has the function of eliminating amplitude variations from the input to the detector. Because in an FM system amplitude variations are primarily the result of noise disturbances, the use of a limiter prevents such disturbances from being reproduced in the audio output. The limiter usually follows the last if stage so that it can minimize the effects of disturbances coming in on the rf carrier and those produced locally.

The limiter is essentially an if voltage amplifier designed for saturated operation. Saturated operation means that an increase in signal voltage above a certain value produces very little increase in plate current. A signal voltage which is never less than sufficient to cause saturation of the limiter, even on weak signals, is supplied to the limiter input by the preceding stages. Any change in amplitude, therefore, such as might be produced by noise voltage fluctuation, is not reproduced in the limiter output. The limiting action, of course, does not interfere with the reproduction of frequency variations.

Plate-current saturation of the limiter may be obtained by the use of grid-No.1-resistor-and-capacitor bias with plate and grid-No.2 voltages which are low compared with customary if-amplifier operating conditions.

As a result of these design features, the limiter is able to maintain its output voltage at a constant amplitude over a wide range of input-signal voltage varia-

tions. The output of the limiter is frequency-modulated if voltage, the mean frequency of which is that of the if amplifier. This voltage is impressed on the input of the detector.

The reception of FM signals without serious distortion requires that the response of the receiver be such that satisfactory amplification of the signal is provided over the entire range of frequency deviation from the mean frequency. Since the frequency at any instant depends on the modulation at that instant, it follows that excessive attenuation toward the edges of the band, in the rf or if stages, will cause distortion. In a high-fidelity receiver, therefore, the amplifiers must be capable of amplifying, for the maximum permissible frequency deviation of 75 kilocycles, a band 150 kilocycles wide. Suitable tubes for this purpose are the 6BA6 and 6BJ6.

### Television RF Amplifiers

All amplifier stages generate a certain amount of noise as a result of thermal agitation of electrons in resistors or other components, minute variations in the cathode emission of tubes (shot effect), and minute grid currents in the amplifier tubes. In a radio or television receiver, noise generated in the first amplifier stage is often the controlling factor in determining the over-all sensitivity of the receiver. The "front end" of a receiver, therefore, is designed with special attention to both gain and noise characteristics.

Tuner input circuits of vhf television receivers use either a triode or a pentode in the rf amplifier stage. Such stages are required to amplify signals ranging from 55 to 216 Mc and having a bandwidth of 4.5 Mc, although the tuner is usually aligned for a bandwidth of 6 Mc to assure complete coverage of the band. In the early rf tuners, pentodes rather than triodes were used because the grid-plate capacitance of triodes created stability problems. Since the development of the cascode-type circuit shown in Fig. 35, however, the stable operation previously obtained only with pentode amplifiers has been combined with the low-noise characteristics of triodes.

The rf amplifier stage shown in Fig. 35 uses a high-gain twin triode such as

the 6BQ7-A or 6BZ7. The relatively high transconductance of these tubes permits high gain and low equivalent noise resistance. These tubes also provide high input impedance which aids in obtaining high input-circuit gain over the vhf television broadcast range. The twin-triode circuit permits better isolation between the antenna circuit and the oscillator stage than a pentode amplifier circuit.

The gain of the rf amplifier stage is improved in the upper vhf range by use of the series inductance,  $L_s$ , between the plate of the first triode section and the cathode of the second triode section of the 6BQ7-A or 6BZ7. This inductance resonates in series with the total (tube plus stray) capacitance, designated  $C_T$ , between the cathode of the second triode

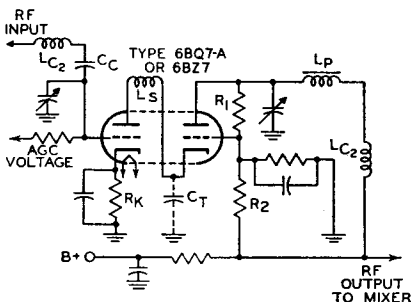

Fig. 35

section and ground. The value of  $L_s$  is chosen so that the resonance occurs above the upper end of the vhf broadcast range. The use of this series resonant circuit minimizes feedback of rf voltage from the plate of the first triode section to the input grid. In the lower vhf range, the effect of the series resonant circuit is negligible. This circuit has a sufficiently broad frequency response to permit the use of fixed components.

The direct coupling between the two triode sections of the 6BQ7-A or 6BZ7 causes the voltage between plate and cathode to increase when a bias voltage is applied to the first triode section, thereby extending the tube's cut-off characteristic. This extension minimizes cross-modulation when automatic gain control (agc) bias is applied to the

grid of the first triode section. For most effective gain control over a wide range of input levels, however, it is desirable to allow the bias of the second triode section also to vary somewhat with signal level. Consequently, the grid of the second triode section is connected to a tap on a dc voltage divider between the plate of the second triode section and a fixed voltage source, E. When the input signal is strong, the application of agc bias to the grid of the first triode section increases the total voltage drop across the tube and produces a higher positive potential on the direct-coupled cathode of the second triode section. The grid of the second triode section, however, is prevented from following the cathode potential completely because of the voltage-divider connection to the fixed-potential source. Therefore, the grid bias developed in the second triode section depends on the ratio between the voltage-divider connection and the plate potential of the input triode. The values of E, R<sub>1</sub>, and R<sub>2</sub> are chosen so that the stage has a suitable gain characteristic over a wide range of input-signal levels.

### Video Amplifiers

The video amplifier stage in a television receiver usually employs a pentode-type tube specially designed to amplify the wide band of frequencies contained in the video signal and, at the same time, to provide high gain per stage. Pentodes are more useful than triodes in such stages because they have high transconductance (to provide high gain) together with low input and output interelectrode capacitances (to permit the broadband requirements to be satisfied). An approximate "figure of merit" for a particular tube for this application can be determined from the ratio of its transconductance, g<sub>m</sub>, to the sum of its input and output capacitances, C<sub>in</sub> and C<sub>out</sub>, as follows:

$$\text{Figure of Merit} = \frac{g_m}{C_{in} + C_{out}}$$

Typical values for this figure are in the order of 500 x 10<sup>6</sup> or greater.

A typical video amplifier stage, such as that shown in Fig. 36, is connected between the second detector of the television receiver and the picture tube. The contrast control, R<sub>1</sub>, in this

circuit controls the gain of the video amplifier tube. The inductance, L<sub>2</sub>, in series with the load resistor, R<sub>L</sub>, maintains the plate load impedance at a relatively constant value with increasing

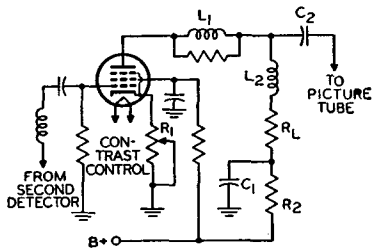

Fig. 36

frequency. The inductance L<sub>1</sub> isolates the output capacitance of the tube so that only stray capacitance is placed across the load. As a result, a higher-value load resistor is used to provide higher gain without affecting frequency response or phase relations. The decoupling circuit, C<sub>1</sub>R<sub>2</sub>, is used to improve the low-frequency response. Tubes used as video amplifiers include types 6CL6 and 12BY7, or the pentode sections of types 6AW8 and 6AN8.

The luminance amplifier in a color-television receiver is a conventional video amplifier having a bandwidth of approximately 3.5 Mc. In a color receiver, the portion of the output of the second detector which lies within the frequency

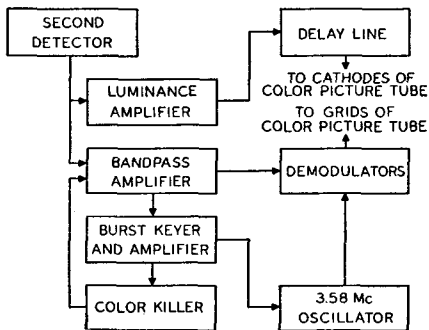

Fig. 37

band from approximately 2.4 to 4.5 Mc is fed to a bandpass amplifier, as shown in the block diagram in Fig. 37. The color synchronizing signal, or "burst," con-

tained in this signal may then be fed to a "burst-keyer" tube. At the same time, a delayed horizontal pulse may be applied to the keyer tube. The output of the keyer tube is applied to the burst amplifier tube and the signal is then fed to the 3.58-Mc oscillator and to the "color-killer" stage.

The color killer applies a bias voltage to the bandpass amplifier in the absence of burst so that the color section, or chrominance channel, of the receiver remains inoperative during black-and-white broadcasts. A threshold control varies the bias and controls the burst level at which the killer stage operates.

The output of the 3.58-Mc oscillator and the output of the bandpass amplifier are fed into phase and amplitude demodulator circuits. The output of each demodulator circuit is an electrical representation of a color-difference signal, *i.e.*, an actual color signal minus the black-and-white, or luminance, signal. The two color-difference signals are combined to produce the third color-difference signal; each of the three signals then represents one of the primary colors.

The three color-difference signals are usually applied to the grids of the three electron guns of the color picture tube, in which case the black-and-white signal from the luminance amplifier may be applied simultaneously to the cathodes. The chrominance and luminance signals then combine to produce the color picture. In the absence of transmitted color information, the chrominance channel is cut off by the color killer, as described above, and only the luminance signal is applied to the picture tube, producing a black-and-white picture.

### Television Sync Circuits

In addition to picture information, the composite video signal supplied to a television receiver contains information to assure that the picture produced on the receiver is synchronized with the picture being viewed by the camera or pickup tube. The "sync" pulses, which have a greater amplitude than the video signal, trigger the scanning generators of the receiver when the electron beam of the pickup tube ends each trace.

The sync pulses in the composite video signal may be separated from the video information in the output of the second or video detector by means of the triode circuit shown in Fig. 38. In this circuit, the time constant of the network  $R_1C_1$  is long with respect to the interval between pulses. During each pulse, the grid is driven positive and draws current, thereby charging capacitor  $C_1$ . Consequently, the grid develops a bias which is slightly greater than the cutoff voltage of the tube. Because plate current flows only during the sync-pulse period, only the amplified pulse appears in the output. This sync-separator stage

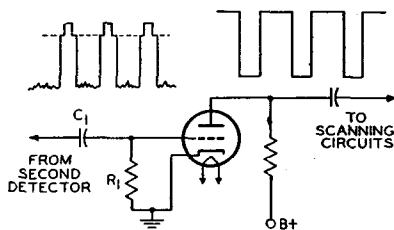

Fig. 38

discriminates against the video information. Because the bias developed on the grid is proportional to the strength of the incoming signal, the circuit also has the advantage of being relatively independent of signal fluctuations.

Because the electron beam scans the face of the picture tube at different rates in the vertical and horizontal directions, the receiver incorporates two different scanning generators. The repetition rate of the vertical generator is 60 cycles per second, and the rate of the horizontal generator is approximately 15,750 cycles per second. The composite video signal includes information which enables each generator to derive its correct triggering. One horizontal sync pulse is supplied at the end of each horizontal line scan. At the end of each frame, several pulses of longer duration than the horizontal sync pulses are supplied to actuate the vertical generator. The vertical information is separated from the horizontal information by differentiating and integrating circuits.

### Rectification

The rectifying action of a diode

finds important applications in supplying a receiver with dc power from an ac line and in supplying high dc voltage from a high-voltage pulse. A typical arrangement for converting ac to dc includes a rectifier tube, a filter, and a voltage divider. The rectifying action of the tube is explained briefly under *Diodes*, in the ELECTRONS, ELECTRODES, AND ELECTRON TUBE SECTION. High-voltage pulse rectification is described later under *Horizontal Output Circuits*.

The function of a filter is to smooth out the ripple of the tube output, as indicated in Fig. 39, and to increase rectifier efficiency. The action of the filter is explained in ELECTRON TUBE INSTALLATION SECTION under *Filters*. The voltage divider is used to cut down the output voltage to the values required by the plates and the other electrodes of the tubes in the receiver.

A half-wave rectifier and a full-wave rectifier circuit are shown in Fig. 40. In the half-wave circuit, current flows through the rectifier tube to the filter on every other half-cycle of the ac input voltage when the plate is positive with respect to the cathode. In the full-wave circuit, current flows to the filter on every half-cycle, through plate No. 1 on one half-cycle when plate No. 1 is positive with respect to the cathode, and through plate No. 2 on the next half-cycle when plate No. 2 is positive with respect to the cathode.

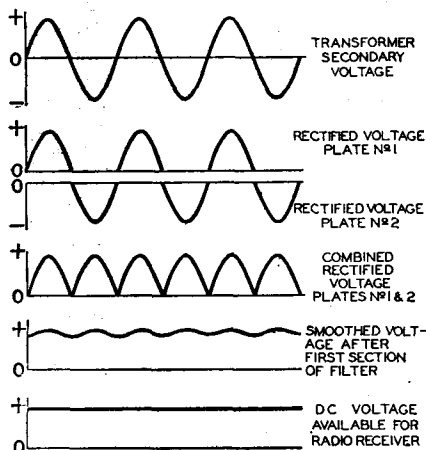

Fig. 39

Because the current flow to the filter is more uniform in the full-wave circuit than in the half-wave circuit, the output of the full-wave circuit requires less filtering. Rectifier operating information and circuits are given under each

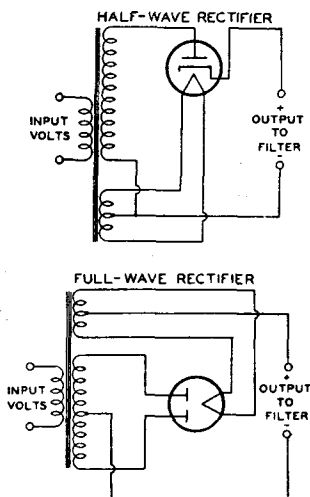

Fig. 40

rectifier tube type and in the **CIRCUIT SECTION**, respectively.

**Parallel operation** of rectifier tubes furnishes an output current greater than that obtainable with the use of one tube. For example, when two full-wave rectifier tubes are connected in parallel, the plates of each tube are connected together and each tube acts as a half-wave rectifier. The allowable voltage and load conditions per tube are the same as for full-wave service but the total load-handling capability of the complete rectifier is approximately doubled.

When mercury-vapor rectifier tubes are connected in parallel, a stabilizing resistor of 50 to 100 ohms should be connected in series with each plate lead in order that each tube will carry an equal share of the load. The value of the resistor to be used will depend on the amount of plate current that passes through the rectifier. Low plate current requires a high value; high plate current, a low value. When the plates of mercury-vapor rectifier tubes are connected in parallel, the corresponding filament leads should be similarly con-

ected. Otherwise, the tube drops will be considerably unbalanced and larger stabilizing resistors will be required.

Two or more vacuum rectifier tubes can also be connected in parallel to give correspondingly higher output current and, as a result of paralleling their internal resistances, give somewhat increased voltage output. With vacuum types, stabilizing resistors may or may not be necessary depending on the tube type and the circuit.

A voltage-doubler circuit of simple form is shown in Fig. 41. The circuit derives its name from the fact that its dc

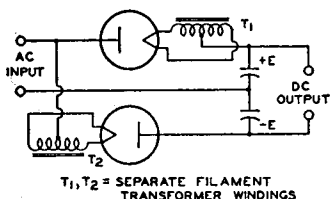

Fig. 41

voltage output can be as high as twice the peak value of ac input. Basically, a voltage doubler is a rectifier circuit arranged so that the output voltages of two half-wave rectifiers are in series.

The action of a voltage doubler can be described briefly as follows. On the positive half-cycle of the ac input, that is, when the upper side of the ac input line is positive with respect to the lower side, the upper diode passes current and feeds a positive charge into the upper capacitor. As positive charge accumulates on the upper plate of the capacitor, a positive voltage builds up across the capacitor. On the next half-cycle of the ac input, when the upper side of the line is negative with respect to the lower side, the lower diode passes current so that a negative voltage builds up across the lower capacitor.

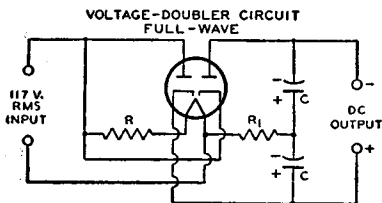

Fig. 42

R = HEATERS OF OTHER TUBES IN SERIES WITH VOLTAGE-DROPPING RESISTOR  
R<sub>1</sub> = PROTECTIVE RESISTOR

So long as no current is drawn at the output terminals from the capacitor, each capacitor can charge up to a voltage of magnitude E, the peak value of the ac input. It can be seen from the diagram that with a voltage of +E on one capacitor and -E on the other, the total voltage across the capacitors is 2E. Thus the voltage doubler supplies a no-load dc output voltage twice as large as the peak ac input voltage. When current is drawn at the output terminals by the load, the output voltage drops below 2E by an amount that depends on the magnitude of the load current and the capacitance of the capacitors. The arrangement shown in Fig. 41 is called a full-wave voltage doubler because each rectifier passes current to the load on each half of the ac input cycle.

Two rectifier types especially designed for use as voltage doublers are the 25Z6 and 117Z6-GT. These tubes combine two separate diodes in one tube. As voltage doublers, the tubes are used in "transformerless" receivers. In these receivers, the heaters of all tubes in the set are connected in series with a voltage-dropping resistor across the line. The connections for the heater supply and the voltage-doubling circuit are shown in Figs. 42 and 43.

With the full-wave voltage-doubler circuit in Fig. 42, it will be noted that the dc load circuit can not be connected to ground or to one side of the ac supply line. This circuit presents certain disadvantages when the heaters of all the tubes in the set are connected in series with a resistance across the ac line. Such a circuit arrangement may cause hum because of the high ac potential between the heaters and cathodes of the tubes.

The circuit in Fig. 43 overcomes this difficulty by making one side of the ac line common with the negative side

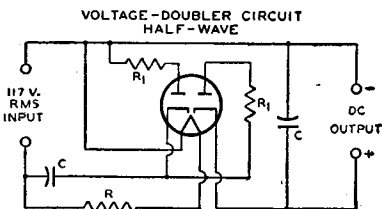

Fig. 43

of the dc load circuit. In this circuit, one half of the tube is used to charge a capacitor which, on the following half cycle, discharges in series with the line voltage through the other half of the tube. This

A diode-detector circuit is shown in Fig. 45. The action of this circuit when a modulated rf wave is applied is illustrated by Fig. 46. The rf voltage applied to the circuit is shown in light

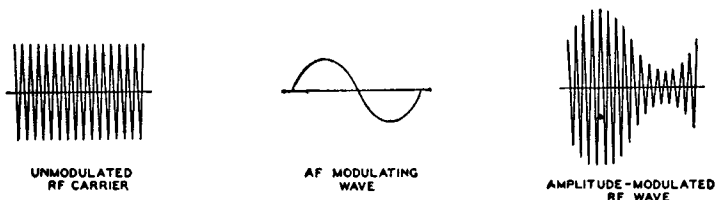

Fig. 44

circuit is called a half-wave voltage doubler because rectified current flows to the load only on alternate halves of the ac input cycle. The voltage regulation of this arrangement is somewhat poorer than that of the full-wave voltage doubler.

### Detection

When speech, music, or video information is transmitted from a radio or television station, the station radiates a radio-frequency (rf) wave which is of either of two general types. In one type, the wave is said to be amplitude modulated when its frequency remains constant and the amplitude is varied. In the other type, the wave is said to be frequency modulated when its amplitude remains essentially constant but its frequency is varied.

The function of the receiver is to reproduce the original modulating wave from the modulated rf wave. The receiver stage in which this function is performed is called the demodulator or detector stage.

### AM Detection

The effect of amplitude modulation on the waveform of the rf wave is shown in Fig. 44. There are three different basic circuits used for the detection of amplitude-modulated waves: the diode detector, the grid-bias detector, and the grid-resistor detector. These circuits are alike in that they eliminate, either partially or completely, alternate half-cycles of the rf wave. With alternate half-cycles removed, the audio variations of the other half-cycles can be amplified to drive headphones or a loudspeaker.

line; the output voltage across capacitor C is shown in heavy line.

Between points (a) and (b) on the first positive half-cycle of the applied rf voltage, capacitor C charges up to the peak value of the rf voltage. Then as the applied rf voltage falls away from its peak value, the capacitor holds the cathode at a potential more positive than the voltage applied to the anode. The capacitor thus temporarily cuts off current through the diode. While the diode current is cut off, the capacitor discharges from (b) to (c) through the diode load resistor R.

When the rf voltage on the anode rises high enough to exceed the potential at which the capacitor holds the cathode, current flows again and the capacitor charges up to the peak value of the second positive half-cycle at (d). In this

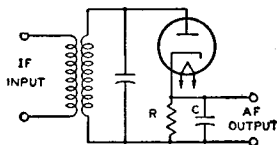

Fig. 45

way, the voltage across the capacitor follows the peak value of the applied rf voltage and reproduces the af modulation.

The curve for voltage across the capacitor, as drawn in Fig. 46, is somewhat jagged. However, this jaggedness, which represents an rf component in the voltage across the capacitor, is exaggerated in the drawing. In an actual circuit



the rf component of the voltage across the capacitor is negligible. Hence, when the voltage across the capacitor is amplified, the output of the amplifier reproduces the speech or music originating at the transmitting station.

Another way to describe the action of a diode detector is to consider the circuit as a half-wave rectifier. When the rf signal on the plate swings positive, the tube conducts and the rectified current flows through the load resistance  $R$ . Because the dc output voltage of a rectifier depends on the voltage of the ac input, the dc voltage across  $C$  varies in accordance with the amplitude of the rf carrier and thus reproduces the af signal. Capacitor  $C$  should be large enough to smooth out rf or if variations but should not be so large as to affect the audio variations. Two diodes can be connected in a circuit similar to a full-wave rectifier to give full-wave detection. However, in

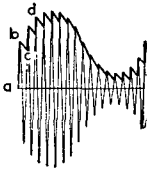

Fig. 46

practice, the advantages of this connection generally do not justify the extra circuit complication.

The diode method of detection produces less distortion than other methods because the dynamic characteristics of a diode can be made more linear than those of other detectors. The disadvantages of a diode are that it does not amplify the signal, and that it draws current from the input circuit and therefore reduces the selectivity of the input circuit. However, because the diode method of detection produces less distortion and because it permits the use of simple avc circuits without the necessity for an additional voltage supply, the diode method of detection is most widely used in broadcast receivers.

A typical diode-detector circuit using a twin-diode triode tube is shown in Fig. 47. Both diodes are connected together.  $R_1$  is the diode load resistor. A portion of the af voltage developed across this resistor is applied to the triode grid

through the volume control  $R_3$ . In a typical circuit, resistor  $R_1$  may be tapped so that five-sixths of the total af voltage across  $R_1$  is applied to the volume control. This tapped connection reduces the

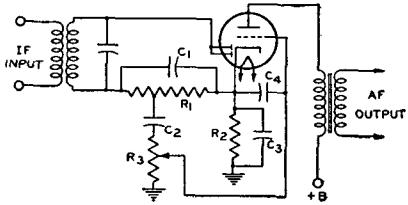

Fig. 47

af voltage output of the detector circuit slightly but it reduces audio distortion and improves the rf filtering.

DC bias for the triode section is provided by the cathode-bias resistor  $R_2$  and the audio bypass capacitor  $C_3$ . The function of capacitor  $C_2$  is to block the dc bias of the cathode from the grid. The function of capacitor  $C_4$  is to bypass any rf voltage on the grid to cathode. A twin-diode pentode may also be used in this circuit. With a pentode, the af output should be resistance-coupled rather than transformer-coupled.

Another diode-detector circuit, called a diode-biased circuit, is shown in Fig. 48. In this circuit, the triode grid is connected directly to a tap on the diode load resistor. When an rf signal voltage is applied to the diode, the dc voltage at the tap supplies bias to the triode grid. When the rf signal is modulated, the af voltage at the tap is applied to the grid and is amplified by the triode.

The advantage of the circuit shown in Fig. 48 over the self-biased arrange-

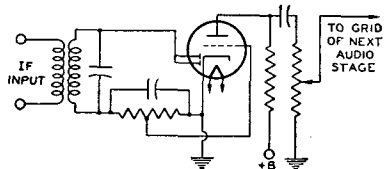

Fig. 48

ment shown in Fig. 47 is that the diode-biased circuit does not employ a capacitor between the grid and the diode load resistor, and consequently does not produce as much distortion of a signal having a high percentage of modulation.

However, there are restrictions on the use of the diode-biased circuit. Because the bias voltage on the triode depends on the average amplitude of the rf voltage applied to the diode, the average amplitude of the voltage applied to the diode should be constant for all values of signal strength at the antenna. Otherwise there will be different values of bias on the triode grid for different signal strengths and the triode will produce distortion. Because there is no bias applied to the diode-biased triode when no rf voltage is applied to the diode, sufficient resistance should be included in the plate circuit of the triode to limit its zero-bias plate current to a safe value.

These restrictions mean, in practice, that the receiver should have a separate-channel automatic-volume-control (avc) system. With such an avc system, the average amplitude of the signal voltage applied to the diode can be held within very close limits for all values of signal strength at the antenna.

The tube used in a diode-biased circuit should be one which operates at a fairly large value of bias voltage. The variations in bias voltage are then a small percentage of the total bias and hence produce small distortion. Tubes taking a fairly large bias voltage are types such as the 6BF6 or 6SR7 having a medium-mu triode. Tube types having a high-mu triode or a pentode should not be used in a diode-biased circuit.

A **grid-bias detector** circuit is shown in Fig. 49. In this circuit, the grid is biased almost to cutoff, *i.e.*, operated

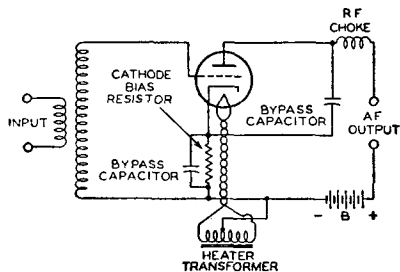

Fig. 49

so that the plate current with zero signal is practically zero. The bias voltage can be obtained from a cathode-bias resistor, a C-battery, or a bleeder tap. Because of the high negative bias, only the positive

half-cycles of the rf signal are amplified by the tube. The signal is, therefore, detected in the plate circuit. The advantages of this method of detection are that it amplifies the signal, besides detecting it, and that it does not draw current from the input circuit and therefore does not lower the selectivity of the input circuit.

The **grid-resistor-and-capacitor method**, illustrated by Fig. 50, is somewhat more sensitive than the grid-bias

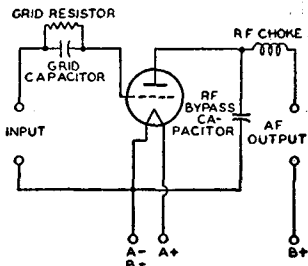

Fig. 50

method and gives its best results on weak signals. In this circuit, there is no negative dc bias voltage applied to the grid. Hence, on the positive half-cycles of the rf signal, current flows from grid to cathode. The grid and cathode thus act as a diode detector, with the grid resistor as the diode load resistor and the grid capacitor as the rf bypass capacitor. The voltage across the capacitor then reproduces the af modulation in the same manner as has been explained for the diode detector. This voltage appears between the grid and cathode and is therefore amplified in the plate circuit. The output voltage thus reproduces the original af signal.

In this detector circuit, the use of a high-resistance grid resistor increases selectivity and sensitivity. However, improved af response and stability are obtained with lower values of grid-circuit resistance. This detector circuit amplifies the signal, but draws current from the input circuit and therefore lowers the selectivity of the input circuit.

### FM Detection

The effect of **frequency modulation** on the waveform of the rf wave is shown in Fig. 51. In this type of transmission, the frequency of the rf wave deviates

from a mean value, at an af rate depending on the modulation, by an amount that is determined in the transmitter and is proportional to the amplitude of the af modulation signal.

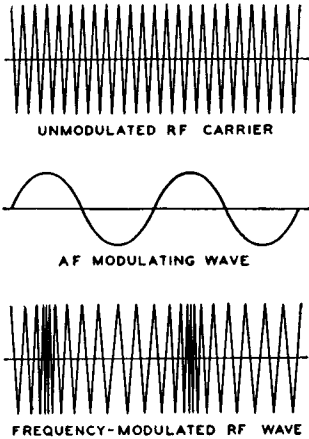

Fig. 51

For this type of modulation, a detector is required to discriminate between deviations above and below the mean frequency and to translate those deviations into a voltage whose amplitude varies at audio frequencies. Since the deviations occur at an audio frequency, the process is one of demodulation, and the degree of frequency deviation determines the amplitude of the demodulated (af) voltage.

A simple circuit for converting frequency variations to amplitude variations is a circuit which is tuned so that the mean radio frequency is on one slope of its resonance characteristic, as at A

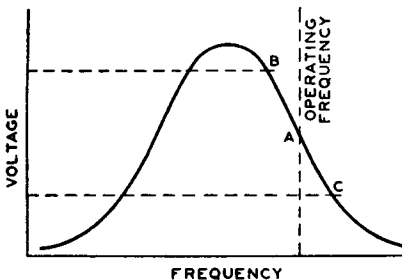

Fig. 52

of Fig. 52. With modulation, the frequency swings between B and C, and

the voltage developed across the circuit varies at the modulating rate. In order that no distortion will be introduced in this circuit, the frequency swing must be restricted to the portion of the slope which is effectively straight. Since this portion is very short, the voltage developed is low. Because of these limitations, this circuit is not commonly used but it serves to illustrate the principle.

The faults of the simple circuit are overcome in a push-pull arrangement, sometimes called a **discriminator circuit**, such as that shown in Fig. 53. Because of the phase relationships between the primary and each half of the secondary of the input transformer (each half of the secondary is connected in series with the primary through capacitor  $C_2$ ), the rf voltages applied to the diodes become unequal as the rf signal swings from the resonant frequency in each direction.

Since the swing occurs at audio frequencies (determined by the af modulation), the voltage developed across the diode load resistors,  $R_1$  and  $R_2$  connected in series, varies at audio frequencies. The

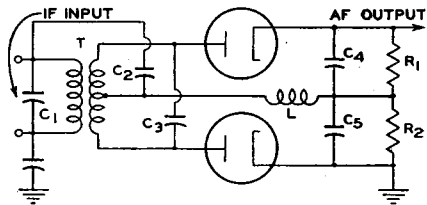

Fig. 53

output voltage depends on the difference in amplitude of the voltages developed across  $R_1$  and  $R_2$ . These voltages are equal and of opposite sign when the rf carrier is not modulated and the output is, therefore, zero. When modulation is applied, the output voltage varies as indicated in Fig. 54.

Because this type of FM detector is sensitive to amplitude variations in the rf carrier, a limiter stage is frequently used to remove most of the amplitude modulation from the carrier. (See *Limiters* under **Amplification**.)

Another form of detector for frequency-modulated waves is called a **ratio detector**. This FM detector, unlike the previous one which responds to a differ-

ence in voltage, responds only to changes in the ratio of the voltage across two diodes and is, therefore, insensitive to changes in the differences in the voltages

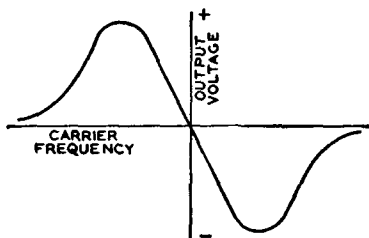

Fig. 54

due to amplitude modulation of the rf carrier.

The basic ratio detector is given in Fig. 55. The plate load for the final if amplifier stage is the parallel resonant circuit consisting of  $C_1$  and the primary transformer T. The tuning and coupling of the transformer is practically the same as in the previous circuit and, therefore, the rf voltages applied to the diodes depend upon how much the rf signal swings from the resonant frequency in each direction. At this point the similarity ends.

Diode 1,  $R_2$ , and diode 2 complete a series circuit fed by the secondary of the transformer T. The two diodes are connected in series so that they conduct on the same rf half-cycle. The rectified current through  $R_2$  causes a negative voltage to appear at the plate of diode 1. Because  $C_6$  is large, this negative voltage at the plate of diode 1 remains constant even at the lowest audio frequencies to be reproduced.

The rectified voltage across  $C_3$  is proportional to the voltage across diode

diodes differ according to the instantaneous frequency of the carrier, the voltages across  $C_3$  and  $C_4$  differ proportionately, the voltage across  $C_3$  being the larger of the two voltages at carrier frequencies below the intermediate frequency and the smaller at frequencies above the intermediate frequency.

These voltages across  $C_3$  and  $C_4$  are additive and their sum is fixed by the constant voltage across  $C_6$ . Therefore, while the ratio of these voltages varies at an audio rate, their sum is always constant. The voltage across  $C_4$  varies at an audio rate when a frequency-modulated rf carrier is applied to the ratio detector; this audio voltage is extracted and fed to the audio amplifier. For a complete circuit utilizing this type of detector, refer to the CIRCUIT SECTION.

### Automatic Volume or Gain Control

The chief purposes of automatic volume control (avc) or automatic gain control (agc) in a radio or television receiver are to prevent fluctuations in loudspeaker volume or picture brightness when the audio or video signal at the antenna is fading in and out.

An automatic volume control circuit regulates the receiver rf and if gain so that this gain is less for a strong signal than for a weak signal. In this way, when the signal strength at the antenna changes, the avc circuit reduces the resultant change in the voltage output of the last if stage and consequently reduces the change in the speaker output volume.

The avc circuit reduces the rf and if gain for a strong signal usually by increasing the negative bias of the rf, if,

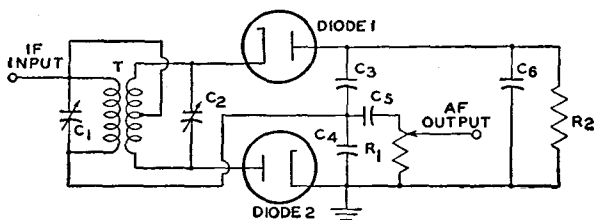

Fig. 55

1, and the rectified voltage across  $C_4$  is proportional to the voltage across diode 2. Since the voltages across the two

and frequency-mixer stages when the signal increases. A simple avc circuit is shown in Fig. 56. On each positive half-

cycle of the signal voltage, when the diode plate is positive with respect to the cathode, the diode passes current. Because of the flow of diode current through  $R_1$ , there is a voltage drop across  $R_1$  which makes the left end of  $R_1$  negative with respect to ground. This voltage drop across  $R_1$  is applied, through the

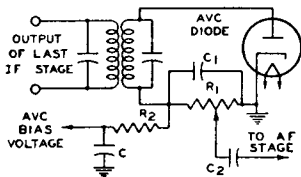

Fig. 56

filter  $R_2$  and  $C$ , as negative bias on the grids of the preceding stages. When the signal strength at the antenna increases, therefore, the signal applied to the avc diode increases, the voltage drop across  $R_1$  increases, the negative bias voltage applied to the rf and if stages increases, and the gain of the rf and if stages is decreased. Thus the increase in signal strength at the antenna does not produce as much increase in the output of the last if stage as it would produce without avc.

When the signal strength at the antenna decreases from a previous steady value, the avc circuit acts, of course, in the reverse direction, applying less negative bias, permitting the rf and if gain to increase, and thus reducing the decrease in the signal output of the last if stage. In this way, when the signal strength at the antenna changes, the avc circuit acts to reduce change in the output of the last if stage, and thus acts to reduce change in loudspeaker volume.

The filter,  $C$  and  $R_2$ , prevents the avc voltage from varying at audio frequency. The filter is necessary because the voltage drop across  $R_1$  varies with the modulation of the carrier being received. If avc voltage were taken directly from  $R_1$  without filtering, the audio variations in avc voltage would vary the receiver gain so as to smooth out the modulation of the carrier. To avoid this effect, the avc voltage is taken from the capacitor  $C$ . Because of the resistance  $R_2$  in series with  $C$ , the capacitor  $C$  can charge and discharge at only a compar-

tively slow rate. The avc voltage therefore cannot vary at frequencies as high as the audio range but can vary at frequencies high enough to compensate for most fading. Thus the filter permits the avc circuit to smooth out variations in signal due to fading, but prevents the circuit from smoothing out audio modulation.

It will be seen that an avc circuit and a diode-detector circuit are much alike. It is therefore convenient in a receiver to combine the detector and the avc diode in a single stage. Examples of how these functions are combined in receivers are shown in **CIRCUIT SECTION**.

In the circuit shown in Fig. 56, a certain amount of avc negative bias is applied to the preceding stages on a weak signal. Since it may be desirable to maintain the receiver rf and if gain at the maximum possible value for a weak signal, avc circuits are designed in some cases to apply no avc bias until the signal strength exceeds a certain value. These avc circuits are known as **delayed avc** or **davc** circuits.

A davc circuit is shown in Fig. 57. In this circuit, the diode section  $D_1$  of the 6H6 acts as detector and avc diode.  $R_1$  is the diode load resistor and  $R_2$  and  $C_2$  are the avc filter. Because the cathode of diode  $D_2$  is returned through a fixed supply of  $-3$  volts to the cathode of  $D_1$ , a

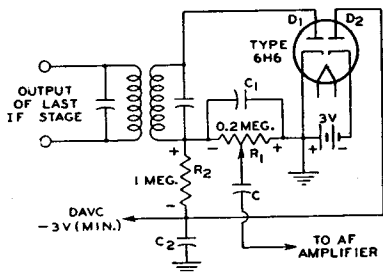

Fig. 57

dc current flows through  $R_1$  and  $R_2$  in series with  $D_2$ . The voltage drop caused by this current places the avc lead at approximately  $-3$  volts (less the negligible drop through  $D_2$ ). When the average amplitude of the rectified signal developed across  $R_1$  does not exceed 3 volts, the avc lead remains at  $-3$  volts. Hence, for signals not strong enough to develop

3 volts across  $R_1$ , the bias applied to the controlled tubes stays constant at a value giving high sensitivity.

However, when the average amplitude of rectified signal voltage across  $R_1$  exceeds 3 volts, the plate of diode  $D_2$  becomes more negative than the cathode of  $D_2$  and current flow in diode  $D_2$  ceases. The potential of the avc lead is then controlled by the voltage developed across  $R_1$ . Therefore, with further increase in signal strength, the avc circuit applies an increasing avc bias voltage to the controlled stages. In this way, the circuit regulates the receiver gain for strong signals, but permits the gain to stay constant at a maximum value for weak signals.

It can be seen in Fig. 57 that a portion of the -3 volts delay voltage is applied to the plate of the detector diode  $D_1$ , this portion being approximately equal to  $R_1/(R_1 + R_2)$  times -3 volts. Hence, with the circuit constants as shown, the detector plate is made negative with respect to its cathode by approximately one-half volt. However, this voltage does not interfere with detection because it is not large enough to prevent current flow in the tube.

**Automatic gain control (agc)** compensates for fluctuations in rf picture carrier amplitude. The peak carrier level rather than the average carrier level is controlled by the agc voltage because the peaks of the sync pulses are fixed when inserted on a fixed carrier level. The peak carrier level may be determined by measurement of the peaks of the sync pulses at the output of the video detector.

A conventional agc circuit, such as that shown in Fig. 58, consists of a diode detector circuit and an RC filter. The time constant of the detector circuit is made large enough to prevent the picture content from influencing the magnitude of the agc voltage. The output voltage (agc voltage) is equal to the peak value of the incoming signal.

The diode detector receives the incoming signal from the last if stage of the television receiver through the capacitor  $C_1$ . The resistor  $R_1$  provides the load for the diode. The diode conducts only when its plate is driven positive with respect to its cathode. Electrons

then flow from the cathode to the plate and thence into capacitor  $C_1$ , where the negative charge is stored. Because of the low impedance offered by the diode during conduction,  $C_1$  charges up to the value of the peak applied voltage.

During the negative excursion of the signal, the diode does not conduct, and  $C_1$  discharges through resistor  $R_1$ . Because of the large time constant of  $R_1C_1$ , however, only a small percentage of the voltage across  $C_1$  is lost during the interval between horizontal sync pulses. During succeeding positive cycles, the incoming signal must overcome the negative charge stored in  $C_1$  before the diode conducts, and plate current flows only at the peak of each positive cycle. The voltage across  $C_1$ , therefore, is determined by the level of the peaks of the positive cycles, or the sync pulses.

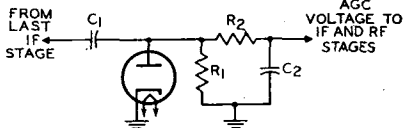

Fig. 58

The negative voltage developed across resistor  $R_1$  by the sync pulses is filtered by resistor  $R_2$  and capacitor  $C_2$  to remove the 15,750-cycle ripple of the horizontal sync pulse. The dc output is then fed to the if and rf amplifiers as an agc voltage.

This agc system may be expanded to include amplification of the agc signal before detection of the peak level, or amplification of the dc output, or both. A direct-coupled amplifier must be used for amplification of the dc signal. The addition of amplification makes the system more sensitive to changes in carrier level.

A "keyed" agc system such as that shown in Fig. 59 is used to eliminate flutter and to improve noise immunity in weak signal areas. This system provides more rapid action than the conventional agc circuits because the filter circuit can employ lower capacitance and resistance values.

In the keyed agc system, the negative output of the video detector is fed directly to the grid No.1 of the first video amplifier. The positive output of the video amplifier is, in turn, fed di-

rectly to the grid No.1 of the keyed agc amplifier. The video stage increases the gain of the agc system and, in addition, provides noise clipping. The plate voltage for the agc amplifier is a positive pulse obtained from a small winding on the horizontal output transformer which is in phase with the horizontal sync pulse obtained from the video amplifier. The polarity of this pulse is such that the plate of the agc amplifier tube is positive during the retrace time. The tube is biased so that current flows only when the grid No.1 and the plate are driven positive simultaneously. The amount of current flow depends on the grid-No.1 potential during the pulse. These pulses are smoothed out in the RC network in the plate circuit ( $R_1C_1$ ). Because the dc

potential of this electrode is less positive than the target, electrons flowing to the target are repelled by the electrostatic field of the electrode, and do not

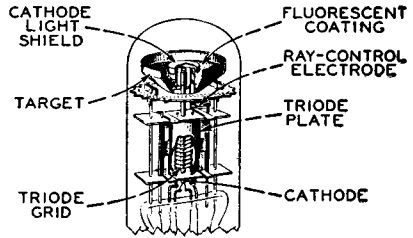

Fig. 60

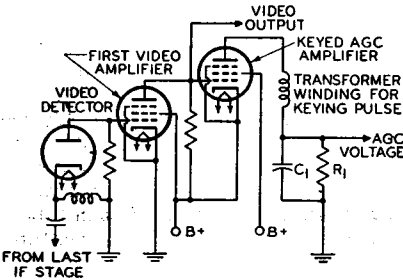

Fig. 59

voltage developed across  $R_1$  is negative, it is suitable for application to the grids of the rf and if tubes as an agc voltage.

### Tuning Indication With Electron-Ray Tubes

Electron-ray tubes are designed to indicate visually by means of a fluorescent target the effects of a change in controlling voltage. One application of them is as tuning indicators in radio receivers. Types such as the 6U5, 6E5, and the 6AB5/6N5 contain two main parts: (1) a triode which operates as a dc amplifier and (2) an electron-ray indicator which is located in the bulb as shown in Fig. 60. The target is operated at a positive voltage and, therefore, attracts electrons from the cathode. When the electrons strike the target they produce a glow on the fluorescent coating of the target. Under these conditions, the target appears as a ring of light.

A ray-control electrode is mounted between the cathode and target. When

reach that portion of the target behind the electrode. Because the target does not glow where it is shielded from electrons, the control electrode casts a shadow on the glowing target. The extent of this shadow varies from approximately  $100^\circ$  of the target when the control electrode is much more negative than the target to  $0^\circ$  when the control electrode is at approximately the same potential as the target.

In the application of the electron-ray tube, the potential of the control electrode is determined by the voltage on the grid of the triode section, as can be seen in Fig. 61. The flow of the triode plate current through resistor  $R$  produces a voltage drop which determines the potential of the control electrode. When the voltage of the triode grid changes in the positive direction, plate current increases, the potential of the control electrode goes down because of the increased drop across  $R$ , and the shadow angle widens. When the potential of the triode grid changes in the negative direction, the shadow angle narrows.

Another type of indicator tube is

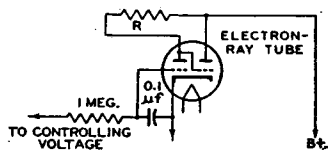

Fig. 61

the 6AF6-G. This tube contains only an indicator unit but employs two ray-control electrodes mounted on opposite sides of the cathode and connected to indi-

vidual base pins. It employs an external dc amplifier. (See Fig. 62.) Thus, two symmetrically opposite shadow angles may be obtained by connecting the two ray-control electrodes together; or, two unlike patterns may be obtained by individual connection of each ray-control electrode to its respective amplifier.

In radio receivers, avc voltage is applied to the grid of the dc amplifier. Because avc voltage is at maximum when the set is tuned to give maximum response to a station, the shadow angle is at minimum when the receiver is tuned to resonance with the desired station.

The choice between electron-ray tubes depends on the avc characteristic of the receiver. The 6E5 contains a sharp-cutoff triode which closes the shadow angle on a comparatively low value of avc voltage. The 6AB5/6N5

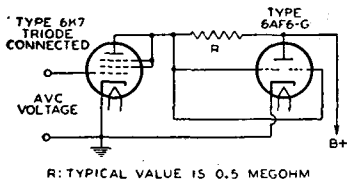

Fig. 62

and 6U5 each have a remote-cutoff triode which closes the shadow on a larger value of avc voltage than the 6E5. The 6AF6-G may be used in conjunction with dc amplifier tubes having either remote- or sharp-cutoff characteristics.

### Oscillation

As an oscillator, an electron tube can be employed to generate a continuously alternating voltage. In present-day radio broadcast receivers, this application is limited practically to superheterodyne receivers for supplying the heterodyning frequency. Several circuits (represented in Figs. 63 and 64) may be utilized, but they all depend on feeding more energy from the plate circuit to the grid circuit than is required to equal the power loss in the grid circuit. Feedback may be produced by electrostatic or electromagnetic coupling between the grid and plate circuits. When sufficient energy is fed back to more than compensate for the loss in the grid circuit, the

tube will oscillate. The action consists of regular surges of power between the plate and the grid circuit at a frequency dependent on the circuit constants of

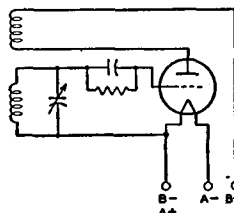

Fig. 63

inductance and capacitance. By proper choice of these values, the frequency may be adjusted over a very wide range.

### Multivibrators

Relaxation oscillators, which are widely used in present-day electronic equipment, are used to produce non-sinusoidal waveshapes such as rectangular and sawtooth pulses. Probably the most common relaxation oscillator is the multivibrator, which may be considered as a two-stage resistance-coupled amplifier in which the output of each tube is coupled into the input of the other tube.

Fig. 65 is a basic multivibrator circuit of the free-running type. In this circuit, oscillations are maintained by the alternate shifting of conduction from one tube to the other. The cycle usually starts with one tube,  $V_1$ , at zero bias, and the other,  $V_2$ , at cutoff or beyond. At this point, the capacitor  $C_1$  is charged sufficiently to cut off  $V_2$ .  $C_1$  then begins to discharge through the resistor  $R_2$ , and the voltage on the grid of  $V_2$  rises until  $V_2$  begins to conduct. The voltage on the

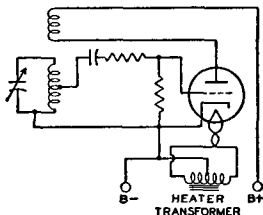

Fig. 64

plate of  $V_2$  then decreases, causing  $V_1$  to conduct less and less. At the same time, the plate voltage of  $V_1$  begins to rise, causing  $V_2$  to conduct still more heavily.



Because of the amplification, this cumulative effect builds up extremely fast, and conduction switches from  $V_1$  to  $V_2$  within a few microseconds, depending on the circuit components.

In this circuit, therefore, conduction switches from  $V_1$  to  $V_2$  over the interval during which  $C_1$  discharges from the voltage across  $R_4$  to the cutoff voltage for  $V_2$ . The actual transfer of conduction does not occur until cutoff is reached. Conduction switches back to  $V_1$  through a similar process to complete the cycle. The plate waveform is essentially rectangular in shape, and may be adjusted as to symmetry, frequency, and amplitude by proper choice of circuit constants, tubes, and voltages.

Although this type of multivibrator is free-running, it may be triggered by pulses of a given amplitude and frequency

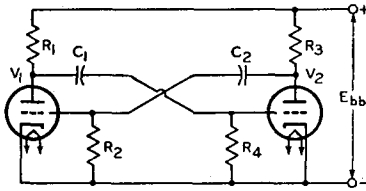

Fig. 65

to provide a frequency-stabilized output. Multivibrator circuits may also be designed so that they are not free-running, but must be triggered externally to shift conduction from one tube to the other. Depending on the type of circuit, conduction may shift back to the first tube after a given time interval, or the second tube may continue conducting until another trigger signal is applied.

### Synchroguide Circuits

The "synchroguide" is a controlled type of oscillator used in television receivers to generate and control the synchronized sawtooth voltage necessary for adequate line- or horizontal-frequency scanning. A simplified synchroguide circuit is shown in Fig. 66. This circuit provides stable, noise-free control of a blocking oscillator which generates a horizontal-frequency signal. It permits comparison of the received sync pulses and the generated sawtooth voltages so that properly locked-in horizontal scanning results.

The triode  $V_2$  in Fig. 66 is a conventional blocking oscillator which enables a sawtooth voltage to be developed

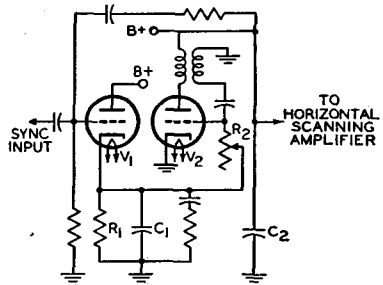

Fig. 66

across the capacitor  $C_2$ . A portion of this sawtooth is fed back to the grid of the control tube,  $V_1$ . The positive sync pulses are also applied to the grid of  $V_1$ . The waveforms shown in Fig. 67 illustrate the sawtooth and sync pulses (A and B) and their proper "in-sync" combination (C). The sync pulse occurs partly during the portion of the sawtooth voltage in which the triode  $V_1$  draws current. Any shift in sync pulse as it is superimposed on the sawtooth, therefore, will affect the amount of conduction of the control tube. A change in control-tube conduction ultimately affects the bias on the oscillator-tube grid by changing the voltage to which the capacitor  $C_1$  in the cathode circuit may charge. An increase in the positive bias increases the frequency of oscillation.

For example, waveform D in Fig. 67 illustrates a condition in which the sawtooth voltage is advanced in phase with respect to the sync-pulses. The

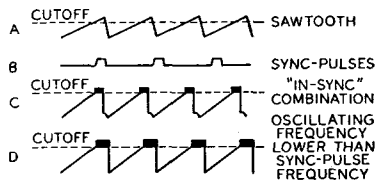

Fig. 67

widening of the pulse which occurs at the corner of the sawtooth waveform allows the control tube to conduct more current and, consequently, allows the capacitor  $C_1$  to charge to a higher volt-

age. This increased reference voltage is, in turn, fed to the oscillator ( $V_2$ ) grid through the voltage divider ( $R_1R_2$ ) and increases the positive bias. The increased bias then speeds up the frequency of oscillations until proper synchronization results.

### Deflection Circuits

#### Vertical Output Circuits

A modified multivibrator in which the vertical output tube is part of the oscillator circuit is used in the vertical deflection stage of many television receivers. This stage supplies the deflection energy required for vertical deflection of the picture-tube beam. A simplified combined vertical-oscillator-output stage is shown in Fig. 68. Waveshapes at critical points of the circuit are included

damping, and lengthened retrace time. However, the grid voltage is made sufficiently negative during retrace to keep the tube close to cutoff, as described below.

The frequency, and the relative deviation of the positive and negative portions of each cycle, are dependent on the values of resistors  $R_1$  and  $R_3$  and the RC combination  $R_3C_2$ , as explained previously in the section on multivibrators. The desired trapezoidal waveshape at the grid of  $V_2$  is created by capacitor  $C_1$  and resistor  $R_2$ . If  $R_2$  were equal to zero,  $C_1$  would cause the grid-voltage waveshape to take the form shown in Fig. 69(a). When  $R_2$  is sufficiently large,  $C_1$  does not discharge completely when  $V_1$  conducts. When  $V_1$  is cut off, therefore, the voltage on the grid of  $V_2$  immedi-

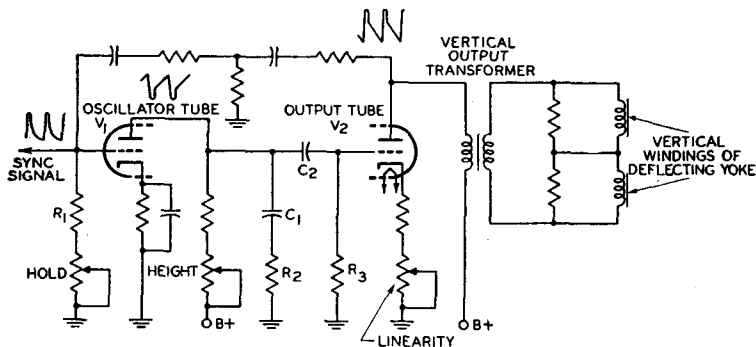

Fig. 68

to illustrate the development of the desired current through the vertical output transformer and deflecting yoke.

The current waveform through the deflecting yoke and output transformer should be a sawtooth to provide the desired deflection. The grid and plate voltage waveforms of the output tube could also be sawtooth except for the effect of the inductive components in the yoke and transformer. The effect of these inductive components must be taken into consideration, however, particularly during retrace. The fast rate of current change during retrace time (which is approximately 1/15 as long as trace time) causes a high-voltage pulse at the plate which could give a trapezoidal waveshape to the plate voltage and cause increased plate current, excess

conduction, and thereby prevents over-damping. The resulting waveshape is shown in Fig. 69(b). The negative-going pulse of the grid-voltage waveshape prevents the high plate pulse from causing excess

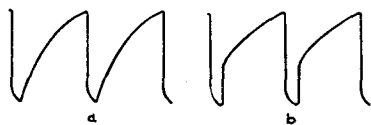

Fig. 69

conduction, and thereby prevents over-damping.

This vertical deflection stage utilizes twin-triode tubes such as the 12BH7 and 6CM7. The 6CM7 is particularly suitable for this application because it

incorporates dissimilar units to provide for the different operating requirements of the oscillator and output sections.

### Horizontal Output Circuits

Fig. 70 shows a typical horizontal-output-and-deflection circuit used in television receivers. In addition to supplying the deflection energy required for horizontal deflection of the picture-tube beam, this circuit provides the high dc voltage required for the ultor of the picture tube and the "boosted" B voltage for other portions of the receiver. The horizontal-output tube is usually a beam power tube such as the 6BQ6-GTB/6CU6 or 6CD6-GA.

In this circuit, a sawtooth voltage from the horizontal-oscillator tube is applied to the grid No.1 of the horizontal-output tube. When this voltage rises above the cutoff point of the output tube, the tube conducts a sawtooth of plate current which is fed through the autotransformer to the horizontal-deflecting yoke. At the end of the horizontal-scanning cycle, which lasts for 63.4 microseconds, the sawtooth voltage on the grid suddenly cuts off the output tube. This sudden change sets up an oscillation of about 50 to 70 Kc in the output circuit, which may be considered as an inductor shunted by the stray capacitance of the circuit. During the first half of this oscillation, a positive voltage appears across the transformer. In the second half of the cycle, the voltage swings below the plate supply voltage, and the damper diode conducts, damping out the oscillation. At the same time, the current through the deflecting yoke reverses and reaches its negative peak. As the damper-diode current decays exponentially to zero, the output tube begins to conduct again. The yoke current, therefore, is composed of current resulting from damper-diode conduction followed by output-tube conduction.

When the output tube is suddenly cut off, the high-voltage pulse produced by shock excitation of the load circuit is increased by means of an extra winding on the transformer. This high-voltage pulse charges a high-voltage capacitor through the high-voltage rectifier. The output of this circuit is the dc high-voltage supply for the picture tube. The

high-voltage rectifier also obtains its filament power through a separate winding on the horizontal-output transformer.

Current flowing through the damper diode charges the "boost" capacitor through the damper portion of the transformer winding. The polarity of the charge on the capacitor is such that the voltage at the low end of the winding is increased above the plate supply voltage, or B+. This higher voltage or "boost" is used for the output-tube plate supply, and may also supply the deflection oscillators and the vertical-output circuit provided the current drain is not excessive.

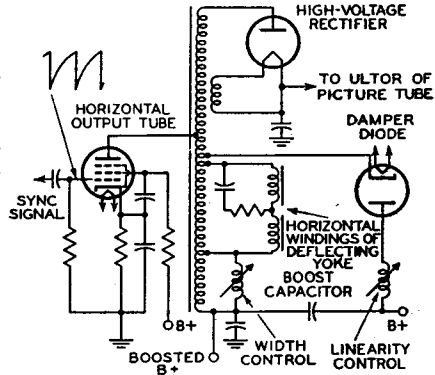

Fig 70

### Frequency Conversion

Frequency conversion is used in superheterodyne receivers to change the frequency of the rf signal to an intermediate frequency. To perform this change in frequency, a frequency-converting device consisting of an oscillator and a frequency mixer is employed. In such a device, shown diagrammatically in Fig. 71, two voltages of different frequency, the rf signal voltage and the voltage generated by the oscillator, are applied to the input of the frequency mixer. These voltages beat, or heterodyne, within the mixer tube to produce a plate current having, in addition to the frequencies of the input voltages, numerous sum and difference frequencies.

The output circuit of the mixer stage is provided with a tuned circuit which is adjusted to select only one beat frequency, *i.e.*, the frequency equal to the difference between the signal fre-

quency and the oscillator frequency. The selected output frequency is known as the intermediate frequency, or *if*. The output frequency of the mixer tube is kept constant for all values of signal frequency by tuning the oscillator to the proper frequency.

Important advantages gained in a receiver by the conversion of signal frequency to a fixed intermediate frequency are high selectivity with few tuning stages and a high, as well as stable, overall gain for the receiver.

Several methods of frequency conversion for superheterodyne receivers

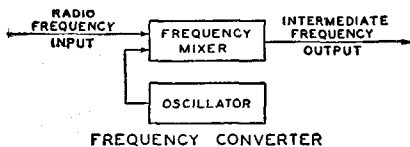

Fig. 71

are of interest. These methods are alike in that they employ a frequency-mixer tube in which plate current is varied at a combination frequency of the signal frequency and the oscillator frequency. These variations in plate current produce across the tuned plate load a voltage of the desired intermediate frequency. The methods differ in the types of tubes employed and in the means of supply input voltages to the mixer tube.

A method widely used before the availability of tubes especially designed for frequency-conversion service and currently used in many FM, television, and standard broadcast receivers, employs as mixer tube either a triode, a tetrode, or a pentode, in which oscillator voltage and signal voltage are applied to the same grid. In this method, coupling between the oscillator and mixer circuits is obtained by means of inductance or capacitance.

A second method employs a tube having an oscillator and frequency mixer combined in the same envelope. In one form of such a tube, coupling between the two units is obtained by means of the electron stream within the tube. Because five grids are used, the tube is called a pentagrid converter.

Grids No. 1 and No. 2 and the cathode are connected to an external circuit to act as a triode oscillator. Grid No. 1

is the grid of the oscillator and grid No. 2 is the anode. These and the cathode can be considered as a composite cathode which supplies to the rest of the tube an electron stream that varies at the oscillator frequency.

This varying electron stream is further controlled by the rf signal voltage on grid No. 4. Thus, the variations in plate current are due to the combination of the oscillator and the signal frequencies. The purpose of grids No. 3 and No. 5, which are connected together within the tube, is to accelerate the electron stream and to shield grid No. 4 electrostatically from the other electrodes.

Pentagrid-converter tubes of this design are good frequency-converting devices at medium frequencies. However, their performance is better at the lower frequencies because the output of the oscillator drops off as the frequency is raised and because certain undesirable effects produced by interaction between oscillator and signal sections of the tube increase with frequency.

To minimize these effects, several of the pentagrid-converter tubes are designed so that no electrode functions alone as the oscillator anode. In these tubes, grid No. 1 functions as the oscillator grid, and grid No. 2 is connected within the tube to the screen grid (grid No. 4). The combined two grids, Nos. 2 and 4, shield the signal grid (grid No. 3) and act as the composite anode of the oscillator triode. Grid No. 5 acts as the suppressor grid.

Converter tubes of this type are designed so that the space charge around the cathode is unaffected by electrons from the signal grid. Furthermore, the electrostatic field of the signal grid also has little effect on the space charge. The result is that rf voltage on the signal grid produces little effect on the cathode current. There is, therefore, little detuning of the oscillator by avc bias because changes in avc bias produce little change in oscillator transconductance or in the input capacitance of grid No. 1.

Examples of the pentagrid converters discussed in the preceding paragraph are the single-ended types 1R5 and 6BE6. A schematic diagram illustrating the use of the 6BE6 with self-excitation is given in Fig. 72; the 6BE6 may also

be used with separate excitation. A complete circuit is shown in the **CIRCUIT SECTION**.

Another method of frequency conversion utilizes a separate oscillator having its grid connected to the No. 1 grid of a mixer hexode. The cathode, triode

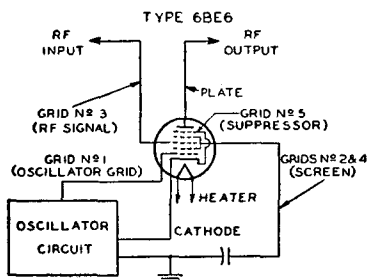

Fig. 72

grid, and triode plate form the oscillator unit of the tube. The cathode, hexode mixer grid (grid No. 1), hexode screen grids (grids Nos. 2 and 4), hexode signal grid (grid No. 3), and hexode plate constitute the mixer unit. The internal shields are connected to the shell of the tube and act as a suppressor grid for the hexode unit.

The action of this tube in converting a radio-frequency signal to an intermediate frequency depends on (1) the generation of a local frequency by the triode unit, (2) the transferring of this frequency to the hexode grid No. 1, and (3) the mixing in the hexode unit of this frequency with that of the rf signal applied to the hexode grid No. 3. The tube is not critical to changes in oscillator-plate voltage or signal-grid bias and, therefore, finds important use in all-wave receivers to minimize frequency-shift effects at the higher frequencies.

A further method of frequency conversion employs a tube called a pentagrid mixer. This type has two independent control grids and is used with a separate oscillator tube. RF signal voltage is applied to one of the control grids and oscillator voltage is applied to the other. It follows, therefore, that the variations in plate current are due to the combination of the oscillator and signal frequencies.

The tube contains a heater-cathode, five grids, and a plate. Grids Nos. 1 and

3 are control grids. The rf signal voltage is applied to grid No. 1. This grid has a remote-cutoff characteristic and is suited for control by avc bias voltage. The oscillator voltage is applied to grid No. 3. This grid has a sharp-cutoff characteristic and produces a comparatively large effect on plate current for a small amount of oscillator voltage. Grids Nos. 2 and 4 are connected together within the tube. They accelerate the electron stream and shield grid No. 3 electrostatically from the other electrodes. Grid No. 5, connected within the tube to the cathode, functions similarly to the suppressor grid in a pentode.

In the converter or mixer stage of a television receiver, stable oscillator operation is most readily obtained when separate tubes or tube sections are used for the oscillator and mixer functions. A typical television mixer-oscillator circuit is shown in Fig. 73. In such circuits, the oscillator voltage is applied to the mixer grid by inductive coupling, capacitive coupling, or a combination of the two.

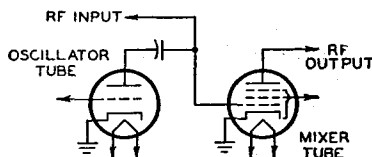

Fig. 73

Tubes containing electrically independent oscillator and mixer units in the same envelope, such as the 6U8 and 6X8, are designed especially for this application.

### Automatic Frequency Control

An automatic frequency control (afc) circuit provides a means of correcting automatically the intermediate frequency of a superheterodyne receiver when, for any reason, it drifts from the frequency to which the if stages are tuned. This correction is made by adjusting the frequency of the oscillator. Such a circuit will automatically compensate for slight changes in rf carrier or oscillator frequency as well as for inaccurate manual or push-button tuning.

An afc system requires two sections: a frequency detector and a variable reactance. The detector section may be

essentially the same as the FM detector illustrated in Fig. 53 and discussed under *Detection*. In the afc system, however, the output is a dc control voltage, the magnitude of which is proportional to the amount of frequency shift. This dc control voltage is used to control the grid bias of an electron tube which comprises the variable reactance section (Fig. 74).

The plate current of the reactance tube is shunted across the oscillator tank

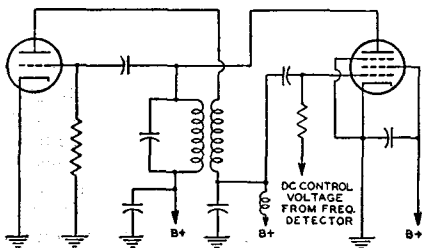

Fig. 74

circuit. Because the plate current and plate voltage of the reactance tube are almost  $90^\circ$  out of phase, the control tube affects the tank circuit in the same manner as a reactance. The grid bias of the tube determines the magnitude of the effective reactance and, consequently, a control of this grid bias can be used to control the oscillator frequency.

Automatic frequency control is also used in television receivers to keep the horizontal oscillator in step with the horizontal-scanning frequency (15,750 cps) at the transmitter. A widely used horizontal afc circuit is shown in Fig. 75. This circuit, which is often referred to as a **balanced-phase-detector** or **phase-discriminator** circuit, is usually employed to control the frequency of a multivibrator-type horizontal-oscillator circuit. The 6AL5 detector supplies a dc control voltage to the grid of the horizontal-oscillator tube which counteracts changes in its operating frequency. The magnitude and polarity of the control voltages are determined by phase relationships in the afc circuit at a given moment.

The horizontal sync pulses obtained from the sync-separator circuit are fed

through a single-triode phase-inverter or phase-splitter circuit to the two diode units of the 6AL5. Because of the action of the phase-inverter circuit, the signals applied to the two diode units are equal in amplitude but  $180^\circ$  degrees out of phase. A reference sawtooth voltage obtained from the horizontal output circuit is also applied simultaneously to both units. Any change in the oscillator frequency alters the phase relationship between the reference sawtooth and the incoming horizontal sync pulses, causing one diode unit of the 6AL5 to conduct more heavily than the other, and thus producing a correction signal. The system remains balanced at all times, therefore, because momentary changes in oscillator frequency are instantaneously corrected by the action of the control voltage.

The diode units of the 6AL5 are biased so that conduction takes place only during the tips of the sync pulses. The relative position of the sync pulses on the retrace portion of the sawtooth waveform at any given instant determines which diode unit conducts more heavily, and thereby establishes the magnitude and polarity of the control voltage. The network between the diode

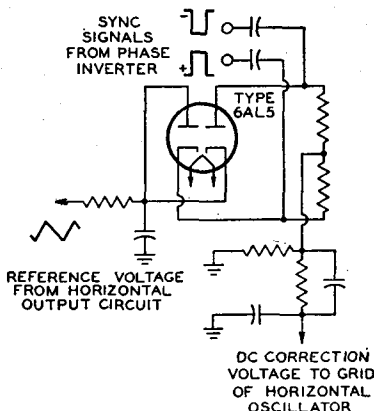

Fig. 75

units and the grid of the horizontal-oscillator tube is essentially a low-pass filter which prevents the horizontal sync pulses from affecting the horizontal-oscillator performance.

# Electron Tube Installation

The installation of electron tubes requires care if high-quality performance is to be obtained from the associated circuits. Installation suggestions and precautions which are generally common to all types of tubes are covered in this section. Careful observance of these suggestions will do much to help the experimenter and electronic technician obtain the full performance capabilities of radio tubes and circuits. Additional pertinent information is given under each tube type and in the **CIRCUIT SECTION**.

## Filament and Heater Power Supply

The design of electron tubes allows for some variation in the voltage and current supplied to the filament or heater, but most satisfactory results are obtained from operation at the rated values. When the voltage is low, the temperature of the cathode is below normal, with the result that electron emission is limited. The limited emission may cause unsatisfactory operation and reduced tube life. On the other hand, high cathode voltage may cause rapid evaporation of cathode material and shorten tube life.

To insure proper tube operation, it is important that the filament or heater voltage be checked at the socket terminals by means of a high-resistance voltmeter while the equipment is in operation. In the case of series operation of heaters or filaments, correct adjustment can be checked by means of an ammeter in the heater or filament circuit.

The filament or heater voltage supply may be a direct-current source (a battery or a dc power line) or an alternating-current power line, depending on the type of service and type of tube. Frequently, a resistor (either variable or fixed) is used with a dc supply to permit compensation for battery voltage variations or to adjust the tube voltage at the socket terminals to the correct value. Ordinarily, a step-down transformer is used with an ac supply to provide the proper filament or heater voltage. Receivers intended for operation on both dc and ac power lines have the heaters connected in series with a suit-

able resistor and supplied directly from the power line.

**DC filament or heater operation** should be considered on the basis of the source of power. In the case of the battery supply for the 1.4-volt filament tubes, it is unnecessary to use a voltage-dropping resistor in series with the filament and a single dry-cell; the filaments of these tubes are designed to operate satisfactorily over the range of voltage variations that normally occur during the life of a dry-cell. Likewise, no series resistor is required when the 1.25-volt filament subminiatures are operated from a single 1.5-volt flashlight-type dry-cell, when the 2-volt filament type tubes are operated from a single storage cell, or when the 6.3-volt series are operated from a 6-volt storage battery.

In the case of dry-battery supply for 2-volt filament tubes, a variable resistor in series with the filament and the battery is required to compensate for battery variations. Turning the set on and off by means of the rheostat is advised to prevent over-voltage conditions after an off-period because the voltage of dry-cells rises during off-periods.

In the case of storage-battery supply, air-cell-battery supply, or dc power supply, a non-adjustable resistor of suitable value may be used. It is well to check initial operating conditions, and thus the resistor value, by means of a voltmeter or ammeter.

The filament or heater resistor required when filaments and/or heaters are operated in parallel can be determined easily by a simple formula derived from Ohm's law.

$$\text{Required resistance (ohms)} = \frac{\text{supply volts} - \text{rated volts of tube type}}{\text{total rated filament current (amperes)}}$$

Thus, if a receiver using two IT4's, one IR5, one IU5, and one 3V4 is to be operated from a storage battery, the series resistor is equal to 2 volts (the voltage from a single storage cell) minus 1.4 volts (voltage rating for these tubes) divided by 0.3 ampere (the sum of  $4 \times 0.05$  ampere +  $1 \times 0.1$  ampere), *i.e.*, approximately 2 ohms. Since this resis-

tor should be variable to allow adjustment for battery depreciation, it is advisable to obtain the next larger commercial size, although any value between 2 and 3 ohms will be quite satisfactory.

Where much power is dissipated in the resistor, the wattage rating should be sufficiently large to prevent overheating. The power dissipation in watts is equal to the voltage drop in the resistor multiplied by the total filament current in amperes. Thus, for the example above,  $0.6 \times 0.3 = 0.18$  watt. In this case, the value is so small that any commercial rheostat with suitable resistance will be adequate.

For the case where the heaters and/or filaments of several tubes are operated in series, the resistor value is calculated by the following formula, also derived from Ohm's law.

$$\text{Required resistance (ohms)} = \frac{\text{supply volts} - \text{total rated volts of tubes}}{\text{rated amperes of tubes}}$$

Thus, if a receiver having one 6SA7, one 6SK7, one 6SF7, one 25L6-GT, and one 25Z6-GT is to be operated from a 117-volt power line, the series resistor is equal to 117 volts (the supply voltage) minus 68.9 volts (the sum of  $3 \times 6.3$  volts +  $2 \times 25$  volts) divided by 0.3 ampere (current rating of these tubes), i.e., approximately 160 ohms. The wattage dissipation in the resistor will be 117 volts minus 68.9 volts times 0.3 ampere, or approximately 14.4 watts. A resistor having a wattage rating in excess of this value should be chosen.

When the series-heater connection is used in ac/dc receivers, it is usually advisable to arrange the heaters in the circuit so that the tubes most sensitive to hum disturbances are at or near the ground potential of the circuit. This arrangement reduces the amount of ac voltage between the heaters and cathodes of these tubes and minimizes the

hum output of the receiver. The order of heater connection, by tube function, from chassis to the rectifier-cathode side of the ac line is shown in Fig. 76.

**AC filament or heater operation** should be considered on the basis of either a parallel or a series arrangement of filaments and/or heaters. In the case of the parallel arrangement, a step-down transformer is employed. Precautions should be taken to see that the line voltage is the same as that for which the primary of the transformer is designed. The line voltage may be determined by measurement with an ac voltmeter (0-150 volts).

If the line voltage measures in excess of that for which the transformer is designed, a resistor should be placed in series with the primary to reduce the line voltage to the rated value of the transformer primary. Unless this is done, the excess input voltage will cause proportionally excessive voltage to be applied to the tubes. Any electron tube may be damaged or made inoperative by excessive operating voltages.

If the line voltage is consistently below that for which the primary of the transformer is designed, it may be necessary to install a booster transformer between the ac outlet and the transformer primary. Before such a transformer is installed, the ac line fluctuations should be very carefully noted. Some radio sets are equipped with a line-voltage switch which permits adjustment of the power transformer primary to the line voltage. When this switch is properly adjusted, the series-resistor or booster-transformer method of controlling line voltage is seldom required.

In the case of the series arrangements of filaments and/or heaters, a voltage-dropping resistance in series with the heaters and the supply line is usually required. This resistance should be of such value that, for normal line voltage,

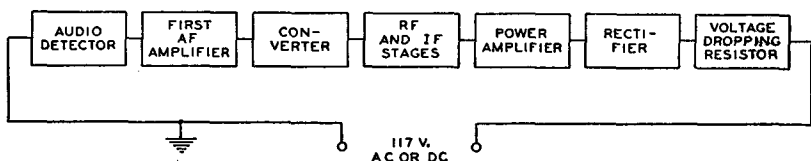

Fig. 76



tubes will operate at their rated heater or filament current. The method for calculating the resistor value is given above.

When the filaments of battery-type tubes are connected in series, the total filament current is the sum of the current due to the filament supply and the plate and grid-No.2 currents (cathode current) returning to B(-) through the tube filaments. Consequently, in a series filament string it is necessary to add shunt resistors across each filament section to bypass this cathode current in order to maintain the filament voltage at its rated value.

### Heater-to-Cathode Connection

The cathodes of heater-type tubes, when operated from ac, should be connected to the mid-tap on the heater supply winding, to the mid-tap of a 50-ohm (approximate) resistor shunted across the winding, or to one end of the heater supply winding depending on circuit requirements. If none of these methods is used, it is important to keep the heater-cathode voltage within the ratings given in the TUBE TYPES SECTION.

Hum from ac-operated heater tubes used in high-gain audio amplifiers may frequently be reduced to a negligible value by employing a 15- to 40-volt bias between the heater and cathode elements of the tubes. The bias should be connected so that the tube heater is positive with respect to its cathode. Such bias can be obtained from the regular plate-supply rectifier of the amplifier.

If a large resistor is used between heater and cathode, it should be bypassed by a suitable capacitor or objectionable hum may develop. The hum is due to the fact that even a minute pulsating leakage current flowing between the heater and cathode will develop a small voltage across any resistance in the circuit. This hum voltage is amplified by succeeding stages.

### Plate Voltage Supply

The plate voltage for electron tubes is obtained from batteries, rectifiers, direct-current power lines, and small local generators. The maximum plate-voltage value for any tube type should not be exceeded if most satisfactory performance is to be obtained. Plate volt-

age should not be applied to a tube unless the corresponding recommended voltage is also supplied to the grid.

It is recommended that the primary circuit of the power transformer be fused to protect the rectifier tube(s), the power transformer, filter capacitor, and chokes in case a rectifier tube fails.

### Grid Voltage Supply

The recommended grid voltages for different operating conditions have been carefully determined to give the most satisfactory performance. Grid voltage may be obtained from a fixed source such as a separate C-battery or a tap on the voltage divider of the high-voltage dc supply, from the voltage drop across a resistor in the cathode circuit, or from the voltage drop across a resistor in the grid circuit. The first method is called "fixed bias"; the second is called "cathode bias" or "self bias"; the third is called "grid-resistor bias" and is sometimes incorrectly referred to in receiving-tube practice as "zero-bias operation."

In any case, the object is to make the grid negative with respect to the cathode by the specified voltage. When a C-battery is used, the negative terminal is connected to the grid return and the positive terminal is connected to the negative filament socket terminal, or to the cathode terminal if the tube is of the heater-cathode type. If the filament is supplied with alternating current, this connection is usually made to the center-tap of a low resistance (20-50 ohms) shunted across the filament terminals. This method reduces hum disturbances caused by the ac supply. If bias voltages are obtained from the voltage divider of a high-voltage dc supply, the grid return is connected to a more negative tap than the cathode.

The **cathode-biasing** method utilizes the voltage drop produced by the cathode current flowing through a resistor connected between the cathode and the negative terminal of the B-supply. (See Fig. 77.) The cathode current is, of course, equal to the plate current in the case of a triode, or to the sum of the plate and grid-No.2 currents in the case of a tetrode, pentode, or beam power tube. Because the voltage drop along the resistance is increasingly nega-

tive with respect to the cathode, the required negative grid-bias voltage can be obtained by connecting the grid return to the negative end of the resistance.

The value of the resistance for cathode-biasing a single tube can be determined from the following formula:

$$\text{Resistance (ohms)} = \frac{\text{desired grid-bias voltage} \times 1000}{\text{rated cathode current in milliamperes}}$$

Thus, the resistance required to produce 9 volts bias for a triode which operates at 3 milliamperes plate current is  $9 \times 1000/3 = 3000$  ohms. If the cathode current of more than one tube passes through

change appreciably with plate current. When such a tube having a separate suppressor-grid connection is used as an rf amplifier, these changes may be minimized by leaving a certain portion of the cathode-bias resistor unbypassed. In order to minimize feedback when this method is used, the external grid-No.1-to-plate (wiring) capacitances should be kept to a minimum, the grid No.2 should be bypassed to ac ground, and the grid No.3 should be connected to ac ground.

The use of a cathode resistor to obtain bias voltage is not recommended for amplifiers in which there is appreciable shift of electrode currents with the

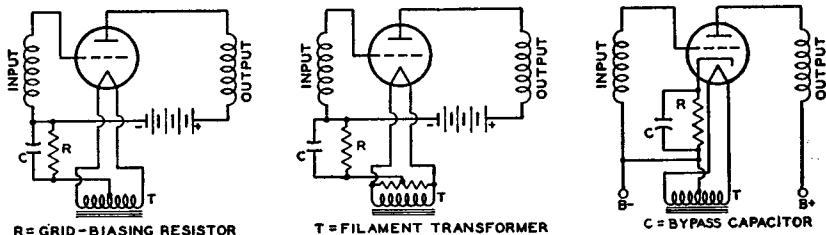

Fig. 77

the resistor, or if the tube or tubes employ more than three electrodes, the total current determines the size of the resistor.

**Bypassing** of the cathode-bias resistor depends on circuit-design requirements. In rf circuits the cathode resistor usually is bypassed. In af circuits the use of an unbypassed resistor will reduce distortion by introducing degeneration into the circuit. However, the use of an unbypassed resistor decreases gain and power sensitivity. When bypassing is used, it is important that the bypass capacitor be sufficiently large to have negligible reactance at the lowest frequency to be amplified.

In the case of power-output tubes having high transconductance such as the beam power tubes, it may be necessary to shunt the bias resistor with a small mica capacitor (approximately  $0.001\mu\text{f}$ ) in order to prevent oscillations. The usual af bypass may or may not be used, depending on whether or not degeneration is desired. In tubes having high values of transconductance, such as the 6BA6, 6CB6, and 6AC7, input capacitance and input conductance

application of a signal. In such amplifiers, a separate fixed supply is recommended.

The **grid-resistor biasing** method is also a self-bias method because it utilizes the voltage drop across the grid resistor produced by small amounts of grid current flowing in the grid-cathode circuit. This current is due to (1) an electromotive potential difference between the materials comprising the grid and cathode and (2) grid rectification when the grid is driven positive. A large value of resistance is required in order to limit this current to a very small value and to avoid undesirable loading effects on the preceding stage.

Examples of this method of bias are given in circuits 18-1 and 18-4 in the **CIRCUIT SECTION**. In both of these circuits, the audio amplifier type 1U5 or 12AV6 has a 10-megohm resistor between the grid and the negative filament or cathode to furnish the required bias which is usually less than 1 volt. This method of biasing is used principally in the early voltage amplifier stages (usually employing high- $\mu$  triodes) of audio amplifier circuits, where the tube dissi-

pation will not be excessive under zero-signal conditions.

A grid resistor is also used in many oscillator circuits for obtaining the required bias. In these circuits, the grid voltage is relatively constant and its magnitude is usually in the order of 5 volts or more. Consequently, the bias voltage is obtained only through grid rectification. A relatively low value of resistor, 0.1 megohm or less, is used. Oscillator circuits employing this method of bias are given in circuits 18-1 and 18-4 in the CIRCUIT SECTION.

**Grid-bias variation** for the rf and if amplifier stages is a convenient and frequently used method for controlling receiver volume. The variable voltage supplied to the grid may be obtained: (1) from a variable cathode resistor as shown in Figs. 78 and 79; (2) from a

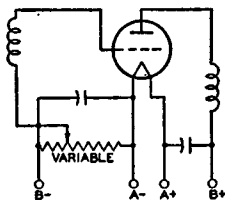

Fig. 78

bleeder circuit by means of a potentiometer as shown in Fig. 80; or (3) from a bleeder circuit in which the bleeder current is varied by a tube used for automatic volume control. The latter circuit is shown in Fig. 56.

In all cases it is important that the control be arranged so that at no time

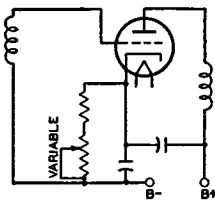

Fig. 79

will the bias be less than the recommended minimum grid-bias voltage for the particular tubes used. This requirement can be met by providing a fixed stop on the potentiometer, by connecting a fixed resistance in series with the variable resistance, or by connecting a fixed

cathode resistance in series with the variable resistance used for regulation. Where receiver gain is controlled by grid-bias variation, it is advisable to have the control voltages extend over a wide range in order to minimize cross-modulation and modulation-distortion.

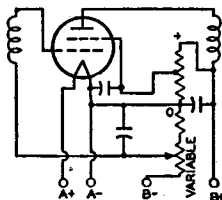

Fig. 80

A remote-cutoff type of tube should, therefore, be used in the controlled stages.

In most tubes employing a unipotential cathode, a positive grid current begins to flow when the grid is slightly negative and increases rapidly as the grid is made more positive, as shown in Fig. 81. The value of grid voltage at which positive grid current starts to flow is generally referred to as **contact potential**. Contact potential is caused by

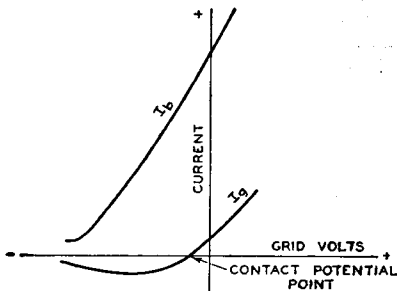

Fig. 81

the initial velocity of emission of electrons from the cathode and an electrothermal effect due to the differences in temperature and in material composition of the grid and the cathode.

The value of the contact-potential voltage may be as high as  $1\frac{1}{2}$  volts. If the operating bias of the tube is less than the contact potential, it is found that two effects are present. Direct current flows in the grid circuit, and the dynamic input resistance of the tube may be relatively low. It is generally desir-

able to supply the tube with a value of bias sufficiently high so that the tube is not operating within the contact-potential region. When a tube must be operated within this region, care should be taken to avoid undesirable effects in the grid circuit due to grid current or low input resistance.

### Screen-Grid Voltage Supply

The positive voltage for the screen grid (grid No.2) of screen-grid tubes may be obtained from a tap on a voltage divider, from a potentiometer, or from a series resistor connected to a high-voltage source, depending on the particular tube type and its application. The screen-grid voltage for tetrodes should be obtained from a voltage divider or a potentiometer rather than through a series resistor from a high-voltage source because of the characteristic screen-grid current variations of tetrodes. Fig. 82 shows a tetrode with its screen-grid voltage obtained from a potentiometer.

When pentodes or beam power tubes are operated under conditions where a large shift of plate and screen-grid currents does not take place with the application of the signal, the screen-grid voltage may be obtained through a series resistor from a high-voltage source. This method of supply is possible because of

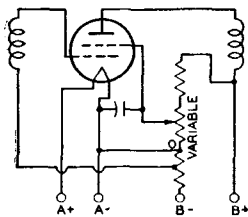

Fig. 82

the high uniformity of the screen-grid current characteristic in pentodes and beam power tubes. Because the screen-grid voltage rises with increase in bias and resulting decrease in screen-grid current, the cutoff characteristic of a pentode is extended by this method of supply.

This method is sometimes used to increase the range of signals which can be handled by a pentode. When used in resistance-coupled amplifier circuits employing pentodes in combination with

the cathode-biasing method, it minimizes the need for circuit adjustments. Fig. 83 shows a pentode with its screen-grid voltage supplied through a series resistor.

When power pentodes and beam power tubes are operated under conditions such that there is a large change in plate and screen-grid currents with the application of signal, the series-resistor method of obtaining screen-grid voltage should not be used. A change in screen-grid current appears as a change

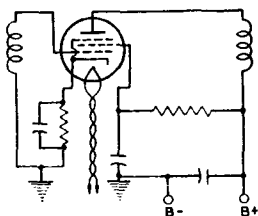

Fig. 83

in the voltage drop across the series resistor in the screen-grid circuit; the result is a change in the power output and an increase in distortion. The screen-grid voltage should be obtained from a point in the plate-voltage-supply filter system having the correct voltage, or from a separate source.

It is important to note that the plate voltage of tetrodes, pentodes, and beam power tubes should be applied before or simultaneously with the screen-grid voltage. Otherwise, with voltage on the screen grid only, the screen-grid current may rise high enough to cause excessive screen-grid dissipation.

**Screen-grid voltage variation** for the rf amplifier stages has sometimes been used for volume control in older-type receivers. Reduced screen-grid voltage lowers the transconductance of the tube and results in reduced gain per stage. The voltage variation is obtained by means of a potentiometer shunted across the screen-grid voltage supply. (See Fig. 82.) When the screen-grid voltage is varied, it must never exceed the rating of the tube. This requirement can be met by providing a fixed stop on the potentiometer.

### Shielding

In high-frequency stages having

high gain, the output circuit of each stage must be shielded from the input circuit of that stage. Each high-frequency stage also must be shielded from the other high-frequency stages. Unless shielding is employed, undesired feedback may occur and may produce many harmful effects on receiver performance.

To prevent this feedback, it is a desirable practice to shield separately each unit of the high-frequency stages. For instance, in a superheterodyne receiver, each if and rf coil may be mounted in a separate shield can. Baffle plates may be mounted on the ganged tuning capacitor to shield each section of the capacitor from the other section. The oscillator coil may be especially well shielded by being mounted under the chassis.

The shielding precautions required in a receiver depend on the design of the receiver and the layout of the parts. In all receivers having high-gain high-frequency stages, it is necessary to shield separately each tube in high-frequency stages. When metal tubes, and in particular the single-ended types, are used, complete shielding of each tube is provided by the metal shell which is grounded through its grounding pin as the socket terminal. The grounding connection should be short and sturdy. Many modern tubes of glass construction have internal shields, usually connected to the cathode; where present, these shields are indicated in the socket diagram.

### Dress of Circuit Leads

At high frequencies such as are encountered in FM and television receivers, lead dress, that is, the location and arrangement of the leads used for connections in the receiver, is very important. Because even a short lead provides a large impedance at high frequencies, it is necessary to keep all high-frequency leads as short as possible. This precaution is especially important for ground connections and for all connections to bypass capacitors and high-frequency filter capacitors. The ground connections of plate and screen-grid bypass capacitors of each tube should be kept short and made directly to cathode ground.

Particular care should be taken

with the lead dress of the input and output circuits of high-frequency stages so that the possibility of stray coupling is minimized. Unshielded leads connected to shielded components should be dressed close to the chassis. As the frequency increases, the need for careful lead dress becomes increasingly important.

In high-gain audio amplifiers, these same precautions should be taken to minimize the possibility of self-oscillation.

### Filters

Feedback effects also are caused in radio or television receivers by coupling between stages through common voltage-supply circuits. Filters find an important use in minimizing such effects. They should be placed in voltage-supply leads to each tube in order to return the signal current through a low-impedance path direct to the tube cathode rather than by way of the voltage-supply circuit. Fig. 84 illustrates several forms of filter circuits. Capacitor C forms the

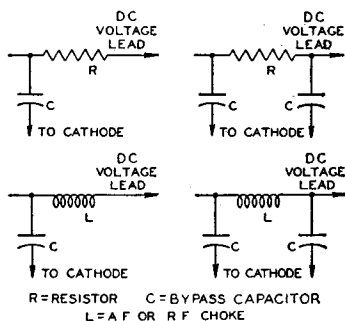

Fig. 84

low-impedance path, while the choke or resistor assists in diverting the signal through the capacitor by offering a high impedance to the power-supply circuit.

The choice between a resistor and a choke depends chiefly upon the permissible dc voltage drop through the filter. In circuits where the current is small (a few milliamperes), resistors are practical; where the current is large or regulation important, chokes are more suitable.

The minimum practical size of the capacitors may be estimated in most cases by the following rule: The impedance of the capacitor at the lowest fre-

quency amplified should not be more than one-fifth of the impedance of the filter choke or resistor at that frequency. Better results will be obtained in special cases if the ratio is not more than one-tenth.

Radio-frequency circuits, particularly at high frequencies, require high-quality capacitors. Mica or ceramic capacitors are preferable. Where stage shields are employed, filters should be placed within the shield.

Another important application of filters is to smooth the output of a rectifier tube. See *Rectification*. A smoothing

down is to be avoided. When the input-choke method is used, the available dc output voltage will be somewhat lower than with the input-capacitor method for a given ac plate voltage. However, improved regulation together with lower peak current will be obtained.

Mercury-vapor and gas-filled rectifier tubes occasionally produce a form of local interference in radio receivers through direct radiation or through the power line. This interference is generally identified in the receiver as a broadly tunable 120-cycle buzz (100 cycles for 50-cycle supply line, etc.). It is usually

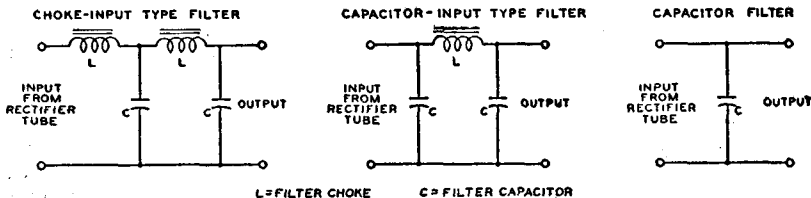

Fig. 85

filter usually consists of capacitors and iron-core chokes. In any filter-design problem, the load impedance must be considered as an integral part of the filter because the load is an important factor in filter performance. Smoothing effect is obtained from the chokes because they are in series with the load and offer a high impedance to the ripple voltage. Smoothing effect is obtained from the capacitors because they are in parallel with the load and store energy on the voltage peaks; this energy is released on the voltage dips and serves to maintain the voltage at the load substantially constant. Smoothing filters are classified as choke-input or capacitor-input according to whether a choke or capacitor is placed next to the rectifier tube. See Fig. 85.

The **CIRCUIT SECTION** gives a number of examples of rectifier circuits with recommended filter constants.

If an input capacitor is used, consideration must be given to the instantaneous peak value of the ac input voltage. This peak value is about 1.4 times the rms value as measured by an ac voltmeter. Filter capacitors, therefore, especially the input capacitor, should have a rating high enough to withstand the instantaneous peak value if break-

caused by the formation of a steep wave front when plate current within the tube begins to flow on the positive half of each cycle of the ac supply voltage.

There are several ways of eliminating this type of interference. One is to shield the tube. Another is to insert an rf choke having an inductance of one millihenry or more between each plate and transformer winding and to connect high-voltage, rf bypass capacitors between the outside ends of the transformer winding and the center tap. (See Fig. 86.) The rf chokes should be placed within the shielding of the tube. The rf bypass

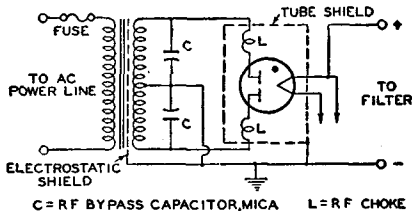

Fig. 86

capacitors should have a voltage rating high enough to withstand the peak voltage of each half of the secondary, which is approximately 1.4 times the rms value.

Transformers having electrostatic shielding between primary and second-

ary are not likely to transmit rf disturbances to the line. Often the interference may be eliminated simply by making the plate leads of the rectifier extremely short. In general, the particular method of interference elimination must be selected by experiment for each installation.

### Output-Coupling Devices

An output-coupling device is used in the plate circuit of a power output tube to keep the comparatively high dc plate current from the winding of an electromagnetic speaker and, also, to transfer power efficiently from the output stage to a loudspeaker of either the electromagnetic or dynamic type.

Output-coupling devices are of two types, (1) choke-capacitor and (2) transformer. The choke-capacitor type includes an iron-core choke having an inductance of not less than 10 henries which is placed in series with the plate and B-supply. The choke offers a very low resistance to the dc plate current component of the signal voltage but opposes the flow of the fluctuating component. A bypass capacitor of 2 to 6 microfarads supplies a path to the speaker winding for the signal voltage. The choke-coil output coupling device, however, is now only of historical interest.

The transformer type is constructed with two separate windings, a primary and a secondary wound on an iron core. This construction permits designing each winding to meet the requirements of its position in the circuit. Typical arrangements of each type of coupling device are shown in Fig. 87. Examples of transformers for push-pull stages are shown

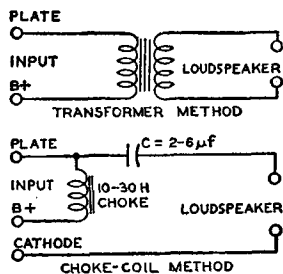

Fig. 87

in several of the circuits given in the **CIRCUIT SECTION**.

### High-Voltage Considerations for Television Picture Tubes

Like other high-voltage devices, television picture tubes require that certain precautions be observed to minimize the possibility of failure caused by humidity, dust, and corona.

**Humidity Considerations.** When humidity is high, a continuous film of moisture may form on the glass bulb immediately surrounding the ultor cavity cap of all-glass picture tubes or on the glass part of the envelope of metal picture tubes. This film may permit sparking to take place over the glass surface to the external conductive coating or to the metal shell. Such sparking may introduce noise into the receiver. To prevent such a possibility, the uncoated bulb surface around the cap and the glass part of the envelope of metal picture tubes should be kept clean and dry.

**Dust Considerations.** The accumulation of dust on the uncoated area of the bulb around the ultor cap of all-glass picture tubes or on the glass part of the envelope or insulating supports for metal picture tubes will decrease the insulating qualities of these parts. The dust usually consists of fibrous materials and may contain soluble salts. The fibers absorb and retain moisture; the soluble salts provide electrical leakage paths that increase in conductivity as the humidity increases. The resulting high leakage currents may overload the high-voltage power supply.

It is recommended, therefore, that the uncoated bulb surface of all-glass picture tubes and the coated glass surface and insulating supports for metal picture tubes be kept clean and free from dust or other contamination such as finger-prints. The frosted Filterglass faceplate of the metal picture tubes may be cleaned with a soapless detergent, such as Dreft, then rinsed with clean water, and immediately dried.

**Corona Considerations.** A high-voltage system may be subject to corona, especially when the humidity is high, unless suitable precautions are taken. Corona, which is an electrical discharge appearing on the surface of a conductor when the voltage gradient exceeds the breakdown value of air, causes deterior-

ration of organic insulating materials through formation of ozone, and induces arc-over at points and sharp edges. Sharp points or other irregularities on any part of the high-voltage system may increase the possibility of corona and should be avoided.

In the metal-shell picture tubes, the metal lip at the maximum diameter has rounded edges to prevent corona. Adequate spacing between the lip and any grounded element in the receiver, or between the small end of the metal shell and any grounded element, should be provided to preclude the possibility of corona. Such spacing should not be less than 1 inch of air. Similarly, an air space of 1 inch, or equivalent, should be provided around the body of the metal shell. As a further precaution to prevent corona, the deflecting-yoke surface on the end adjacent to the shell should present a smooth electrical surface with respect to the small end of the metal shell or the ultor terminal of all-glass tubes.

### **Picture-Tube Safety Considerations**

**Tube Handling.** Breakage of picture tubes, which contain a high vacuum, may result in injury from flying glass. Do not strike or scratch the tube or subject it to more than moderate pressure when installing it in or removing it from electronic equipment.

**High-Voltage Precautions.** In picture-tube circuits, high voltages may appear at normally low-potential points in the circuit because of capacitor breakdown or incorrect circuit connections. Therefore, before any part of the circuit is touched the power-supply switch should be turned off, the power plug disconnected, and both terminals of any capacitors grounded.

**X-Ray Radiation Precautions.** All types of picture tubes may be operated at voltages (if ratings permit) up to 16 kilovolts without producing harmful x-ray radiation or danger of personal injury on prolonged exposure at close range. Above 16 kilovolts, special x-ray shielding precautions may be necessary.



# Interpretation of Tube Data

The tube data given in the following TUBE TYPES SECTION include ratings, typical operation values, characteristics, and characteristic curves.

The values for grid-bias voltages, other electrode voltages, and electrode supply voltages are given with reference to a specified datum point as follows: For types having filaments heated with dc, the negative filament terminal is taken as the datum point to which other electrode voltages are referred. For types having filaments heated with ac, the mid-point (*i.e.*, the center tap on the filament-transformer secondary, or the mid-point on a resistor shunting the filament) is taken as the datum point. For types having unipotential cathodes indirectly heated, the cathode is taken as the datum point.

Electrode voltage and current ratings are in general self-explanatory, but a brief explanation of other ratings will aid in the understanding and interpretation of tube data.

**Plate dissipation** is the power dissipated in the form of heat by the plate as a result of electron bombardment. It is the difference between the power supplied to the plate of the tube and the power delivered by the tube to the load.

**Grid-No.2 (Screen-grid) Input** is the power applied to the grid-No. 2 electrode and consists essentially of the power dissipated in the form of heat by grid No.2 as a result of electron bombardment. With tetrodes and pentodes, the power dissipated in the screen-grid circuit is added to the power in the plate circuit to obtain the total B-supply input power.

**Peak heater-cathode voltage** is the highest instantaneous value of voltage that a tube can safely stand between its heater and cathode. This rating is applied to tubes having a separate cathode terminal and used in applications where excessive voltage may be introduced between heater and cathode.

**Maximum peak inverse plate voltage** is the highest instantaneous plate voltage which the tube can withstand recurrently in the direction opposite to that in which it is designed to pass current. For mercury-vapor tubes and gas-filled tubes, it is the safe top value to

prevent arc-back in the tube operating within the specified temperature range.

Referring to Fig. 88, when plate A of a full-wave rectifier tube is positive, current flows from A to C, but not from B to C, because B is negative. At the instant plate A is positive, the filament is positive (at high voltage) with respect to plate B. The voltage between the positive filament and the negative plate B is

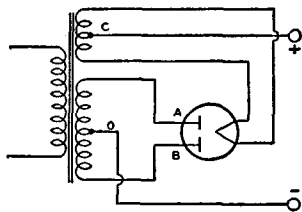

Fig. 88

in inverse relation to that causing current flow. The peak value of this voltage is limited by the resistance and nature of the path between plate B and filament. The maximum value of this voltage at which there is no danger of breakdown of the tube is known as maximum peak inverse voltage.

The relations between peak inverse voltage, rms value of ac input voltage, and dc output voltage depend largely on the individual characteristics of the rectifier circuit and the power supply. The presence of line surges or any other transient, or wave-form distortion, may raise the actual peak voltage to a value higher than that calculated for sine-wave voltages. Therefore, the actual inverse voltage, and not the calculated value, should be such as not to exceed the rated maximum peak inverse voltage for the rectifier tube. A calibrated cathode-ray oscillograph or a peak-indicating electronic voltmeter is useful in determining the actual peak inverse voltage.

In single-phase, full-wave circuits with sine-wave input and with no capacitor across the output, the peak inverse voltage on a rectifier tube is approximately 1.4 times the rms value of the plate voltage applied to the tube. In single-phase, half-wave circuits with

sine-wave input and with capacitor input to the filter, the peak inverse voltage may be as high as 2.8 times the rms value of the applied plate voltage. In polyphase circuits, mathematical determination of peak inverse voltage requires the use of vectors.

**Maximum dc output current** is the highest average plate current which can be handled continuously by a rectifier tube. Its value for any rectifier tube type is based on the permissible plate dissipation of that type. Under operating conditions involving a rapidly repeating duty cycle (steady load), the average plate current may be measured with a

dc meter. Curves of average plate characteristics for several half-wave vacuum rectifiers are given in Figs. 89 and 90. These curves are shown solid up to the maximum average or dc plate-current rating of each type.

**Maximum peak plate current** is the highest instantaneous plate current that a tube can safely carry recurrently in the direction of normal current flow. The safe value of this peak current in hot-cathode types of rectifier tubes is a function of the electron emission available and the duration of the pulsating current flow from the rectifier tube in each half-cycle.

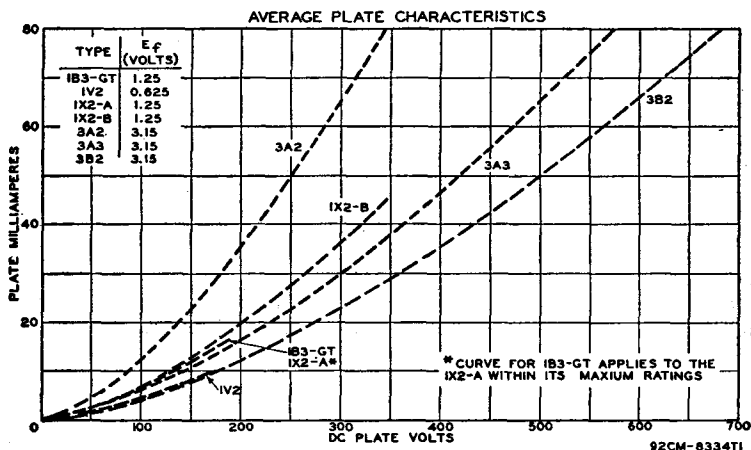

Fig. 89

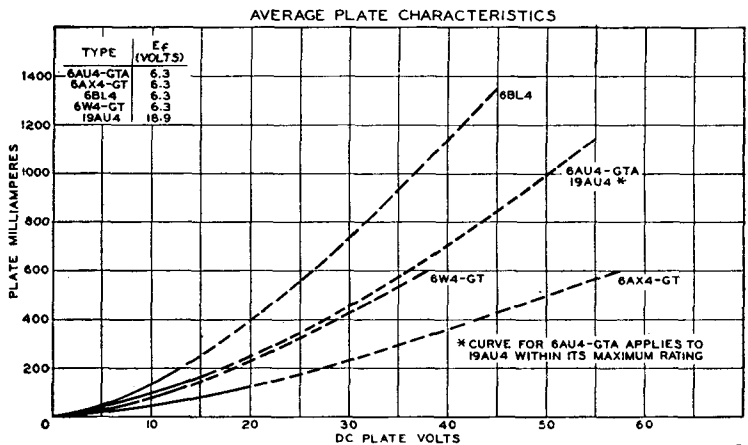

Fig. 90

The value of peak plate current in a given rectifier circuit is largely determined by filter constants. If a large choke is used at the filter input, the peak plate current is not much greater than the load current; but if a large capacitor is used as the filter input, the peak current may be many times the load current. In order to determine accurately the peak plate current in any rectifier circuit, measure it with a peak-indicating meter or use an oscillograph.

**Typical Operation Values.** Values for typical operation are given for many types in the TUBE TYPES SECTION. These typical operating values are given to show concisely some guiding information for the use of each type. These values should not be confused with ratings, because a tube can be used under any suitable conditions within its maximum ratings, according to the application.

The power output value for any operating condition is an approximate tube output—that is, plate input minus plate loss. Circuit losses must be subtracted from tube output in order to determine the useful output.

**Characteristics** are covered in the ELECTRON TUBE CHARACTERISTIC SECTION and such data should be interpreted in accordance with the definitions given in that section. **Characteristic curves** represent the characteristics of an average tube. Individual tubes, like any manufactured product, may have characteristics that range above or below the values given in the characteristic curves.

Although some curves are extended well beyond the maximum ratings of the tube, this extension has been made only for convenience in calculations. Do NOT operate a tube outside of its maximum ratings.

**Interelectrode capacitances** are direct capacitances measured between specified elements or groups of elements in electron tubes. Unless otherwise indicated in the data, all capacitances are measured with filament or heater cold, with no direct voltages present, and with no external shields. All electrodes other than those between which capacitance is being measured are grounded. In twin or multi-unit types, inactive units are also grounded.

The capacitance between the input electrode and all other electrodes, except the output electrode, connected together is commonly known as the input capacitance. The capacitance between the output electrode and all other electrodes, except the input electrode, connected together is known as the output capacitance.

**Ratings** for receiving-type tubes are given according to the "design-center" system, which was adopted by the industry in 1939, and should be interpreted as follows:

**1. CATHODE**—The heater or filament voltage is given as a normal value unless otherwise stated. This means that transformers or resistances in the heater or filament circuit should be designed to operate the heater or filament at rated value for full-load operating conditions under average supply-voltage conditions. A reasonable amount of leeway is incorporated in the cathode design so that moderate fluctuations of heater or filament voltage downward will not cause marked falling off in response; also moderate voltage fluctuations upward will not reduce the life of the cathode to an unsatisfactory degree.

**A. 1.4-Volt Battery Tube Types**—The filament power supply may be obtained from dry-cell batteries, from storage batteries, or from a power line. With dry-cell battery supply, the filament may be connected either directly across a battery rated at a terminal potential of 1.5 volts, or in series with the filaments of similar tubes across a power supply consisting of dry cells in series. In either case, the voltage across each 1.4-volt section of filament should not exceed 1.6 volts.

With power-line or storage-battery supply, the filament may be operated in series with the filaments of similar tubes. For such operation, design adjustments should be made so that, with tubes of rated characteristics, operating with all electrode voltages applied and on a normal line voltage of 117 volts or on a normal storage-battery voltage of 2.0 volts per cell (without a charger) or 2.2 volts per cell (with a charger), the voltage drop across each 1.4-volt section of filament will be maintained within a range of 1.25 to 1.4 volts with a nominal center

of 1.3 volts. In order to meet the recommended conditions for operating filaments in series from dry-battery, storage-battery, or power-line sources it may be necessary to use shunting resistors across the individual 1.4-volt sections of filament.

**B. 2.0-Volt Battery Tube Types**—The 2.0-volt line of tubes is designed to be operated with 2.0 volts across the filament. In all cases the operating voltage range should be maintained within the limits of 1.8 volts to 2.2 volts.

**2. POSITIVE POTENTIAL ELECTRODES**—The power sources for the operation of radio equipment are subject to variations in their terminal potential. Consequently, the maximum ratings shown on the tube-type data sheets have been established for certain Design Center Voltages which experience has shown to be representative. The Design Center Voltages to be used for the various power supplies together with other rating considerations are as given below:

**A. AC or DC Power Line Service in U.S.A.** The design center voltage for this type of power supply is 117 volts. The maximum ratings of plate voltages, screen-grid supply voltages, dissipations, and rectifier output currents are design maximums and should not be exceeded in equipment operated at a line voltage of 117 volts.

**B. Storage-Battery Service**—When storage-battery equipment is operated without a charger, it should be designed so that the published maximum values of plate voltages, screen-grid supply voltages, dissipations, and rectifier output currents are never exceeded for a terminal potential at the battery source of 2.0 volts per cell. When storage-battery equipment is operated with a charger, it should be designed so that 90 per cent of the same maximum values is never exceeded for a terminal potential at the battery source of 2.2 volts.

**C. "B"-Battery Service**—The design center voltage for "B" batteries is the normal voltage rating of the battery block, such as 45 volts, 90 volts, etc. Equipment should be designed so that under no condition of battery voltage will the plate voltages, screen-grid supply voltages, or dissipations ever exceed

the recommended respective maximum values shown in the data for each tube type by more than 10 per cent.

#### **D. Other Considerations**—

**a. Class A<sub>1</sub> Amplifiers**—The maximum plate dissipation occurs at the "Zero-Signal" condition. The maximum screen-grid dissipation usually occurs at the condition where the peak-input signal voltage is equal to the bias voltage.

**b. Class B Amplifiers**—The maximum plate dissipation theoretically occurs at approximately 63 per cent of the "Maximum-Signal" condition, but practically may occur at any signal voltage value.

**c. Converters**—The maximum plate dissipation occurs at the "Zero-Signal" condition and the frequency at which the oscillator-developed bias is a minimum. The screen-grid dissipation for any reasonable variation in signal voltage must never exceed the rated value by more than 10 per cent.

**d. Screen-Grid Ratings**—When the screen-grid voltage is supplied through a series voltage-dropping resistor, the maximum screen-grid voltage rating may be exceeded, provided the maximum screen-grid dissipation rating is not exceeded at any signal condition, and the maximum screen-grid voltage rating is not exceeded at the maximum-signal condition. Provided these conditions are fulfilled, the screen-grid supply voltage may be as high as, but not above, the maximum plate voltage rating.

For certain voltage amplifier types, as listed in the data section, the maximum permissible screen-grid (grid-No.2) input varies with the screen-grid voltage, as shown in Fig. 91. Full rated screen-grid input is permissible at screen-grid voltages up to 50 per cent of the maximum rated screen-grid supply voltage. From the 50-per-cent point to the full rated value of supply voltage, the screen-grid input must be decreased. The decrease in allowable screen-grid input follows a curve of the parabolic form. This rating chart is useful for applications utilizing either a fixed screen-grid voltage or a series screen-grid voltage-dropping resistor. When a fixed voltage is used, it is necessary only to determine that the screen-grid input is within the

boundary of the operating area on the chart at the selected value of screen-grid voltage to be used. When a voltage-dropping resistor is used, the minimum value of resistor that will assure tube operation within the boundary of the curve can be determined from the following relation:

$$R_{g2} \geq \frac{E_{c2} (E_{cc2} - E_{c2})}{P_{c2}}$$

where  $R_{g2}$  is the minimum value for the voltage-dropping resistor in ohms,  $E_{c2}$  is the selected screen-grid voltage in volts,  $E_{cc2}$  is the screen-grid supply voltage in volts, and  $P_{c2}$  is the screen-grid input in watts corresponding to  $E_{c2}$ .

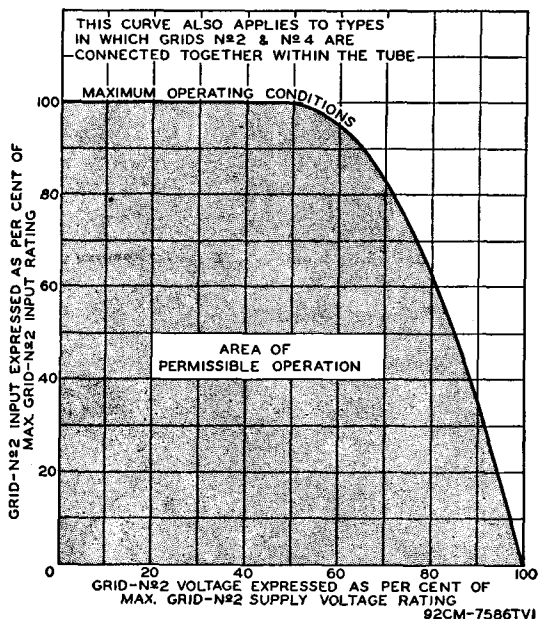
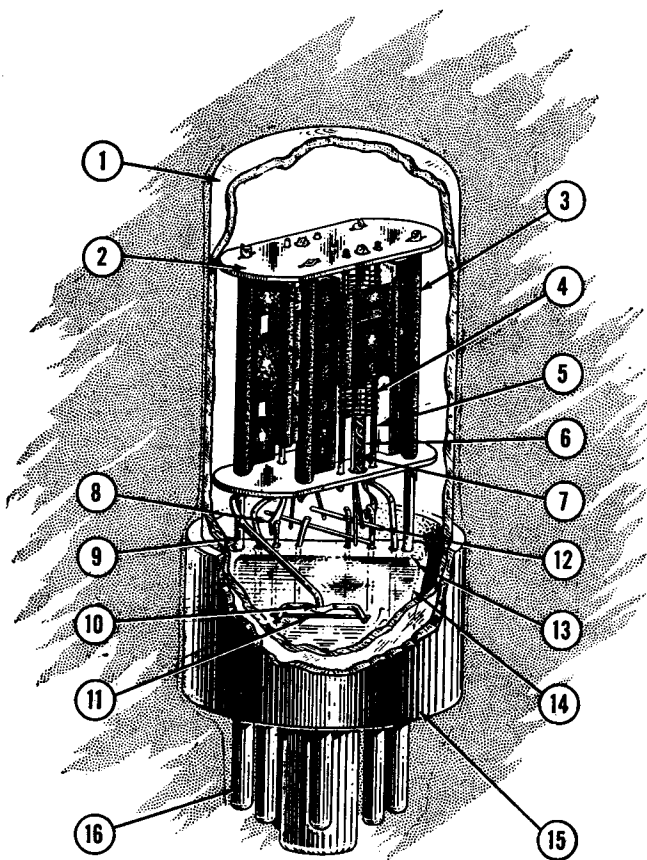

Fig. 91



## Tube-Part Materials in Typical RCA Electron Tube

- |  |  |
|--|--|
| 1. <b>ENVELOPE</b> —Lime glass   | 8. <b>CATHODE TAB</b> —Nickel                                    |
| 2. <b>SPACER</b> —Mica sprayed with magnesium oxide  | 9. <b>MOUNT SUPPORT</b> —Nickel or nickel-plated iron            |
| 3. <b>PLATE</b> —Carbonized nickel or nickel-plated steel                                  | 10. <b>GETTER SUPPORT AND LOOP</b> —Nickel or nickel-plated iron |
| 4. <b>GRID WIRES</b> —Manganese-nickel or molybdenum                                       | 11. <b>GETTER</b> —Barium-magnesium alloys                       |
| 5. <b>GRID SIDE-RODS</b> —Chrome copper, nickel, or nickel-plated iron                     | 12. <b>HEATER CONNECTOR</b> —Nickel or nickel-plated iron        |
| 6. <b>CATHODE</b> —Nickel coated with barium-calcium-strontium carbonates                  | 13. <b>STEM LEAD-IN WIRES</b> —Nickel, dumet, copper             |
| 7. <b>HEATER</b> —Tungsten or tungsten-molybdenum alloy with insulating coating of alundum | 14. <b>PRESSED STEM</b> —Lead glass                              |
|  | 15. <b>BASE</b> —Bakelite  |
|  | 16. <b>BASE PINS</b> —Nickel-plated brass                        |

# RCA Receiving Tube Classification Chart

RCA receiving tubes are classified in the following chart according to function and filament or heater voltage. Types having similar electrical characteristics are grouped in brackets. For more complete data on these types, refer to the TUBE TYPES SECTION. When choosing a tube type, refer to informa-

tion on *Preferred Types* and the listing of *Types Not Recommended for New Equipment Design* on the inside back cover. For information on picture tubes, refer to the RCA PICTURE TUBE CHARACTERISTICS CHART on pages 296 through 301. For explanation of symbols on charts, see page 71.

Filament or Heater Volts		1.25—1.4		2.0—5.0			6.3—117.0			
		Miniature	Other	Octal	Other	Miniature	Miniature	Octal	Other	
<b>RECTIFIERS (For rectifiers with amplifier units, see POWER AMPLIFIERS).</b>										
Half-Wave	vacuum	Peak Inverse Volts								
		Below 1500					35W4 117Z3	6AX4-GT 6W4-GT 12AX4-GTA† 17AX4-GT* 25W4-GT [35Z4-GT 35Z5-GT]	1-v 35Y4 35Z3	
		Above 1500	1AX2 1V2 [1X2-A] [1X2-B]	1B3-GT	3A3 3B2		3A2	6V3-A	6BL4 6BY5-GA 6AU4-6TA 19AU4	
Full-Wave	vacuum	Below 1500			[5Z4 5Y3-GT 5Y4-GT [5V4-G 5A24 80 83-V]			[6X4 12X4	6X5-GT 6AX5-GT	7Y4 7Z4 84/6Z4
		Above 1500			[5AS4 5T4 5U4-G 5U4-GB 5X4-C					
	gas	Below 1500						Cold-Cathode Types OZ4, OZ4-G		
Doubler	vacuum	Below 1500							[25Z6-GT [50Y6-GT 50Y7-GT] 117Z6-GT	25Z5] 50X6
<b>DIODE DETECTORS (For diode detectors with amplifier units, see VOLTAGE AMPLIFIERS and also POWER AMPLIFIERS).</b>										
One Diode			1A3							
Two Diodes							3AL5†	6AL5 12AL5	6H6 12H6	7A6
Three Diodes								6BC7		
<b>POWER AMPLIFIERS with and without Rectifiers, Diode Detectors, and Voltage Amplifiers.</b>										
Triodes	low-mu	single unit				2A3 45			6B4-G	
	high-mu	single unit						6BC4	6AC5-GT	
		twin unit							6AQ7-GT [6N7, 6N7-GT]	
Beam Tubes	single unit						3BN6†	6BN6 6AQ5 6AQ5-A* 6AS5 6BK5 6CU5 12AB5§ 12AQ5 12CA5† 12CU5† 25CA5	6AU5-GT 6AV5-GT 6BG6-G [6BQ6-GT [6BQ6-GTB/6CU6] [6CB5 6CB5-A] [6CD6-G 6CD6-GA] 6DG6-GT 6DQ6-A [6L6 6L6-G] [6V6 6V6-GT] 6W6-GT 6Y6-G 12BQ6-GTB/12CU6† 12DQ6-A† 12L6-GT† 12V6-GT 12W6-GT† 17BQ6-GTB*17DQ6-A* 19BG6-GA [25BQ6-GT [25BQ6-GTB/25CU6] 25CD6-GA† [25L6 25L6-GT] 35L6-GT 50C6-G 50L6-GT	7A5 7C5 35A5 50A5
			3Q5-GT* 3LF4				5AQ5†	[35B5 [35C5 [50B5 [50C5]		
	with rectifier								70L7-GT [117L7/M7-GT] 117P7-GT 117N7-GT	

# RCA Receiving Tube Manual

Filament or Heater Volts		1.25—1.4		2.0—5.0		6.3—117.0				
		Miniature	Other	Octal	Other	Miniature	Octal	Other		
<b>POWER AMPLIFIERS with and without Rectifiers, Diode Detectors, and Voltage Amplifiers.</b>										
Pentodes	single unit	[1S4] [3S4*] [3Q4*] [3V4*]	1A5-GT 1C5-GT 1LB4		47	[6CL6] [6AK6] 6AR5	6AG7 6C6-G [6F6, 6F6-G] [6F6-GT] [6K6-GT]	7B5 7AD7 42 41 43		
	with medium-mu triode						6AD7-G			
<b>CONVERTERS &amp; MIXERS (For other types used as Mixers, see VOLTAGE AMPLIFIERS).</b>										
Con-verters	pentagrid,	1E8† 1L6 1R5	1A7-GT 1LA6 1LC6		3BE6†	[6BE6] [2BE6] 12AD6* 12BA7 [6BA7]	6SA7 6SA7-GT 12SA7 12SA7-GT 6SB7-Y	[6A8, 6A8-GT 6A7] 7B8 707 14Q7		
	triode-pentode				[5AT8†] [5CG8†] [5X8†] 5U8†	[6AT8†] 6CC8 6U8 6X8 6CG8-A* 19X8				
	triode-hexode						6K8, 12K8			
	triode-heptode							7J7		
	octode							7A8		
Mixers	pentagrid						6L7			
<b>ELECTRON-RAY TUBES</b>										
Single	with remote-cutoff triode							6AB5/6N5 6U5		
	with sharp-cutoff triode							6E5		
Twin	without triode						6AF6-G			
Triple	without triode						6AL7-GT			
<b>VOLTAGE AMPLIFIERS with and without Diode Detectors; TRIODE, TETRODE, AND PENTODE DETECTORS; OSCILLATORS.</b>										
Triodes	medium-mu	single unit	1LE3		27	2AF4-A† 3AF4-A* 2BN4†	[6AF4, 6AF4-A] 6BN4 6C4 [6S4, 6S4-A†] 6T4 12B4-A*†	6AH4-GT [6C5, 6C5-GT] [6J5, 6J5-GT] 12J5-GT	7A4	
		with rf pentode				5AN8† 5AV8†	[6A8†] [6BH8†]	[6AN8] [6CH8] 6AZ8	6F7	
		with power pentode.							6AD7-G	
		with two diodes					12AE6* [6BF6] 12AJ6* [12BF6]	6SR7 6R7] 12SR7]		
		twin unit				4BQ7-A† [4BC8†] [4BZ7†] 5BQ7-A* 5J6†	[6BK7-A 6BC8] [6BQ7-A 6BZ7] 6J6 [6CG7†] 7AU7*† 12AU7* 8CG7* 12AV7* [12BH7*] 12BH7-A*† 19J6	6BL7-GT 6BX7-GT 6C8-C 6F8-G 6SN7-GTB† 12AH7-GT 12SN7-GT	7AF7 7F8 7N7 14AF7 14F8	
	dual unit						6CM7† 8CM7*			
	high-mu	single unit						6AB4	[6F5 6F5-GT] [6SF5, 6SF5-GT] 12SF5	7B4
		with diode		1H5-GT 1LH4						
		with two diodes				3AV6†	12AT6 [6AT6 6AQ6 6AV6]	6Q7, 6Q7-GT] 6SZ7 6SQ7, 6SQ7-GT] 12Q7-GT [12SQ7, 12SQ7-GT]	7B6 14B6 7C6 75 7K7 7X7	
		with three diodes				5T8†	6T8 19T8		6S8-GT	
twin unit						12AT7* 12AX7* 12AZ7*		6SC7 12SC7 6SL7-GT 12SL7-GT	7F7 14F7	
	with rf pentode					6AW8† 8AW8-A*				



# RCA Receiving Tube Manual

		Filament or Heater Volts 1.25—1.4		2.0—5.0		6.3—117.0			
		Miniature	Other	Octal	Other	Miniature	Octal	Other	
<b>VOLTAGE AMPLIFIERS with and without Diode Detectors;</b>									
<b>TRIODE, TETRODE, AND PENTODE DETECTORS; OSCILLATORS.</b>									
<b>Tetrodes</b>	sharp-cut-off				24-A				
	power						12K5°		
	remote-cut-off	single unit	1T4	1LC5			6BJ6 [6BD6 [12BD6 [6BA6 [12BA6 12AF6° 12BL6°	6SK7 [6SK7-GT 12SK7, [2SK7-GT 6SC7] 6AB7 12SC7] 6S7 6SS7 12K7-GT	78] 6D6 7A7 7AH7 7B7 7H7 14A7
		with triode							6F7
		with diode						12F8°	6SF7 12SF7
	with two diodes							12C8 6B8	7E7 7R7 14R7
	semi-remote-cut-off	single unit				3BZ6†	6BZ6	6DC6	
		with triode						6AZ8	
<b>Pentodes</b>	sharp-cut-off	single unit	1AD5† 1L4 1U4	1LC5 1LN5 1NS-GT		3AU6† [3BC5]† [3CB6]† [3CF6]† 3DT6† 4AU6* 4CB6* 4DT6*	6AC5 6AK5 [6AU6 [6BC5 6CB6 6CF6 6DT6 12AW6 12BY7-A*†	6AH6 [6AU6 [12AU6 6DE6 6BH6 6SH7]	6C6] 6I7, 6J7-GT, 6W7-G 7AG7 7C7 7C7 7L7 7V7 7W7 14C7
with triode						5AN8† 5AV8†	6AN6] [6AU8 [6CH8] [6BH8]† 6AW8†		
with diode		1S5 1U5	1LD5			5AM8† 5AS8†	6AM8 6AS8 6AM8-A*		
<b>GATED AMPLIFIERS</b>									
<b>Pentagrid Amplifier</b>						3BY6† 3CS6†	6BY6 6CS6		
<b>SHUNT VOLTAGE REGULATORS</b>									
<b>Beam Triode</b>								6BD4-A 6BK4	

† Subminiature type.

■ With dissimilar triode units.

‡ 600-milliamperes heater type having controlled warm-up time for use in series-string TV receivers.

\* Heater arranged for either 6.3- or 12.6-volt operation.

• Heater arranged for either 3.5- or 7.0-volt operation.

\* Filament arranged for either 1.4- or 2.8-volt operation.

\* 450-milliamperes heater type having controlled warm-up time for use in series-string TV receivers.

° For use in "hybrid" automobile receivers in which transistors are used in the output stage and tube and transistor electrode voltages are obtained directly from a 12.6-volt storage battery.

§ For use in automobile receivers operating from 12-volt storage batteries.

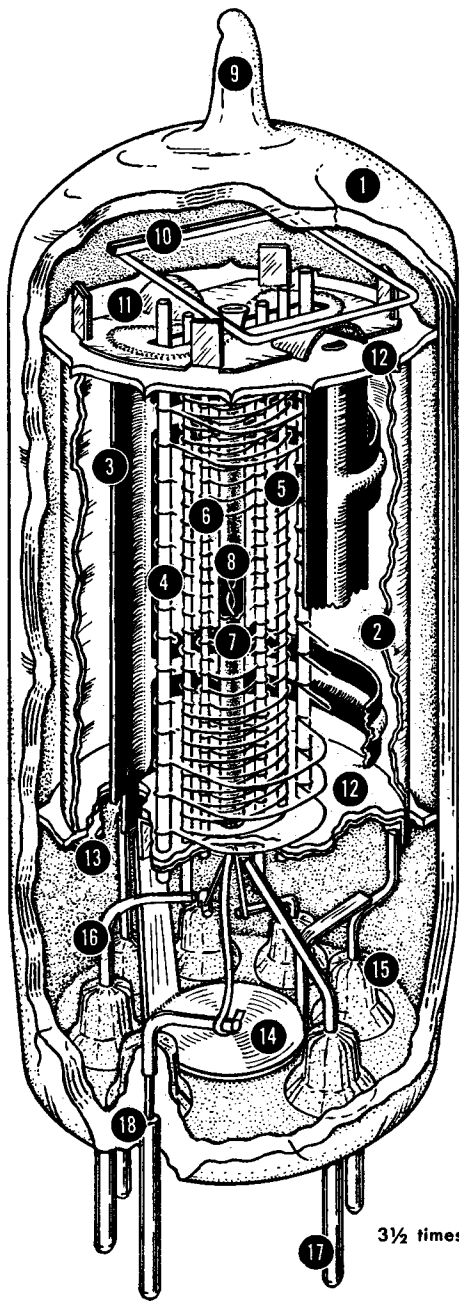

- 1—Glass Envelope
- 2—Internal Shield
- 3—Plate
- 4—Grid No. 3  
(Suppressor Grid)
- 5—Grid No. 2 (Screen Grid)
- 6—Grid No. 1 (Control Grid)
- 7—Cathode
- 8—Heater
- 9—Exhaust Tip
- 10—Getter
- 11—Spacer Shield Header
- 12—Insulating Spacer
- 13—Spacer Shield
- 14—Inter-Pin Shield
- 15—Glass Button-Stem Seal
- 16—Lead Wire
- 17—Base Pin
- 18—Glass-to-Metal Seal

3½ times actual size

## Structure of a Miniature Tube

# RCA Tube Types

This section contains technical descriptions of RCA tubes used in standard broadcast, FM, and television receivers. It includes data on current types, as well as information on those RCA discontinued types in which there may still be some interest as to characteristics. Information on picture tubes is contained in a chart at the end of this section.

In choosing tube types for the design of new electronic equipment, the designer is referred to the inside back cover for information regarding the availability of the latest **RCA Preferred Types List** and for a listing of **RCA Tube Types Not Recommended for New Equipment Design**.

Tube types are listed in this section according to the numerical-alphabetical-numerical sequence of their type designations. For **Key to Socket Connection Diagrams**, see inside front cover.

## FULL-WAVE GAS RECTIFIER

Metal type OZ4 and glass octal type OZ4-G are used in vibrator-type B-supply units. Both have ionically heated cathodes, require octal sockets, and may be mounted in any position. OZ4 Outline 2, OUTLINES SECTION. OZ4-G dimensions: maximum over-all length, 2-5/8 inches; maximum diameter, 1-1/16 inches; T-7 bulb; dwarf-shell octal 5-pin base. Base of OZ4-G has no pin No. 2. Shell of OZ4 and external shield of OZ4-G should be grounded. Filters may be necessary to eliminate objectionable noise. Maximum ratings for full-wave rectifier service: peak starting supply volts (per plate), 300 *min*; peak plate-to-plate volts, 1000 *max*; peak plate ma. (per plate), 200 *max*; dc output ma., 75 *max*, 30 *min*; dc output volts, 300 *max*; average dynamic tube voltage drop, 24 volts. These types are used principally for renewal purposes.

**OZ4**  
**OZ4-G**

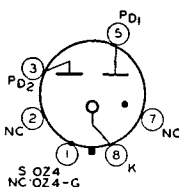

Maximum ratings for full-wave rectifier service: peak starting supply volts (per plate), 300 *min*; peak plate-to-plate volts, 1000 *max*; peak plate ma. (per plate), 200 *max*; dc output ma., 75 *max*, 30 *min*; dc output volts, 300 *max*; average dynamic tube voltage drop, 24 volts. These types are used principally for renewal purposes.

## DIODE

Miniature type used as detector tube in portable FM receivers and in portable high-frequency measuring equipment. Outline 11, OUTLINES SECTION. Tube requires miniature seven-contact socket. Heater volts (ac/dc) 1.4; amperes, 0.15.

**1A3**

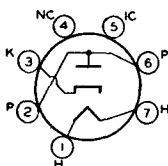

### Maximum Ratings:

PEAK INVERSE PLATE VOLTAGE.....	330 <i>max</i>	volts
PEAK PLATE CURRENT.....	5 <i>max</i>	ma
DC OUTPUT CURRENT.....	0.5 <i>max</i>	ma
PEAK HEATER-CATHODE VOLTAGE.....	140 <i>max</i>	volts

330 <i>max</i>	volts
5 <i>max</i>	ma
0.5 <i>max</i>	ma
140 <i>max</i>	volts

### Typical Operation (With Capacitor-Input Filter):

AC Plate-Supply Voltage (rms).....	117	volts
Filter-Input Capacitor.....	2	$\mu$ f
Minimum Total Effective Plate-Supply Impedance.....	0	ohms

117	volts
2	$\mu$ f
0	ohms

**REMOTE-CUTOFF PENTODE**

Glass type used in battery-operated receivers as rf or if amplifier. This type is similar electrically to type 1D5-GP. Outline 23, OUTLINES SECTION. Tube requires four-contact socket. Filament volts (dc), 2.0; amperes, 0.06. Type 1A4-P is a DISCONTINUED type listed for reference only.

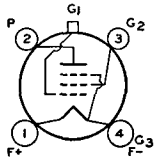

**1A4-P**

**POWER PENTODE**

Glass octal type used in output stage of battery-operated receivers. Outline 23, OUTLINES SECTION. This type may be supplied with pin No.1 omitted. Tube requires octal socket and may be mounted in any position. For filament considerations, refer to type 1U4. Filament volts (dc), 1.4; amperes, 0.05. Typical operation as class A<sub>1</sub> amplifier: plate and grid-No.2 volts, 90 (110 max); grid-No.1 volts, -4.5; peak af grid-

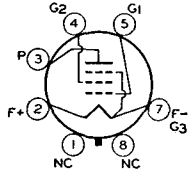

**1A5-GT**

No.1 volts, 4.5; plate ma., 4.0; grid-No.2 ma., 1.1; plate resistance (approx.), 0.3 megohm; transconductance, 850 μmhos; load resistance, 25000 ohms; power output, 115 milliwatts. Type 1A5-GT is used principally for renewal purposes.

**PENTAGRID CONVERTER**

Glass type used in battery-operated receivers. This type is identical electrically with type 1D7-G, except for interelectrode capacitances. Outline 39, OUTLINES SECTION. Tube requires six-contact socket. Filament volts (dc), 2.0; amperes, 0.06. Type 1A6 is a DISCONTINUED type listed for reference only.

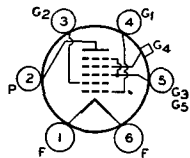

**1A6**

**PENTAGRID CONVERTER**

Glass octal type used in superheterodyne circuits having battery power supplies. Outline 24, OUTLINES SECTION. Tube requires octal socket and may be mounted in any position. For filament considerations, refer to 1U4.

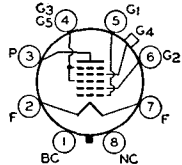

**1A7-GT**

FILAMENT VOLTAGE (DC) . . . . . 2.0  
 FILAMENT CURRENT . . . . . 0.06

1.4 volts  
 0.05 ampere

**CONVERTER SERVICE**

**Maximum Ratings:**

PLATE VOLTAGE . . . . .	110 max	volts
GRIDS-NO.3-AND-NO.5 (SCREEN-GRID) VOLTAGE . . . . .	60 max	volts
GRIDS-NO.3-AND-NO.5 SUPPLY VOLTAGE . . . . .	110 max	volts
GRID-NO.2 (ANODE-GRID) VOLTAGE . . . . .	110 max	volts
TOTAL ZERO-SIGNAL CATHODE CURRENT . . . . .	4 max	ma

**Typical Operation:**

Plate Voltage . . . . .	90	volts
Grids-No.3-and-No.5 Voltage* . . . . .	45	volts
Grid-No.2 Voltage . . . . .	90	volts
Grid-No.4 (Control-Grid) Voltage** . . . . .	0	volts
Grid-No.1 (Oscillator-Grid) Resistor . . . . .	0.2	megohm
Plate Resistance . . . . .	0.6	megohm
Conversion Transconductance . . . . .	250	μmhos
Conversion Transconductance with grid-No.4 bias of -3 volts (Approx.). . . . .	20	μmhos
Plate Current . . . . .	0.6	ma
Grids-No.3-and-No.5 Current . . . . .	0.7	ma
Grid-No.2 Current . . . . .	1.2	ma
Grid-No.1 Current . . . . .	0.035	ma
Total Cathode Current . . . . .	2.5	ma

\* Obtained preferably by using a bypassed 45000- to 75000-ohm voltage-dropping resistor in series with the 90-volt supply.

\*\* A resistance of at least 1.0 megohm should be in the grid return to negative filament pin.

**POWER PENTODE**

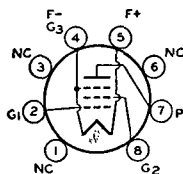

Subminiature type used in output stage of small, compact, battery-operated receivers for the standard AM broadcast band. Outline 8, OUTLINES SECTION. Tube requires subminiature eight-contact socket and may be mounted in any position. Base pins should not be soldered to circuit elements because heat of soldering operation may crack the glass seal. Filament volts (dc), 1.25; amperes, 0.04. The

**1AC5**

filament may be connected directly across a dry-cell battery rated at a terminal potential of 1.5 volts. Filament voltage should never exceed 1.6 volts. Typical operation as class A<sub>1</sub> amplifier: plate and grid-No.2 volts, 67.5 max; grid-No.1 volts, -4.5; peak af grid-No.1 volts, 4.5; zero-signal plate ma., 2; zero-signal grid-No.2 ma., 0.4; cathode ma., 4 max; plate resistance, 0.15 megohm; transconductance, 750 μmhos; load resistance, 25000 ohms; total harmonic distortion, 10 per cent; maximum-signal power output, 50 milliwatts. This is a DISCONTINUED type listed for reference only.

**SHARP-CUTOFF PENTODE**

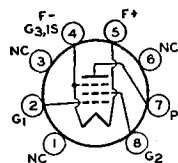

Subminiature type used as rf or if amplifier in stages not controlled by avc in small, compact, battery-operated receivers for the standard AM broadcast band. Outline 8, OUTLINES SECTION. Tube requires subminiature eight-contact socket and may be mounted in any position. Base pins should not be soldered to circuit elements because the heat of the soldering operation may crack the glass seal. Filament volts

**1AD5**

(dc), 1.25; amperes, 0.04. Filament may be connected directly across a dry-cell battery rated at a terminal potential of 1.5 volts. Filament voltage should never exceed 1.6 volts. Maximum ratings: plate and grid-No.2 volts, 67.5 max; total cathode ma., 4 max. This type is used principally for renewal purposes.

**Typical Operation:**

**CLASS A<sub>1</sub> AMPLIFIER**

Plate Voltage	30	45	67.5	volts
Grid-No.2 (Screen-Grid) Voltage	30	45	67.5	volts
Grid-No.1 (Control-Grid) Voltage	0	0	0	volts
Plate Resistance (Approx.)	0.7	0.7	0.7	megohm
Transconductance	430	580	735	μmhos
Grid-No.1 Bias (Approx.) for plate current of 10 μa	-3	-4	-6	volts
Plate Current	0.45	0.9	1.85	ma
Grid-No.2 Current	0.16	0.35	0.75	ma

**HALF-WAVE VACUUM RECTIFIER**

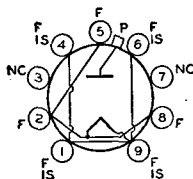

Miniature type used as rectifier of high-voltage pulses produced in the scanning systems of television receivers. Outline 17, OUTLINES SECTION. Tube requires miniature nine-contact socket and may be mounted in any position. Plate connection is cap at top of bulb. Pin No.3 may be connected to the filament, or used as a tie point for the filament-dropping resistor; otherwise it should not be used. For filament

**1AX2**

and high-voltage considerations, refer to type 1B3-GT. Type 1AX2 is used principally for renewal purposes.

FILAMENT VOLTAGE (AC)	1.4	volts
FILAMENT CURRENT	0.65	ampere
DIRECT INTERELECTRODE CAPACITANCE:		
Plate to Filament	0.7 max	μf

**PULSED-RECTIFIER SERVICE**

For operation in a 525-line, 30-frame system

**Maximum Ratings:**

PEAK INVERSE PLATE VOLTAGE (Absolute Maximum)	25000 max	volts
PEAK PLATE CURRENT	11 max	ma
AVERAGE PLATE CURRENT	1 max	ma

## Typical Operation:

### Peak Plate-Supply Voltage:

Positive pulse value.....	20000	volts
Negative pulse value.....	-5000	volts
DC Output Voltage (Approx.).....	20000	volts
DC Output Current (Approx.).....	300	μa

■ Under no circumstances should this absolute value be exceeded.

## HALF-WAVE VACUUM RECTIFIER

# 1B3-GT

Glass octal type used in high-voltage, low-current applications such as the rectifier in a high-voltage, rf-operated power supply or as a rectifier of high-voltage pulses produced in television

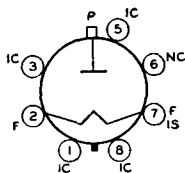

scanning systems. When used as an rf rectifier, one 1B3-GT in a half-wave circuit is capable of delivering a maximum dc output voltage of about 15000 volts. In a voltage-doubler circuit, two tubes will give about 30000 volts; and in a voltage-tripler circuit, three 1B3-GT's will deliver 45000 volts approximately. For curve of average plate characteristics, see page 64.

FILAMENT VOLTAGE (AC/DC).....	1.25*	volts
FILAMENT CURRENT.....	0.2	ampere
DIRECT INTERELECTRODE CAPACITANCE:		
Plate to Filament (Approx.).....	1.5	μf

\*Under no circumstances should the filament voltage be less than 1.1 volts or greater than 1.5 volts.

### PULSED-RECTIFIER SERVICE

*For operation in a 525-line, 30-frame system*

#### Maximum Ratings:

PEAK INVERSE PLATE VOLTAGE.....	30000 max	volts
PEAK PLATE CURRENT.....	17 max	ma
AVERAGE PLATE CURRENT.....	2 max	ma
FREQUENCY OF SUPPLY VOLTAGE.....	300 max	Kc

## INSTALLATION AND APPLICATION

Type 1B3-GT requires an octal socket and may be mounted in any position. Plate connection is cap at top of bulb. Internal connections are made to pins 1, 3, 5, and 8. These pins may be connected to pin 7; otherwise they should not be used. This type may be supplied with pin No.1 and/or pin No.6 omitted. Outline 32, OUTLINES SECTION.

The high voltages at which the 1B3-GT is operated are very dangerous. Great care should be taken to prevent coming in contact with these high voltages. In those circuits where the filament circuit is not grounded, the filament circuit operates at dc potentials which can cause fatal shock. Extreme precautions must be taken when the filament voltage is measured. These precautions must include safeguards which definitely eliminate all hazards to personnel. The filament transformer, whether it is of the iron-core or the air-core type, must be sufficiently insulated.

When used in television receivers and other equipment operating at 16000 volts or above, the 1B3-GT will produce X-rays which can constitute a health hazard unless the tube is adequately shielded.

### SHARP-CUTOFF PENTODE

Glass type used as rf amplifier or detector in battery-operated receivers. Outline 39, OUTLINES SECTION. Tube requires four-contact socket. For typical operating conditions and maximum ratings as a class A<sub>1</sub> amplifier, refer to type 1E5-GP. Filament volts (dc), 2.0; amperes, 0.06. Type 1B4-P is a DISCONTINUED type listed for reference only.

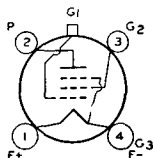

# 1B4-P

## TWIN DIODE—MEDIUM-MU TRIODE

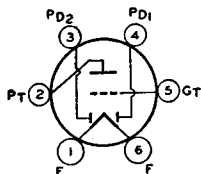

Glass type used as combined detector, amplifier, and avc tube in battery-operated receivers. Outline 34 or 35, OUTLINES SECTION. Tube requires six-contact socket. Filament volts (dc), 2.0 amperes, 0.06. Typical operation as class A<sub>1</sub> amplifier: plate volts, 135 *max*; grid volts, -3; plate ma., 0.8; plate resistance, 35000 ohms; amplification factor, 20; transconductance, 575  $\mu$ mhos. This is a DISCONTINUED type listed for reference only.

### 1B5/25S

## PENTAGRID CONVERTER

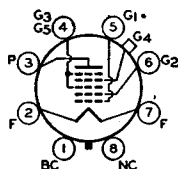

Glass octal type used in superheterodyne circuits having battery power supply. Outline 24, OUTLINES SECTION. Filament volts (dc), 1.4; amperes, 0.1. This is a DISCONTINUED type listed for reference only. The 1B7-GT may be replaced by the 1A7-GT if circuit adjustment is made for lower filament current of type 1A7-GT.

### 1B7-GT

## POWER PENTODE

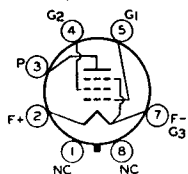

Glass octal type used in output stage of battery-operated receivers. Outline 23, OUTLINES SECTION. This type may be supplied with pin No.1 omitted. Tube requires octal socket and may be mounted in any position. For filament considerations, refer to 1U4. Filament volts (dc), 1.4; amperes, 0.1. Typical operation as class A<sub>1</sub> amplifier: plate and grid-No.2 volts, 90 (110 *max*); grid-No.1 volts, -7.5; peak

### 1C5-GT

af grid-No.1 volts, 7.5; plate ma., 7.8; grid-No.2 ma., 3.5; plate resistance (approx.), 115000 ohms; transconductance, 1550  $\mu$ mhos; load resistance, 8000 ohms; power output, 240 milliwatts. Type 1C5-GT is used principally for renewal purposes.

## PENTAGRID CONVERTER

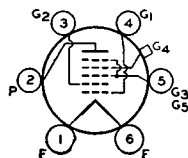

Glass type used in battery-operated receivers. Similar electrically to type 1C7-G except for interelectrode capacitances. Outline 39, OUTLINES SECTION. Tube requires six-contact socket. Filament volts (dc), 2.0; amperes, 0.12. Type 1C6 is a DISCONTINUED type listed for reference only.

### 1C6

## PENTAGRID CONVERTER

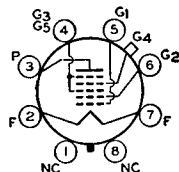

Glass octal type used in battery-operated receivers. Outline 38, OUTLINES SECTION. Tube requires octal socket. Filament volts (dc), 2.0; amperes, 0.12. Typical operation as converter: plate volts, 180 *max*; grids-No.3-and-No.5 (screen-grid) volts, 67.5 *max*; grid-No.2 (anode-grid) supply volts, 180 (applied through 20000-ohm dropping resistor bypassed by 0.01- $\mu$ f capacitor); grid-No.4 (control-grid) volts, -3;

### 1C7-G

grid-No.1 (oscillator-grid) resistor, 50000 ohms; plate ma., 1.5; grids-No.3-and-No.5 ma., 2; grid-No.2 ma., 4; grid-No.1 ma., 0.2. This is a DISCONTINUED type listed for reference only.

## REMOTE-CUTOFF PENTODE

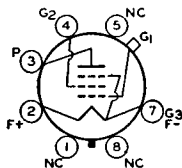

Glass octal type used in battery-operated receivers as rf or if amplifier. Outline 38, OUTLINES SECTION. Tube requires octal socket. Filament volts (dc), 2.0; amperes, 0.06. Typical operation as class A<sub>1</sub> amplifier: plate volts, 180 *max*; grid-No.2 (screen-grid) volts, 67.5 *max*; grid-No.1 volts, -3 *min*; plate ma., 2.3; grid-No.2 ma., 0.8; plate resistance (approx.), 1.0 megohm; transconductance, 750  $\mu$ mhos; transconductance at bias of -15 volts, 15  $\mu$ mhos. This is a DISCONTINUED type listed for reference only.

### 1D5-GP

**REMOTE-CUTOFF TETRODE**

**1D5-GT**

Glass octal type used in battery-operated receivers as rf or if amplifier. Outline 38, OUTLINES SECTION. Filament volts (dc), 2.0; amperes, 0.06. This is a DISCONTINUED type listed for reference only. It is similar electrically to type 1D5-GP.

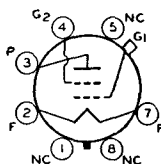

**PENTAGRID CONVERTER**

**1D7-G**

Glass octal type used in battery-operated receivers. Outline 38, OUTLINES SECTION. Tube requires octal socket. Filament volts (dc), 2.0; amperes, 0.06. Typical operation as converter: plate volts, grids-No.3-and-No.5 volts, grid-No.2 supply volts, grid-No.4 volts, and grid-No.1 resistor are same as for type 1C7-G; plate ma., 1.3; grids-No.3-and-No.5 ma., 2.4; grid-No.2 ma., 2.3; grid-No.1 ma., 0.2. This is a DISCONTINUED type listed for reference only.

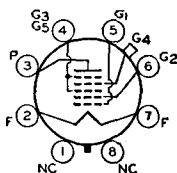

**DIODE—TRIODE—POWER PENTODE**

**1D8-GT**

Glass octal type used in compact battery-operated receivers. Diode unit is used as detector or avc tube, triode as first audio amplifier, and pentode as power output tube. Outline 21, OUTLINES SECTION. Filament volts (dc), 1.4; amperes, 0.1. Typical operation of pentode unit as class A<sub>1</sub> amplifier: plate and grid-No.2 volts, 90 (110 max); grid-No.1 volts, -9; plate ma., 5; grid-No.2 ma., 1;

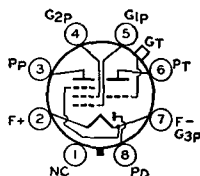

transconductance, 925  $\mu$ hos; load resistance, 12000 ohms; total harmonic distortion, 10 per cent; power output, 200 milliwatts. Characteristics of triode unit as class A<sub>1</sub> amplifier: plate volts, 90 (110 max); grid volts, 0; amplification factor, 25; plate resistance (approx.), 43500 ohms; transconductance, 575  $\mu$ hos; plate ma., 1.1. This is a DISCONTINUED type listed for reference only.

**SHARP-CUTOFF PENTODE**

**1E5-GP**

Glass octal type used as rf amplifier or detector in battery-operated receivers. Outline 38, OUTLINES SECTION. Tube requires octal socket. Filament volts (dc), 2.0; amperes, 0.06. Typical operation as class A<sub>1</sub> amplifier: plate volts, 180 max; grid-No.2 (screen-grid) volts, 67.5 max; grid-No.1 volts, -3; plate ma., 1.7; grid-No.2 ma., 0.6; plate resistance, 1.5 megohms; transconductance, 650  $\mu$ hos; grid volts for

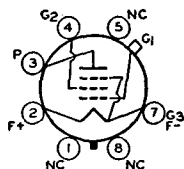
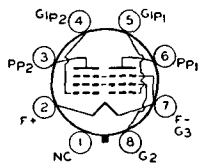

plate-current cutoff (approx.), -8. This is a DISCONTINUED type listed for reference only.

**TWIN POWER PENTODE**

**1E7-GT**

Glass octal type used in push-pull output stage of battery-operated receivers. Outline 23, OUTLINES SECTION. Tube requires octal socket. Filament volts (dc), 2.0; amperes, 0.24. Typical operation as push-pull class A<sub>1</sub> amplifier: plate and grid-No.2 volts, 135 max; grid-No.1 volts, -7.5; plate ma., 10.5; grid-No.2 ma., 3.5; output watts, 0.575. The two units are used in the same manner as two separate tubes in



conventional push-pull audio-frequency amplifier circuits. This is a DISCONTINUED type listed for reference only.

**PENTAGRID CONVERTER**

**1E8**

Subminiature type used in small, compact, battery-operated receivers for the standard AM broadcast band. Outline 8, OUTLINES SECTION. Tube requires subminiature eight-contact socket and may be mounted in any position. Base pins should not be soldered to circuit elements because the heat of the soldering operation may crack the glass seal. Filament volts (dc), 1.25; amperes, 0.04. Filament may be con-

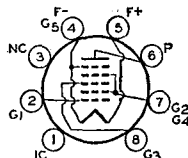



nected directly across a dry-cell battery rated at a terminal potential of 1.5 volts. Filament voltage should never exceed 1.6 volts. Maximum ratings: plate volts, 67.5 *max*; grids-No.2-and-No.4 (screen-grid) volts, 45 *max*; grids-No.2-and-No.4 supply volts, 67.5 *max*; total cathode ma., 4 *max*. This type is used principally for renewal purposes.

## CONVERTER SERVICE

Characteristics: (Separate Excitation): #

Plate Voltage.....	30	45	67.5	volts
Grids-No.2 and No.4 Supply Voltage.....	30	45	67.5	volts
Grids-No.2 and No.4 Resistor.....	10000	15000	20000	ohms
Grid-No.3 (Control-Grid) Voltage.....	0	0	0	volts
Grid-No.1 (Oscillator-Grid) Resistor.....	0.1	0.1	0.1	megohm
Plate Resistance (Approx.).....	0.3	0.4	0.4	megohm
Conversion Transconductance.....	115	140	150	$\mu$ mhos
Grid-No.3 Voltage for Conversion Transconductance of 5 $\mu$ mhos (Approx.).....	-7	-8	-9	volts
Plate Current.....	0.3	0.6	1.0	ma
Grids-No.2 and No.4 Current.....	0.8	1.1	1.5	ma
Grid-No.1 Current.....	30	50	70	$\mu$ a
Total Cathode Current.....	1.1	1.7	2.5	ma

NOTE: The transconductance between grid No.1 and grids No.2 and No.4 connected to plate (not oscillating) is approximately 730  $\mu$ mhos under the following conditions: signal applied to grid No.1 at zero bias; grids No.2 and No.4 and plate at 30 volts; and grid No.3 grounded. Under the same conditions, the total cathode current is 3 milliamperes and the amplification factor is 3.9.

#The characteristics shown under separate excitation approximate those obtained in a self-excited oscillator operating with zero bias.

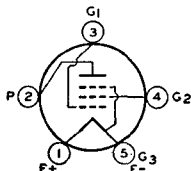

## POWER PENTODE

Glass type used in output stage of battery-operated receivers. Outline 42, OUTLINES SECTION. Tube requires five-contact socket. Filament volts (dc), 2.0; amperes, 0.12. Type 1F4 is similar electrically to type 1F5-G. Type 1F4 is a DISCONTINUED type listed for reference only.

### 1F4

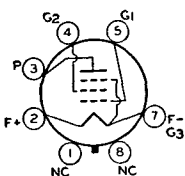

## POWER PENTODE

Glass octal type used in output stage of battery-operated receivers. Outline 41, OUTLINES SECTION. Tube requires octal socket. Filament volts (dc), 2.0; amperes, 0.12. Typical operation as class A<sub>1</sub> amplifier: plate and grid-No.2 (screen-grid) volts, 135 (180 *max*); grid-No.1 volts, -4.5; plate ma., 8; grid-No.2 ma., 2.4; cathode resistor, 432 ohms; output watts, 0.31. This is a DISCONTINUED type listed for reference only.

### 1F5-G

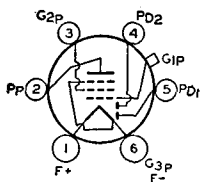

## TWIN DIODE— SHARP-CUTOFF PENTODE

Glass type used as combined detector, amplifier, and avc tube in battery-operated receivers. Outline 38, OUTLINES SECTION. Tube requires six-contact socket. Filament volts (dc), 2.0; amperes, 0.06. Typical operation of pentode unit as class A<sub>1</sub> amplifier: plate volts, 180 *max*; grid-No.2 (screen-grid) volts, 67.5 *max*; grid-No.1 volts, -1.5; plate ma., 2.2; grid-No.2 ma., 0.7. This is a DISCONTINUED type listed for reference only.

### 1F6

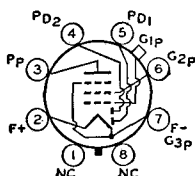

## TWIN DIODE— SHARP-CUTOFF PENTODE

Glass octal type used as combined detector, amplifier, and avc tube in battery-operated receivers. Outline 38, OUTLINES SECTION. Tube requires octal socket. Filament volts (dc), 2.0; amperes, 0.06. Similar electrically to type 1F6 except for interelectrode capacitances. Type 1F7-G is a DISCONTINUED type listed for reference only.

### 1F7-G

**MEDIUM-MU TRIODE**

Glass octal type used in battery-operated receivers as detector or voltage amplifier. Outline 23, OUTLINES SECTION. This type may be supplied with pin No.1 omitted. Tube requires octal socket. Filament volts (dc), 1.4; amperes, 0.05. Typical operation and characteristics as class A<sub>1</sub> amplifier: plate volts, 90 (110 *max*); grid volts, -6; plate ma., 2.3; plate resistance, 10700 ohms; amplification factor, 8.8; transconductance, 825  $\mu$ mhos. This is a DISCONTINUED type listed for reference only.

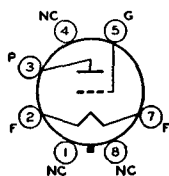

**1G4-GT**

**POWER PENTODE**

Glass octal type used in output stage of battery-operated receivers. Outline 41, OUTLINES SECTION. Tube requires octal socket. Filament volts (dc), 2.0; amperes, 0.12. Typical operation as class A<sub>1</sub> amplifier: plate and grid-No.2 (screen-grid) volts, 135 *max*; grid-No.1 volts, -13.5; plate ma., 9.7; output watts, 0.55. This is a DISCONTINUED type listed for reference only.

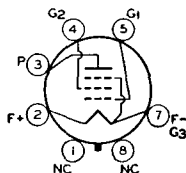

**1G5-G**

**HIGH-MU TWIN POWER TRIODE**

Glass octal type used in output stage of battery-operated receivers. Outline 23, OUTLINES SECTION. Tube requires octal socket. Filament volts (dc), 1.4; amperes, 0.1. Typical operation as class B amplifier: plate volts, 90 (110 *max*); dc grid volts, 0; peak af grid-to-grid volts, 48; effective grid-circuit impedance per unit, 2530 ohms; plate ma. (zero signal), 2; plate ma. (maximum signal), 11; peak grid ma.

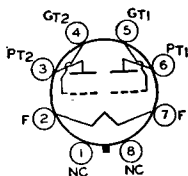

**1G6-GT**

per unit, 6; output watts (approx), 0.35. This is a DISCONTINUED type listed for reference only.

**MEDIUM-MU TRIODE**

Glass octal type used as detector or voltage amplifier in battery-operated receivers. Outline 36, OUTLINES SECTION. This type may be supplied with pin No.1 omitted. Tube requires octal socket. Filament volts (dc), 2.0; amperes, 0.06. Typical operation as class A<sub>1</sub> amplifier: plate volts, 180 *max*; grid volts, -13.5; amplification factor, 9.3; plate resistance, 10300 ohms; transconductance, 900  $\mu$ mhos; plate ma., 3.1.

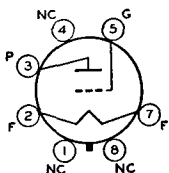

**1H4-G**

For grid-bias detection, plate volts up to 180 *max* may be used and grid bias adjusted so that zero-signal plate ma. is about 0.2. This is a DISCONTINUED type listed for reference only.

**DIODE—HIGH-MU TRIODE**

Glass octal type used as combined detector and amplifier in battery-operated receivers. Outline 24, OUTLINES SECTION. Tube requires octal socket. Filament volts (dc), 1.4; amperes, 0.05.

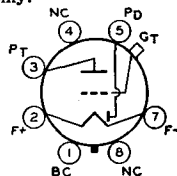

**1H5-GT**

Characteristics of triode unit as class A<sub>1</sub> amplifier: plate volts, 90 (110 *max*); grid volts, 0; plate ma., 0.15; plate resistance, 240000 ohms; amplification factor, 65; transconductance, 275  $\mu$ mhos. Diode is located at negative end of filament.

**TWIN DIODE—MEDIUM-MU TRIODE**

Glass octal type used as combined detector, amplifier, and avc tube in battery-operated receivers. Outline 36, OUTLINES SECTION. Tube requires octal socket. Filament volts (dc), 2.0; amperes, 0.06. Type 1H6-G is similar electrically to type 1B5/25S. Type 1H6-G is a DISCONTINUED type listed for reference only.

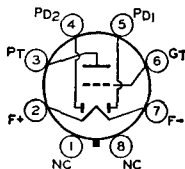

**1H6-G**

**POWER PENTODE**

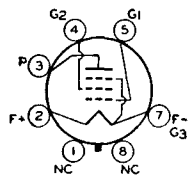

Glass octal type used in output stage of battery-operated receivers. Outline 41, OUTLINES SECTION. Tube requires octal socket. Filament volts (dc), 2.0; amperes, 0.12. Typical operation as class A<sub>1</sub> amplifier: plate and grid-No.2 (screen-grid) volts, 135 max; grid-No.1 volts, -16.5; plate ma., 7.0; grid-No.2 ma., 2.0; plate resistance, 105000 ohms; load resistance, 13500 ohms; output watts, 0.45. This is a DISCONTINUED type listed for reference only.

**1J5-G**

**HIGH-MU TWIN POWER TRIODE**

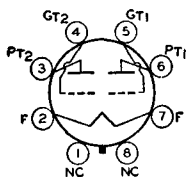

Glass octal types used in output stage of battery-operated receivers. Type 1J6-G, Outline 36; type 1J6-GT, Outline 27, OUTLINES SECTION. Tubes require octal socket. Filament volts (dc), 2.0; amperes, 0.24. Typical operation as class B power amplifier: plate volts, 135 max; peak plate ma. per plate, 50 max; grid volts, 0; zero-signal plate ma. per plate, 5; effective plate-to-plate load resistance, 10000

**1J6-G  
1J6-GT**

ohms; average input watts, 0.17; output watts, 2.1. These are DISCONTINUED types listed for reference only.

**SHARP-CUTOFF PENTODE**

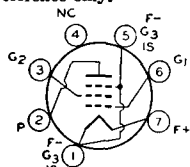

Miniature type used as rf or if amplifier in portable, battery-operated receivers, particularly those not utilizing avc. Outline 11, OUTLINES SECTION. Tube requires miniature seven-

**1L4**

contact socket and may be mounted in any position. Internal shield eliminates need for external bulb shield, but shielding the socket is essential if minimum grid-No.1-to-plate capacitance is required. For typical operation as a resistance-coupled amplifier, refer to Chart 1, RESISTANCE-COUPLED AMPLIFIER SECTION. For filament considerations, refer to type 1U4.

FILAMENT VOLTAGE (DC) .....	1.4	volts
FILAMENT CURRENT .....	0.05	ampere
DIRECT INTERELECTRODE CAPACITANCES:		
Grid No.1 to Plate .....	0.01 max	μf
Grid No.1 to Filament, Grid No.2, Grid No.3, and Internal Shield .....	3.6	μf
Plate to Filament, Grid No.2, Grid No.3, and Internal Shield .....	7.5	μf

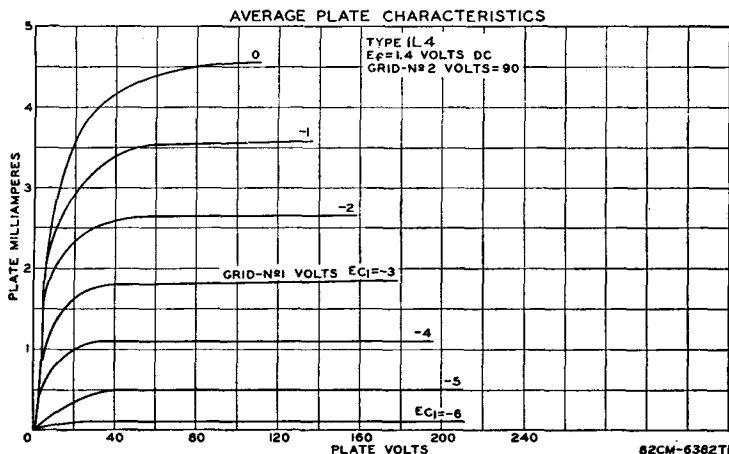

**Maximum Ratings:**
**CLASS A<sub>1</sub> AMPLIFIER**

PLATE VOLTAGE.....	110 <i>max</i>	volts
GRID-NO.2 (SCREEN-GRID) VOLTAGE.....	90 <i>max</i>	volts
GRID-NO.2 SUPPLY VOLTAGE.....	110 <i>max</i>	volts
GRID-NO.1 (CONTROL-GRID) VOLTAGE, Positive Bias Value.....	0 <i>max</i>	volts
TOTAL CATHODE CURRENT.....	6.5 <i>max</i>	ma

**Characteristics:**

Plate Voltage.....	90	90	volts
Grid-No.2 Voltage.....	67.5	90	volts
Grid-No.1 Voltage.....	0	0	volts
Plate Resistance.....	0.6	0.26	megohm
Transconductance.....	925	1025	μmhos
Grid-No.1 Voltage for plate current of 10 μa.....	-6	-10	volts
Plate Current.....	2.9	4.5	ma
Grid-No.2 Current.....	1.2	2.0	ma

## PENTAGRID CONVERTER

Miniature type used in low-drain battery-operated receivers. Outline 11, OUTLINES SECTION. Tube requires miniature seven-contact socket and may be mounted in any position. Filament volts (dc), 1.4; amperes, 0.05. Maximum ratings: plate volts, grid-No.2 volts, and grids-No.3-and-No.5 supply volts, 110 *max*; grids-No.3-and-No.5 volts, 65 *max*; total cathode ma., 4 *max*. This type is used principally for renewal purposes.

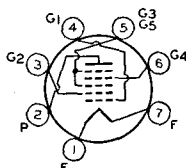

# 1L6

### CONVERTER SERVICE

**Characteristics: (Separate Excitation):**

Plate Voltage.....	90	volts
Grids-No.3-and-No.5 (Screen-Grid) Voltage.....	45	volts
Grid-No.2 (Oscillator-Plate) Voltage.....	90	volts
Grid-No.4 (Mixer-Grid) Voltage.....	0	volts
Grid-No.1 (Oscillator-Grid) Resistor.....	0.2	megohm
Plate Resistance (Approx.).....	0.65	megohm
Plate Current.....	0.5	ma
Grids-No.3-and-No.5 Current.....	0.6	ma
Grid-No.2 Current.....	1.2	ma
Grid-No.1 Current.....	0.035	ma
Total Cathode Current.....	2.35	ma
Conversion Transconductance.....	300	μmhos
Grid-No.4 Voltage for conversion transconductance of 10 μmhos.....	-3.5	volts
Grid-No.4 Voltage for conversion transconductance of 100 μmhos.....	-1.3	volts

**NOTE:** The transconductance between grid No.1 and grid No.2 connected to plate (not oscillating) is approximately 550 μmhos under the following conditions: signal applied to grid No.1 at zero bias; grid No.2 and plate at 90 volts; grids No.3 and No.5 at 45 volts; grid No.4 grounded. Under the same conditions, the plate current is 5 milliamperes, and the amplification factor is 40.

**Maximum Circuit Value (For maximum rated conditions):**

Grid-No.4-Circuit Resistance.....	1.0 <i>max</i>	megohm
-----------------------------------	----------------	--------

## POWER PENTODE

Glass lock-in type used in output stage of battery-operated receivers. Outline 15, OUTLINES SECTION. Tube requires lock-in socket. Filament volts (dc), 1.4; amperes, 0.05. For electrical characteristics and typical operation, refer to glass-octal type 1A5-GT. Type 1LA4 is a DISCONTINUED type listed for reference only.

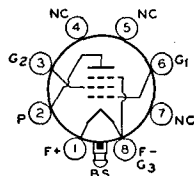

# 1LA4

## PENTAGRID CONVERTER

Glass lock-in type used in battery-operated receivers. Outline 15, OUTLINES SECTION. Tube requires lock-in socket. Filament volts (dc), 1.4; amperes, 0.05. Typical operation as converter is the same as for type 1A7-GT except that the maximum grid-No.2 volts is 65, the maximum total cathode ma. is 4.0, the plate resistance is 0.75 megohm, and the conversion

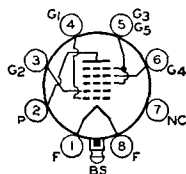

# 1LA6

transconductance for a grid-No.4 (control-grid) bias of -3 volts is 10 μmhos. This type is used principally for renewal purposes.

**POWER PENTODE**

**1LB4**

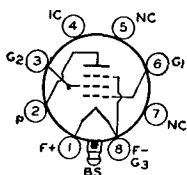

Glass lock-in type used in output stage of battery-operated receivers. Outline 15, OUTLINES SECTION. Tube requires lock-in socket. Filament volts (dc), 1.4; amperes, 0.05. For electrical characteristics, refer to pentode unit of glass-octal type 1D8-GT. Type 1LB4 is used principally for renewal purposes.

**SHARP-CUTOFF PENTODE**

**1LC5**

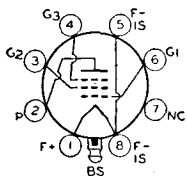

Glass lock-in type used as rf or if amplifier in battery-operated receivers. Outline 15, OUTLINES SECTION. Tube requires lock-in socket. Filament volts (dc), 1.4; amperes, 0.05. Typical operation as class A<sub>1</sub> amplifier: plate volts, 90 (110 max); grid-No.2 (screen-grid) volts, 45 max; grid-No.1 volts, 0; plate resistance (approx.), greater than 1 megohm; transconductance, 775  $\mu$ hos; plate ma., 1.15; grid-No.2 ma., 0.3. This type is used principally for renewal purposes.

**PENTAGRID CONVERTER**

**1LC6**

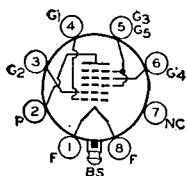

Glass lock-in type used in battery-operated receivers. Outline 15, OUTLINES SECTION. Tube requires lock-in socket. Filament volts (dc), 1.4; amperes, 0.05. Typical operation as converter: plate volts, 90 (110 max); grids-No.3 and-No.5 volts, 35 (45 max); grid-No.2 volts, 45; grid-No.1 volts, 0; plate resistance, 0.65 megohm; plate ma., 0.75; grids-No.3 and-No.5 ma., 0.70; grid-No.2 ma., 1.4; total cathode ma., 2.9; conversion transconductance (zero bias), 275  $\mu$ hos. This type is used principally for renewal purposes.

**DIODE—SHARP-CUTOFF PENTODE**

**1LD5**

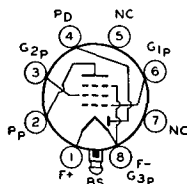

Glass lock-in type used as combined detector and af voltage amplifier in battery-operated receivers. Outline 15, OUTLINES SECTION. Tube requires lock-in socket. Filament volts (dc), 1.4; amperes, 0.05. Characteristics of pentode unit: plate volts, 90 (110 max); grid-No.2 volts, 45; grid-No.1 volts, 0; plate ma., 0.6; grid-No.2 ma., 0.1; plate resistance, 0.75 megohm; transconductance, 575  $\mu$ hos. This type is used principally for renewal purposes.

**MEDIUM-MU TRIODE**

**1LE3**

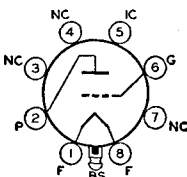

Glass lock-in type used as detector or voltage amplifier in battery-operated receivers. Outline 15, OUTLINES SECTION. Tube requires lock-in socket. Filament volts (dc), 1.4; amperes, 0.05. Typical operation as class A<sub>1</sub> amplifier: plate volts, 90 (110 max); grid volts, -3; plate ma., 1.4; plate resistance, 1900 ohms; transconductance, 760  $\mu$ hos; amplification factor, 14.5. This type is used principally for renewal purposes.

**REMOTE-CUTOFF PENTODE**

**1LG5**

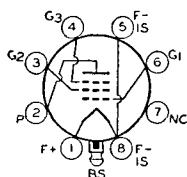

grid-No.2 ma., 0.4; grid-No.1 voltage for transconductance of 10  $\mu$ hos, -10 volts. This type is used principally for renewal purposes.

**DIODE—HIGH-MU TRIODE**

**1LH4**

Glass lock-in type used as combined detector and amplifier in battery-operated receivers. Outline 15, OUTLINES SECTION. Tube requires lock-in socket. Filament volts (dc), 1.4; amperes, 0.05. For electrical characteristics, refer to glass-octal type 1H5-GT. Type 1LH4 is used principally for renewal purposes.

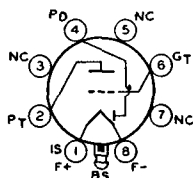

**SHARP-CUTOFF PENTODE**

**1LN5**

Glass lock-in type used as rf or if amplifier in battery-operated receivers. Outline 15, OUTLINES SECTION. Tube requires lock-in socket. Filament volts (dc), 1.4; amperes, 0.05. Typical operation as class A<sub>1</sub> amplifier: plate and grid-No.2 (screen-grid) volts, 90 (110 max); grid-No.1 volts, 0; plate ma., 1.6; grid-No.2 ma., 0.35; plate resistance (approx.), 1.1 megohms; transconductance, 800 μmhos. This type is used principally for renewal purposes.

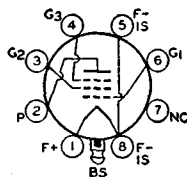

**SHARP-CUTOFF PENTODE**

**1N5-GT**

Glass octal type used as rf or if amplifier in battery-operated receivers. Outline 24, OUTLINES SECTION. Tube requires octal socket and may be mounted in any position. When used

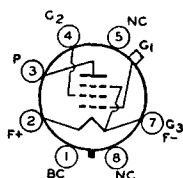

in avc circuits, the 1N5-GT should be only partially controlled to avoid excessive reduction in receiver sensitivity with large signal input.

FILAMENT VOLTAGE (DC).....	1.4	volts
FILAMENT CURRENT.....	0.05	ampere
DIRECT INTERELECTRODE CAPACITANCES:*		
Grid No.1 to Plate.....	0.007 max	μf
Grid No.1 to Filament, Grid No.2, and Grid No.3.....	2.9	μf
Plate to Filament, Grid No.2, and Grid No.3.....	9.0	μf

\* With external shield connected to negative filament terminal.

**Characteristics:**

**CLASS A<sub>1</sub> AMPLIFIER**

Plate Voltage (110 volts max).....	90	volts
Grid-No.2 (Screen-Grid) Voltage (110 volts max).....	90	volts
Grid-No.1 Voltage.....	0	volts
Plate Resistance (Approx.).....	1.5	megohms
Transconductance.....	750	μmhos
Grid-No.1 Voltage (Approx.) for plate current of 10 μa.....	-3.2	volts
Plate Current.....	1.2	ma
Grid-No.2 Current.....	0.3	ma

**DIODE—POWER PENTODE**

**1N6-G**

Glass octal type used as combined detector and power output tube in battery-operated receivers. Maximum over-all length, 4 inches; maximum diameter, 1-3/16 inches. Filament volts (dc), 1.4; amperes, 0.05. Typical operation of pentode unit as class A<sub>1</sub> amplifier: plate and grid-No.2 (screen-grid) volts, 90 (110 max); grid-No.1 volts, -4.5; plate ma., 3.1; grid-No.2 ma. (zero-signal), 0.6; plate resistance (approx.),

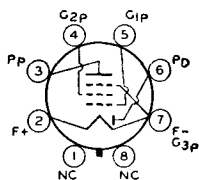

0.3 megohm; transconductance, 800 μmhos; load resistance, 25000 ohms; output watts, 0.1. This is a DISCONTINUED type listed for reference only.

## REMOTE-CUTOFF PENTODE

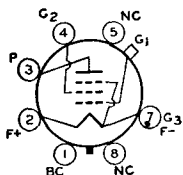

### 1P5-GT

Glass octal type used as rf or if amplifier in battery-operated receivers. Outline 24, OUTLINES SECTION. Tube requires octal socket. Filament volts (dc), 1.4; amperes, 0.05. Typical operation as class A<sub>1</sub> amplifier: plate volts, 90 (110 max); grid-No.2 (screen-grid) volts, 90 (110 max); grid-No.1 volts, 0; plate resistance (approx.), 0.8 megohm; transconductance, 750  $\mu$ mhos; transconductance (approx.) with -12 volts on grid No.1, 10  $\mu$ mhos; plate ma., 2.3; grid-No.2 ma., 0.7. This is a DISCONTINUED type listed for reference only.

## BEAM POWER TUBE

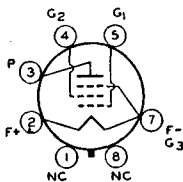

### 1Q5-GT

Glass octal type used in the output stage of battery-operated receivers. Outline 23, OUTLINES SECTION. This type may be supplied with pin No.1 omitted. Tube requires octal socket. Filament volts (dc), 1.4; amperes, 0.1. For electrical characteristics and ratings, refer to type 3Q5-GT with parallel filament arrangement. Type 1Q5-GT is a DISCONTINUED type for reference only.

## PENTAGRID CONVERTER

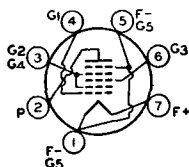

### 1R5

Miniature type used in lightweight, portable, compact, battery-operated receivers. Outline 11, OUTLINES SECTION. Tube requires miniature seven-contact socket and may be mounted in any position. For general discussion of pentagrid types, see *Frequency Conversion* in ELECTRON TUBE APPLICATIONS SECTION. For filament considerations, refer to type 1U4.

any position. For general discussion of pentagrid types, see *Frequency Conversion* in ELECTRON TUBE APPLICATIONS SECTION. For filament considerations, refer to type 1U4.

FILAMENT VOLTAGE (DC) .....	1.4	volts
FILAMENT CURRENT .....	0.05	ampere
<b>DIRECT INTERELECTRODE CAPACITANCES:</b>		
Grid No.3 to All Other Electrodes (RF Input) .....	7.0	$\mu$ f
Plate to All Other Electrodes (Mixer Output) .....	7.5	$\mu$ f
Grid No.1 to All Other Electrodes (Osc. Input) .....	3.8	$\mu$ f
Grid No.3 to Plate .....	0.4 max	$\mu$ f
Grid No.3 to Grid No.1 .....	0.2 max	$\mu$ f
Grid No.1 to Plate .....	0.1 max	$\mu$ f

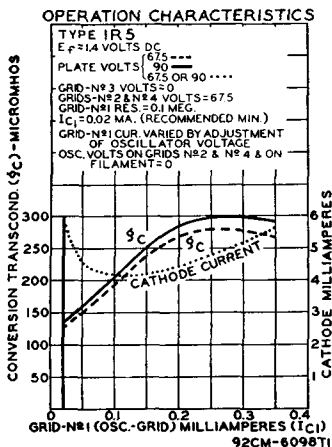

### OPERATION CHARACTERISTICS

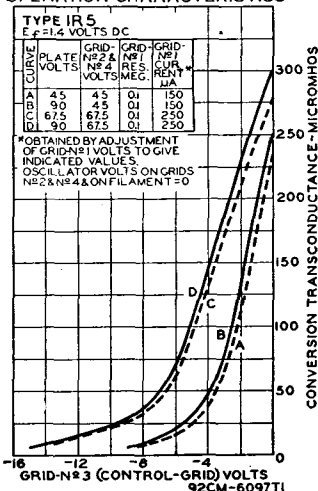

## Maximum Ratings:

PLATE VOLTAGE.....	90 <i>max</i>	volts
GRIDS-NO.2-AND-NO.4 (SCREEN-GRID) VOLTAGE.....	67.5 <i>max</i>	volts
GRIDS-NO.2-AND-NO.4 SUPPLY VOLTAGE.....	90 <i>max</i>	volts
GRID-NO.3 (CONTROL GRID) VOLTAGE, Positive Bias Value.....	0 <i>max</i>	volts
TOTAL ZERO-SIGNAL CATHODE CURRENT.....	5.5 <i>max</i>	ma

## Characteristics:

Plate Voltage.....	45	67.5	90	90	volts
Grids-No.2-and-No.4 Voltage.....	45	67.5	45	67.5	volts
Grid-No.3 Voltage.....	0	0	0	0	volts
Grid-No.1 Resistor.....	0.1	0.1	0.1	0.1	megohm
Plate Resistance (Approx.).....	0.6	0.5	0.8	0.6	megohms
Conversion Transconductance.....	235	280	250	300	μmhos
Grid-No.3 Voltage for conversion trans-conductance of approx. 5 μmhos.....	-9	-14	-9	-14	volts
Plate Current.....	0.7	1.4	0.8	1.6	ma
Grids-No.2-and-No.4 Current.....	1.9	3.2	1.9	3.2	ma
Grid-No.1 Current.....	0.15	0.25	0.15	0.25	ma
Total Cathode Current.....	2.75	5	2.75	5	ma

NOTE: The transconductance between grid No.1 and grids No.2 and No.4 tied to plate (not oscillating) is approximately 1400 μmhos under the following conditions: grids No.1 and No.3 at 0 volts; grids No.2 and No.4 and plate at 67.5 volts.

## POWER PENTODE

Miniature type used in output stage of lightweight, compact, portable, battery-operated equipment. Types 1S4 and 3S4 are identical except for filament arrangement. Outline 11, OUTLINES SECTION. Type 1S4 requires miniature seven-contact socket and may be mounted in any position. For ratings, typical operation, and curves, refer to type 3S4 with parallel filament arrangement. For filament considerations, refer to type 1U4 and ELECTRON TUBE INSTALLATION SECTION.

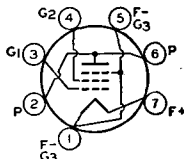

# 1S4

considerations, refer to type 1U4 and ELECTRON TUBE INSTALLATION SECTION. Filament volts (dc), 1.4; amperes, 0.1. This type is used principally for renewal purposes.

## DIODE—

## SHARP-CUTOFF PENTODE

Miniature type used in lightweight, compact, portable, battery-operated receivers as combined detector and af voltage amplifier. Outline 11,

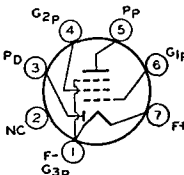

# 1S5

OUTLINES SECTION. Filament volts (dc), 1.4; amperes, 0.05. Tube requires miniature seven-contact socket and may be mounted in any position. For electrical characteristics, curves, and application, refer to type 1U5.

## REMOTE-CUTOFF PENTODE

Miniature type used in lightweight, compact, portable, battery-operated receivers as rf or if amplifier. Because of internal shielding feature, an external bulb shield is not needed,

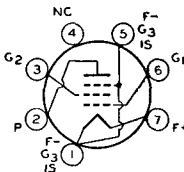

# 1T4

but socket shielding is essential if minimum grid-No.1-to-plate capacitance is to be obtained. Outline 11, OUTLINES SECTION. Tube requires miniature seven-contact socket and may be mounted in any position. For filament considerations, refer to type 1U4.

FILAMENT VOLTAGE (DC).....	1.4	volts
FILAMENT CURRENT.....	0.05	ampere
DIRECT INTERELECTRODE CAPACITANCES:*		
Grid No.1 to Plate.....	0.01 <i>max</i>	μμf
Grid No.1 to Filament, Grid No.2, Grid No.3, and Internal Shield.....	3.6	μμf
Plate to Filament, Grid No.2, Grid No.3, and Internal Shield....	7.5	μμf

\* With close-fitting shield connected to negative filament terminal.



## Maximum Ratings:

Parameter	90 max	volts
PLATE VOLTAGE.....	90	volts
GRID-NO.2 (SCREEN-GRID) VOLTAGE.....	67.5	volts
GRID-NO.2 SUPPLY VOLTAGE.....	90	volts
GRID-NO.1 (CONTROL-GRID) VOLTAGE, Positive Bias Value.....	0	volts
TOTAL CATHODE CURRENT.....	5.5	ma

## CLASS A<sub>1</sub> AMPLIFIER

### Characteristics:

Plate Voltage.....	45	67.5	90	90	volts
Grid-No.2 Voltage.....	45	67.5	45	67.5	volts
Grid-No.1 Voltage.....	0	0	0	0	volts
Plate Resistance (Approx.).....	0.35	0.25	0.8	0.5	megohm
Transconductance.....	700	875	750	900	μmhos
Grid-No.1 Voltage for transconductance of 10 μmhos.....	-10	-16	-10	-16	volts
Plate Current.....	1.7	3.4	1.8	3.5	ma
Grid-No.2 Current.....	0.7	1.5	0.65	1.4	ma

AVERAGE PLATE CHARACTERISTICS

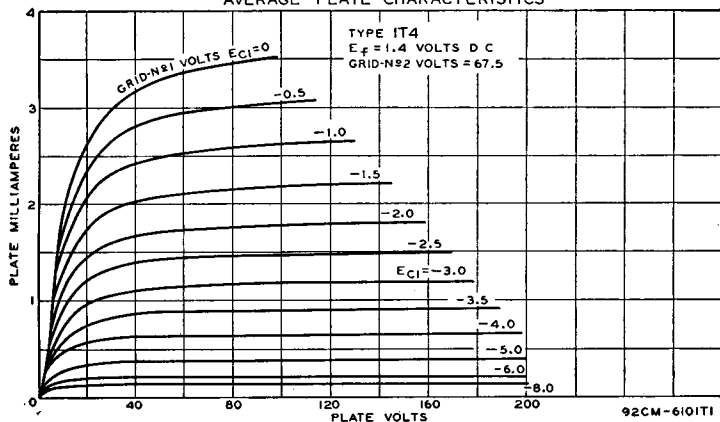

## BEAM POWER TUBE

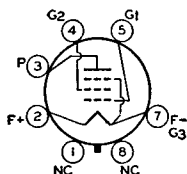

Glass octal type used in output stage of battery-operated receivers. Outline 23, OUTLINES SECTION. This type may be supplied with pin No.1 omitted. Tube requires octal socket. Filament volts (dc), 1.4; amperes, 0.05. For filament considerations, refer to type 1U4. Typical operation as class A<sub>1</sub> amplifier with fixed bias: plate and grid-No.2 (screen-grid) volts, 90 (110 max); grid-No.1 volts, -6; peak af grid-

No.1 volts, 6; plate ma. (maximum or zero-signal), 6.5; grid-No.2 ma. (zero-signal), 0.8; grid-No.2 ma. (maximum signal), 1.5; plate resistance, 0.25 megohm; transconductance, 1150 μmhos; load resistance, 14000 ohms; total harmonic distortion, 7.5 per cent; output watts, 0.17. This is a DISCONTINUED type listed for reference only.

## 1T5-GT

## DIODE—SHARP-CUTOFF PENTODE

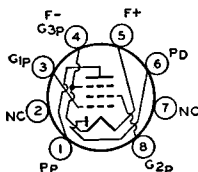

Subminiature type used as combined detector and audio amplifier in small, compact, battery-operated receivers for the standard AM broadcast band. Outline 8, OUTLINES SECTION. Tube requires subminiature eight-contact socket and may be mounted in any position. Base pins should not be soldered to circuit elements because heat of soldering operation may crack the glass seal. Filament volts (dc), 1.25;

amperes, 0.04. The filament may be connected directly across a dry-cell battery rated at a terminal potential of 1.5 volts. Filament voltage should never exceed 1.6 volts. Typical operation of pentode unit

## 1T6

as class A<sub>1</sub> amplifier: plate and grid-No.2 (screen-grid) volts, 67.5 max; grid-No.1 volts, 0; plate resistance (approx.), 0.4 megohm; transconductance, 600 μmhos; plate ma., 1.6; grid-No.2 ma., 0.4; total cathode ma., 2.0 max. Maximum diode plate ma., 0.25. This is a DISCONTINUED type listed for reference only.

## SHARP-CUTOFF PENTODE

# 1U4

Miniature type used as rf or if amplifier in stages not controlled by avc in lightweight, compact, portable, battery-operated equipment. Because the grid No.2 can be operated at the

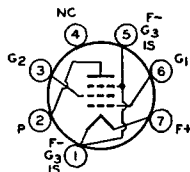

same voltage as the plate, a voltage-dropping resistor is not needed. For typical operation as a resistance-coupled amplifier, refer to Chart 3, RESISTANCE-COUPLED AMPLIFIER SECTION.

FILAMENT VOLTAGE (DC) .....	1.4	volts
FILAMENT CURRENT .....	0.05	ampere
DIRECT INTERELECTRODE CAPACITANCES:*		
Grid No.1 to Plate .....	0.01 max	μμf
Grid No.1 to Filament, Grid No.2, Grid No.3, and Internal Shield .....	3.6	μμf
Plate to Filament, Grid No.2, Grid No.3, and Internal Shield .....	7.5	μμf

\* External shield connected to negative filament terminal.

Maximum Ratings:	CLASS A <sub>1</sub> AMPLIFIER	
PLATE VOLTAGE .....	110 max	volts
GRID-NO.2 (SCREEN-GRID) VOLTAGE .....	110 max	volts
GRID-NO.1 (CONTROL-GRID) VOLTAGE:		
Negative bias value .....	30 max	volts
Positive bias value .....	0 max	volts
TOTAL CATHODE CURRENT .....	6 max	ma

Characteristics:		
Plate Voltage .....	90	volts
Grid-No.2 Voltage .....	90	volts
Grid-No.1 Voltage .....	0	volts
Plate Resistance (Approx.) .....	1.0	megohm
Transconductance .....	900	μmhos
Grid-No.1 Voltage for transconductance of 10 μmhos .....	-4	volts
Plate Current .....	1.6	ma
Grid-No.2 Current .....	0.5	ma

## INSTALLATION AND APPLICATION

Type 1U4 requires a miniature seven-contact socket and may be mounted in any position. Outline 11, OUTLINES SECTION.

The filament power supply may be obtained from dry-cell batteries, from storage batteries, or from a power line. With dry-cell battery supply, the filament may be connected either directly across a battery rated at a terminal potential of 1.5 volts, or in series with the filaments of similar tubes across a power supply consisting of dry cells in series. In either case, the voltage across the filament should not exceed 1.6 volts.

With power-line or storage-battery supply, the filament may be operated in series with the filaments of other tubes of the same filament-current rating. For such operation, design adjustments should be made so that, with tubes of rated characteristics operating with all electrode voltages applied and on a normal line voltage of 117 volts or on a normal storage-battery voltage of 2.0 volts per cell (without a charger) or 2.2 volts per cell (with a charger), the voltage drop across the filament will be maintained within a range of 1.25 to 1.4 volts with a center of 1.3 volts.

In order to meet the recommended conditions for operating filaments in series from dry-battery, storage-battery, or power-line sources, it may be necessary to use shunting resistors across the individual 1.4-volt sections of filament. Refer to ELECTRON TUBE INSTALLATION SECTION for additional filament considerations.

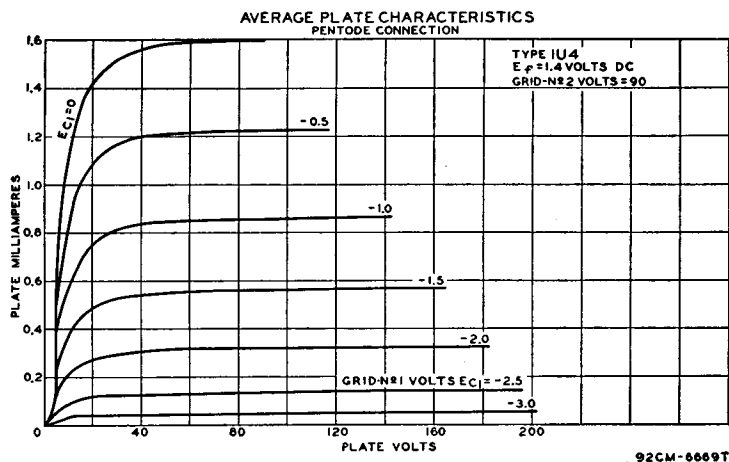

## DIODE—SHARP-CUTOFF PENTODE

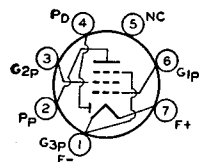

Miniature type used in light-weight, compact, portable, battery-operated receivers as combined detector and af voltage amplifier. The 1U5 is similar to the 1S5 but utilizes an improved structure which greatly reduces any tendency toward microphonic effects.

# 1U5

In addition, the diode unit is effectively shielded from the pentode unit to prevent "play-through." Outline 11, OUTLINES SECTION. Tube requires miniature seven-contact socket and may be mounted in any position. For typical operation as a resistance-coupled amplifier, refer to Chart 2, RESISTANCE-COUPLED AMPLIFIER SECTION. For filament considerations, refer to type 1U4.

FILAMENT VOLTAGE (DC) .....	1.4	volts
FILAMENT CURRENT .....	0.05	ampere

### Maximum Ratings: PENTODE UNIT AS CLASS A<sub>1</sub> AMPLIFIER

PLATE VOLTAGE .....	90 <i>max</i>	volts
GRID-NO.2 (SCREEN-GRID) VOLTAGE .....	90 <i>max</i>	volts
GRID-NO.1 (CONTROL-GRID) VOLTAGE:		
Negative bias value .....	50 <i>max</i>	volts
Positive bias value .....	0 <i>max</i>	volts
TOTAL CATHODE CURRENT .....	8 <i>max</i>	ma

### Characteristics:

Plate Voltage .....	67.5	volts
Grid-No.2 Voltage .....	67.5	volts
Grid-No.1 Voltage .....	0	volts
Plate Resistance .....	0.6	megohm
Transconductance .....	625	$\mu$ hos
Grid-No.1 Voltage for plate current of 10 $\mu$ a .....	-5	volts
Plate Current .....	1.6	ma
Grid-No.2 Current .....	0.4	ma

### DIODE UNIT

Maximum Rating:		
PLATE CURRENT .....	0.25 <i>max</i>	ma

Diode unit is located at negative end of filament and is independent of the pentode except for the common filament.

**AVERAGE PLATE CHARACTERISTICS  
PENTODE UNIT**

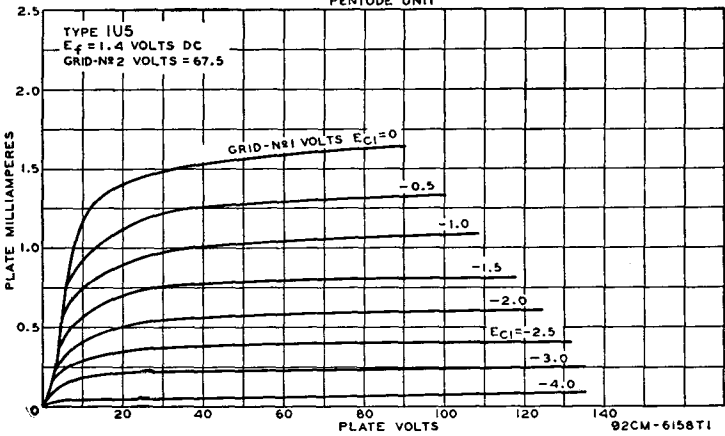

**HALF-WAVE VACUUM RECTIFIER**

Glass type used in ac/dc or automobile receivers. Outline 34 or 35, OUTLINES SECTION. Tube requires four-contact socket. For heater considerations, refer to type 6AT6. Heater volts (ac/dc), 6.3; amperes, 0.3. Maximum ratings as half-wave rectifier: peak inverse plate volts, 1000; peak plate ma., 270; peak heater-cathode volts, 500; dc output ma., 45. This type is used principally for renewal purposes.

**1-v**

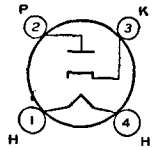

**HALF-WAVE VACUUM RECTIFIER**

Miniature type used in high-voltage, low-current applications such as the rectifier in high-voltage, pulse-operated voltage-doubling power supplies for kinescopes. The very low power

**1V2**

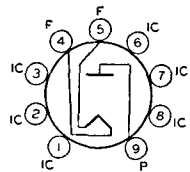

required by the filament permits the use of a rectifier transformer having small size and light weight. For curve of average plate characteristics, see page 64.

FILAMENT VOLTAGE (AC).....	0.625	volt
FILAMENT CURRENT.....	0.3	ampere
DIRECT INTERELECTRODE CAPACITANCE:		
Plate to Filament (Approx.).....	0.8	μf

**PULSED-RECTIFIER SERVICE**

*For operation in a 525-line, 30-frame system*

**Maximum Ratings**

PEAK INVERSE PLATE VOLTAGE.....	7500 max	volt
PEAK PLATE CURRENT.....	10 max	ma
AVERAGE PLATE CURRENT.....	0.5 max	ma

**INSTALLATION AND APPLICATION**

Type 1V2 requires a miniature nine-contact socket and may be mounted in any position. The socket should be made of material having low leakage and should have adequate insulation between its filament and plate terminals to withstand the maximum peak inverse plate voltage. To provide the required insulation in miniature nine-contact sockets designed with a cylindrical center shield, it is necessary

to remove the center shield. In addition, it is recommended that the socket clips for pins 1, 6, and 7 be removed to reduce the possibility of arc-over and minimize leakage. Outline 14, OUTLINES SECTION.

The filament is of the coated type and is designed for operation at 0.625 volt. The filament windings on the pulse transformer should be adjusted to provide the rated voltage under average line-voltage conditions. When the filament voltage is measured, it is recommended that an rms voltmeter of the thermal type be used. The meter and its leads must be insulated to withstand 15000 volts and the stray capacitances to ground should be minimized.

The high voltages at which the 1V2 is operated are very dangerous. Great care should be taken to prevent coming in contact with these high voltages. Particular care against fatal shock should be taken in measuring the filament voltage in those circuits where the filament is not grounded. Precautions must include safeguards which definitely eliminate all hazards to personnel.

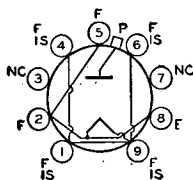

### HALF-WAVE VACUUM RECTIFIER

Miniature types used in high-voltage, low-current applications such as the rectifier in a high-voltage, rf-operated power supply, or as the rectifier of high-voltage pulses produced in television scanning systems. Outlines 16 and 17, respectively, OUTLINES SECTION.

# 1X2-A 1X2-B

Tubes require miniature nine-contact socket and may be mounted in any position. Plate connection is cap at top of bulb. Pins 3 and 7 may be used as tie points for filament dropping resistor and high-voltage filter resistor, or may be connected to the filament. These pins should *not* be connected to low-potential circuits. For other filament and high-voltage considerations, refer to type 1B3-GT. For curve of average plate characteristics, see page 64. Type 1X2-A is used principally for renewal purposes.

FILAMENT VOLTAGE (AC).....	1.25	volts
FILAMENT CURRENT.....	0.2	ampere
DIRECT INTERELECTRODE CAPACITANCE:		
Plate to Filament (Approx.).....	1.0	$\mu$ f

#### PULSED-RECTIFIER SERVICE

*For operation in a 525-line, 30-frame system*

<b>Maximum Ratings:</b>	<i>1X2-A</i>	<i>1X2-B</i>	
PEAK INVERSE PLATE VOLTAGE (Absolute Maximum) <sup>o</sup> .....	18000 max	22000 max	volts
PEAK PLATE CURRENT.....	10 max	45 max	ma
AVERAGE PLATE CURRENT.....	1 max	0.5 max	ma

#### Typical Operation:

<b>Peak Plate Supply Voltage:</b>			
Positive pulse value.....	14000	18000	volts
Negative pulse value.....	3500	2000	volts
DC Output Voltage (Approx.).....	14000	18000	volts
DC Output Current (Approx.).....	175	100	$\mu$ a

<sup>o</sup> The dc component must not exceed 18000 volts.

■ Under no circumstances should this absolute value be exceeded.

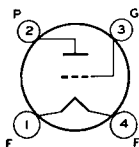

### POWER TRIODE

Glass type used in output stage of radio receivers and amplifiers. As a class A<sub>1</sub> power amplifier, the 2A3 is usable either singly or in push-pull combination.

# 2A3

FILAMENT VOLTAGE (AC/DC).....	2.5	volts
FILAMENT CURRENT.....	2.5	amperes

# RCA Receiving Tube Manual

## DIRECT INTERELECTRODE CAPACITANCES (Approx.):

Grid to Plate.....	16.5	μf
Grid to Filament.....	7.5	μf
Plate to Filament.....	6.5	μf

### Maximum Ratings:

#### CLASS A<sub>1</sub> AMPLIFIER

PLATE VOLTAGE.....	300 max	volts
PLATE DISSIPATION.....	15 max	watts

### Typical Operation:

Plate Voltage.....	250	volts
Grid Voltage*#.....	-45	volts
Plate Current.....	60	ma
Amplification Factor.....	4.2	
Plate Resistance.....	800	ohms
Transconductance.....	5250	μmhos
Load Resistance.....	2500	ohms
Second Harmonic Distortion.....	5	per cent
Power Output.....	3.5	watts

### Maximum Ratings:

#### PUSH-PULL CLASS AB<sub>1</sub> AMPLIFIER

PLATE VOLTAGE.....	300 max	volts
PLATE DISSIPATION.....	15 max	watts

### Typical Operation (Values Are For Two Tubes):

	Fixed Bias	Cathode Bias	
Plate Supply Voltage.....	300	300	volts
Grid Voltage*#.....	-62	-	volts
Cathode-Bias Resistor.....	-	780	ohms
Peak AF Grid-to-Grid Voltage.....	124	156	volts
Zero-Signal Plate Current.....	80	80	ma
Maximum-Signal Plate Current.....	147	100	ma
Effective Load Resistance (Plate-to-plate).....	3000	5000	ohms
Total Harmonic Distortion.....	2.5	5.0	per cent
Power Output.....	15	10	watts

### Maximum Circuit Values:

Grid-Circuit Resistance:		
For fixed-bias operation.....	0.05 max	megohm
For cathode-bias operation.....	0.5 max	megohm

\* Grid voltage referred to mid-point of ac-operated filament.

# When a single 2A3 is operated cathode-biased, the cathode-biasing resistor value should be 750 ohms.

## INSTALLATION AND APPLICATION

Type 2A3 requires a four-contact socket and may be mounted in any position. Outline 52, OUTLINES SECTION. It is especially important that this tube, like other power-handling tubes, be adequately ventilated.

The values recommended for push-pull operation are different from the conventional ones usually given on the basis of characteristics for a single tube. The values shown for Push-Pull Class AB<sub>1</sub> operation cover operation with fixed bias and with cathode bias, and have been determined on the basis of no grid current flow during the most positive swing of the input signal and of cancellation of second-harmonic distortion by virtue of the push-pull circuit. The cathode resistor should preferably be shunted by a suitable filter network to minimize grid-bias variations produced by current surges in the cathode resistor.

When 2A3's are operated in push-pull, it is desirable to provide means for adjusting the bias on each tube independently. This requirement is a result of the very high transconductance of these tubes (5250 micromhos). This very high value makes the 2A3 somewhat critical as to grid-bias voltage, since a very small bias-voltage change produces a very large change in plate current. It is obvious, therefore, that the difference in plate current between two tubes may be sufficient to unbalance the system seriously. To avoid this possibility, simple methods of independent cathode-bias adjustment may be used, such as (1) input transformer with two independent secondary windings, or (2) filament transformer with two independent filament windings. With either of these methods, each tube can be biased separately so as to obtain circuit balance.

## AVERAGE PLATE CHARACTERISTICS

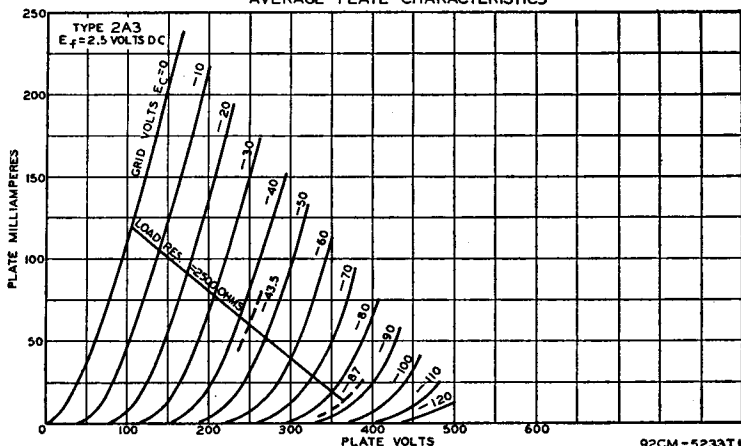

92CM-5233T1

### POWER PENTODE

Glass type used in output stage of ac-operated receivers. Outline 42, OUTLINES SECTION. Tube requires six-contact socket. Except for its heater rating (2.5 volts ac/dc; 1.75 amperes), the 2A5 has electrical characteristics identical with type 6F6. Type 2A5 is a DISCONTINUED type listed for reference only.

**2A5**

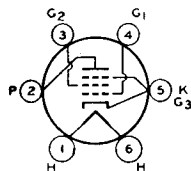

### TWIN DIODE—HIGH-MU TRIODE

Glass type used in ac-operated receivers chiefly as a combined detector, amplifier, and avc tube. Outline 39, OUTLINES SECTION. Tube requires six-contact socket. Except for its heater rating (2.5 volts ac/dc; 0.8 ampere), and within its 250-volt maximum plate rating, the 2A6 has electrical characteristics identical with type 6SQ7. Type 2A6 is a DISCONTINUED type listed for reference only.

**2A6**

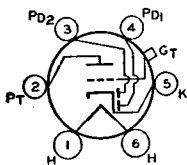

### PENTAGRID CONVERTER

Glass type used in ac-operated receivers. Outline 39, OUTLINES SECTION. Tube requires small seven-contact (0.75-inch, pin-circle diameter) socket. Except for its heater rating (2.5 volts ac/dc; 0.8 ampere) and its interelectrode capacitances, the 2A7 has electrical characteristics identical with type 6A8. Complete shielding of this tube is generally necessary. Type 2A7 is a DISCONTINUED type listed for reference only.

**2A7**

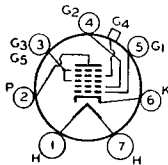

### MEDIUM-MU TRIODE

Miniature type used as local oscillator in uhf television receivers employing series-connected heater strings. Outline 9, OUTLINES SECTION. Heater volts (ac/dc), 2.35; amperes,

**2AF4-A**

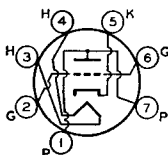

0.6; warm-up time (average), 11 seconds. For definition of heater warm-up time and method for determining it, see type 6CG7. Except for heater rating, type 2AF4-A is identical with miniature type 6AF4-A.

**TWIN DIODE—  
REMOTE-CUTOFF PENTODE**

**2B7**

Glass type used as combined detector, avc tube, and amplifier. Outline 39, OUTLINES SECTION. Tube requires small seven-contact (0.75-inch, pin-circle diameter) socket. Except for its heater rating (2.5 volts ac/dc; 0.8 ampere) and its interelectrode capacitances, the 2B7 has electrical characteristics identical with type 6B8-G. Type 2B7 is a DISCONTINUED type listed for reference only.

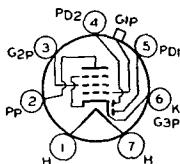

**MEDIUM-MU TRIODE**

**2BN4**

Miniature type used as rf amplifier in grid-drive circuits of vhf television tuners employing series-connected heater strings. Outline 11, OUTLINES SECTION. Heater volts

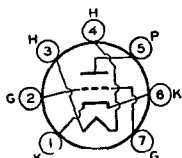

(ac/dc), 2.3; amperes, 0.6; warm-up time (average), 11 seconds. For definition of heater warm-up time and method for determining it, see type 6CG7. Except for heater rating, type 2BN4 is identical with miniature type 6BN4.

**ELECTRON-RAY TUBE**

**2E5**

Glass type used to indicate visually by means of a fluorescent target the effects of a change in a controlling voltage. It is used as a convenient means of indicating accurate radio receiver tuning. Outline 34 or 35, OUTLINES SECTION. Tube requires six-contact socket. Except for its heater rating (2.5 volts ac/dc; 0.8 ampere), the 2E5 has electrical characteristics identical with type 6E5. Type 2E5 is a DISCONTINUED type listed for reference only.

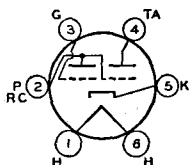

**HALF-WAVE VACUUM RECTIFIER**

**3A2**

Miniature type used as rectifier of high-voltage pulses produced in the scanning systems of color television receivers. Outline 16, OUTLINES SECTION. Tube requires miniature

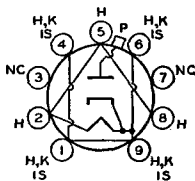

nine-contact socket and may be mounted in any position. For curve of average plate characteristics, see page 64. For high-voltage considerations, see type 1B3-GT.

HEATER VOLTAGE (AC).....	3.15	volts
HEATER CURRENT.....	0.22	ampere
DIRECT INTERELECTRODE CAPACITANCE (Approx.):		
Plate to Heater, Cathode, and Internal Shield.....	1.0	μf

**PULSED-RECTIFIER SERVICE**

<b>Maximum Ratings:</b>	<i>For operation in a 525-line, 30-frame system</i>	
PEAK INVERSE PLATE VOLTAGE.....	18000 max	volts
PEAK PLATE CURRENT.....	80 max	ma
AVERAGE PLATE CURRENT.....	1.5 max	ma

**HALF-WAVE VACUUM RECTIFIER**

**3A3**

Glass octal type used as rectifier of high-voltage pulses produced in the scanning systems of color television receivers. Outline 32, OUTLINES SECTION. Tube requires octal socket

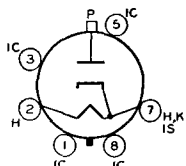

and may be mounted in any position. For curve of average plate characteristics, see page 64. For high-voltage considerations, see type 1B3-GT.



HEATER VOLTAGE (AC) .....	3.15	volts
HEATER CURRENT .....	0.22	ampere
DIRECT INTERELECTRODE CAPACITANCE (Approx.):		
Plate to Heater, Cathode, and Internal Shield .....	1.5	$\mu$ f

### PULSED-RECTIFIER SERVICE

<i>For operation in a 525-line, 30-frame system</i>		
PEAK INVERSE PLATE VOLTAGE .....	30000 max	volts
PEAK PLATE CURRENT .....	80 max	ma
AVERAGE PLATE CURRENT .....	1.5 max	ma

### DIODE—TRIODE—PENTODE

Glass octal type used as combined detector, af amplifier, and rf amplifier in battery-operated receivers. Maximum over-all length, 3-7/16 inches; maximum diameter, 1-5/16 inches. Filament has mid-tap so that tube may be used with either 1.4- or 2.8-volt dc filament supplies. Filament volts, 1.4 (parallel), 2.8 (series); amperes, 0.1 (parallel), 0.05 (series). Typical operation of triode unit as class A<sub>1</sub> amplifier: plate

volts, 90 (110 max); grid volts, 0; amplification factor, 65; plate resistance, 0.2 megohm; transconductance, 325  $\mu$ mhos; plate ma., 0.2. Typical operation of pentode unit as class A<sub>1</sub> amplifier: plate volts, 90 (110 max); grid-No.2 volts, 90 (110 max); grid-No.1 volts, 0; plate resistance, 0.8 megohm; transconductance, 750  $\mu$ mhos; plate ma., 1.5; grid-No.2 ma., 0.5. This is a DISCONTINUED type listed for reference only.

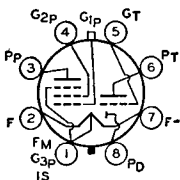

## 3A8-GT

### TWIN DIODE

Miniature type having high permeance used as detector in television receivers employing series-connected heater strings. Each diode section can be used independently of the other, or

the two sections can be combined in parallel or full-wave arrangement. Resonant frequency of each unit is approximately 700 megacycles per second. Outline 9, OUTLINES SECTION. Heater volts (ac/dc), 3.15; amperes, 0.6; warm-up time (average), 11 seconds. For definition of heater warm-up time and method for determining it, see type 6CG7. Except for heater rating, type 3AL5 is identical with miniature type 6AL5.

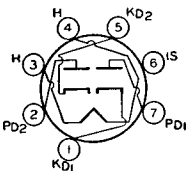

## 3AL5

### SHARP-CUTOFF PENTODE

Miniature type used as rf amplifier in television receivers employing series-connected heater strings. Outline 11, OUTLINES SECTION.

Heater volts (ac/dc), 3.15; amperes, 0.6; warm-up time (average), 11 seconds. For definition of heater warm-up time and method for determining it, see type 6CG7. Peak heater-cathode volts, 200 max. When the heater is positive with respect to the cathode, the dc component of the heater-cathode voltage must not exceed 100 volts. Except for heater and heater-cathode ratings, type 3AU6 is identical with miniature type 6AU6.

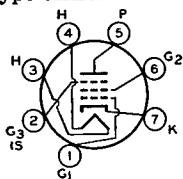

## 3AU6

### TWIN DIODE—HIGH-MU TRIODE

Miniature type used as combined detector, amplifier, and avc tube in television receivers employing series-connected heater strings. Outline 11, OUTLINES SECTION. Heater volts

(ac/dc), 3.15; amperes, 0.6; warm-up time (average), 11 seconds. For definition of heater warm-up time and method for determining it, see type 6CG7. Peak heater-

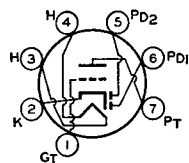

## 3AV6

cathode volts, 200 *max.* When the heater is positive with respect to the cathode, the dc component of the heater-cathode voltage must not exceed 100 volts. Except for heater and heater-cathode rating, type 3AV6 is identical with miniature type 6AV6.

**HALF-WAVE VACUUM RECTIFIER**

**3B2**

Glass octal type used as rectifier of high-voltage pulses produced in the scanning systems of television receivers. Outline 47, OUTLINES SECTION. Tube requires octal socket and may be

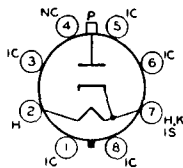

mounted in any position. For curve of average plate characteristics, see page 64. For high-voltage considerations, see type 1B3-GT.

HEATER VOLTAGE (AC/DC) .....	3.15	volts
HEATER CURRENT .....	0.22	ampere
DIRECT INTERELECTRODE CAPACITANCE (Approx.):		
Plate to Heater, Cathode, and Internal Shield .....	1.8	$\mu$ f

**PULSED-RECTIFIER SERVICE**

*For operation in a 525-line, 30-frame system*

**Maximum Ratings:**

PEAK INVERSE PLATE VOLTAGE (Absolute Maximum) .....	35000†	<i>max</i>	volts
PEAK PLATE CURRENT .....	80	<i>max</i>	ma
AVERAGE PLATE CURRENT .....	1.1	<i>max</i>	ma

†Under no circumstances should this absolute value be exceeded.

**SHARP-CUTOFF PENTODE**

**3BC5**

Miniature type used as rf or if amplifier in television receivers employing series-connected heater strings. Outline 11, OUTLINES SECTION. Heater volts (ac/dc), 3.15; amperes,

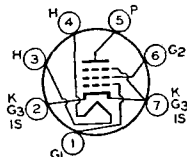

0.6; warm-up time (average), 11 seconds. For definition of heater warm-up time and method for determining it, see type 6CG7. Peak heater-cathode volts, 200 *max.* When the heater is positive with respect to the cathode, the dc component of the heater-cathode voltage must not exceed 100 volts. Except for heater and heater-cathode rating, type 3BC5 is identical with miniature type 6BC5.

**BEAM PENTODE**

**3BN6**

Miniature type used as combined limiter, discriminator, and af voltage amplifier in intercarrier television and FM receivers employing series-connected heater strings. Outline 13,

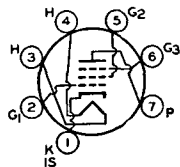

OUTLINES SECTION. Heater volts (ac/dc), 3.15; amperes, 0.6; warm-up time (average), 11 seconds. For definition of heater warm-up time and method for determining it, see type 6CG7. Peak heater-cathode volts, 200 *max.* When the heater is positive with respect to the cathode, the dc component of the heater-cathode voltage must not exceed 100 volts. Except for heater and heater-cathode ratings, type 3BN6 is identical with miniature type 6BN6.

**PENTAGRID AMPLIFIER**

**3BY6**

Miniature type used as gated amplifier in television receivers employing series-connected heater strings. In such service, it may be used as a combined sync separator and sync clip-

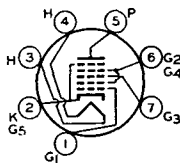

per. Outline 11, OUTLINES SECTION. Heater volts (ac/dc), 3.15; amperes, 0.6; warm-up time (average), 11 seconds. For definition of heater warm-up time and

method for determining it, see type 6CG7. Except for heater rating, type 3BY6 is identical with miniature type 6BY6.

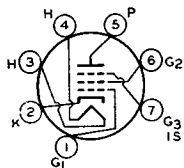

**SEMIREMOTE-CUTOFF PENTODE**

**3BZ6**

Miniature type used in gain-controlled video if stages of television receivers employing series-connected heater strings. Outline 11, OUTLINES SECTION. Heater volts (ac/dc), 3.15;

amperes, 0.6; warm-up time (average), 11 seconds. For definition of heater warm-up time and method for determining it, see type 6CG7. Except for heater rating, type 3BZ6 is identical with miniature type 6BZ6.

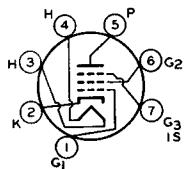

**SHARP-CUTOFF PENTODE**

**3CB6**

Miniature type used as rf or if amplifier in television receivers employing series-connected heater strings. This tube features very high transconductance combined with low interelectrode

capacitance values, and is provided with separate base pins for grid No.3 and cathode to permit the use of an unbypassed cathode resistor to minimize the effects of regeneration. Outline 11, OUTLINES SECTION. Heater volts (ac/dc), 3.15; amperes, 0.6; warm-up time (average), 11 seconds. For definition of heater warm-up time and method for determining it, see type 6CG7. Peak heater-cathode volts: heater negative with respect to cathode, 300 *max*; heater positive with respect to cathode, 200 *max* (the dc component must not exceed 100 volts). Except for heater and heater-cathode rating, type 3CB6 is identical with miniature type 6CB6.

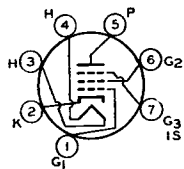

**SHARP-CUTOFF PENTODE**

**3CF6**

Miniature type used as rf or if amplifier in television receivers employing series-connected heater strings. Because of its plate-current cutoff characteristic, this type is used in gain-controlled

stages of video if amplifiers. Outline 11, OUTLINES SECTION. Tube requires miniature seven-contact socket and may be mounted in any position. Heater volts (ac/dc), 3.15; amperes, 0.6; warm-up time (average), 11 seconds. For definition of heater warm-up time and method for determining it, see type 6CG7. Peak heater-cathode volts: heater negative with respect to cathode, 300 *max*; heater positive with respect to cathode, 200 *max* (the dc component must not exceed 100 volts). Except for heater and heater-cathode ratings, type 3CF6 is identical with miniature type 6CF6.

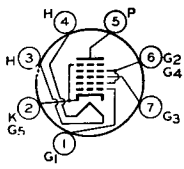

**PENTAGRID AMPLIFIER**

**3CS6**

Miniature type used as gated amplifier in television receivers employing series-connected heater strings. In such service, it may be used as a combined sync separator and sync clipper. Outline 11, OUTLINES SECTION. Heater volts (ac/dc), 3.15; amperes, 0.6; warm-up

time (average), 11 seconds. For definition of heater warm-up time and method for determining it, refer to type 6CG7. Except for heater ratings, type 3CS6 is identical with miniature type 6CS6.

### 3DT6

#### SHARP-CUTOFF PENTODE

Miniature type used as FM detector in television receivers employing series-connected heater strings. Outline 11, OUTLINES SECTION. Heater volts (ac/dc), 3.15; amperes, 0.6;

warm-up time (average), 11 seconds. For definition of heater warm-up time and method for determining it, see type 6CG7. Except for heater rating, type 3DT6 is identical with miniature type 6DT6.

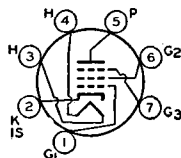

### 3LF4

#### BEAM POWER TUBE

Glass lock-in type used in output stage of ac/dc/battery portable receivers. Outline 15, OUTLINES SECTION. Tube requires lock-in socket. Filament volts (dc), 1.4 (parallel), 2.8 (series); amperes, 0.1 (parallel), 0.05 (series). For electrical characteristics, refer to glass-octal type 3Q5-GT. Type 3LF4 is used principally for renewal purposes.

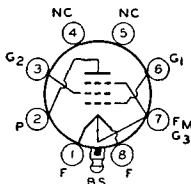

### 3Q4

#### POWER PENTODE

Miniature type used in output stage of lightweight, compact, portable, battery-operated equipment. Outline 11, OUTLINES SECTION. Except for terminal connections, types 3Q4 and

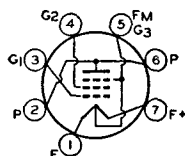

3V4 are identical. Refer to type 3V4 for ratings, typical operation, curves, and installation considerations.

### 3Q5-GT

#### BEAM POWER TUBE

Glass octal type used in output stage of ac/dc/battery portable receivers. Outline 22 or 23, OUTLINE SECTION. This type may be supplied with pin No.1 omitted. Tube requires

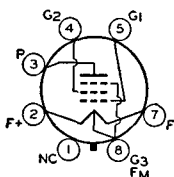

octal socket and may be mounted in any position. For series filament arrangement, filament voltage is applied between pins 2 and 7. For parallel filament arrangement, filament voltage is applied between pin 8 and pins 2 and 7 connected together. For additional filament considerations, refer to type 3V4 and ELECTRON TUBE INSTALLATION SECTION.

Filament Arrangement	Series	Parallel	
FILAMENT VOLTAGE (DC).....	2.8	1.4	volts
FILAMENT CURRENT.....	0.05	0.1	ampere

#### CLASS A<sub>1</sub> AMPLIFIER

Maximum Ratings:	Series	Parallel	
PLATE VOLTAGE.....	110 max	110 max	volts
GRID-NO. 2 (SCREEN-GRID) VOLTAGE.....	110 max	110 max	volts
TOTAL ZERO-SIGNAL CATHODE CURRENT...	6* max	12 max	ma

\*For each 1.4-volt filament section.

Typical Operation:	Series		Parallel			
Plate Voltage.....	90	110	85	90	110	volts
Grid-No. 2 Voltage.....	90	110	85	90	110	volts
Grid-No. 1 Voltage.....	-4.5	-6.6	-5	-4.5	-6.6	volts
Peak AF Grid-No. 1 Voltage.....	4.5	5.1	5	4.5	5.4	volts
Plate Current.....	8.0	8.5	7.0	9.5	10	ma
Grid-No. 2 Current (Approx.).....	1.0	1.1	0.8	1.3	1.4	ma

Plate Resistance (Approx.)	0.08	0.11	0.07	0.09	0.1	megohms
Transconductance	2000	2000	1950	2200	2200	μmhos
Load Resistance	8000	8000	9000	8000	8000	ohms
Total Harmonic Distortion	8.5	8.5	5.5	6.0	6.0	per cent
Maximum-Signal Power Output	230	330	250	270	400	mw

**Maximum Circuit Values (For maximum rated conditions):**

Grid-No.1-Circuit Resistance:

For fixed-bias operation	2.2 max megohms
For cathode-bias operation	2.2 max megohms

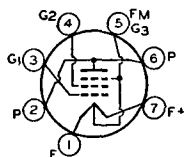

## POWER PENTODE

Miniature type used in output stage of lightweight, compact, portable, battery-operated equipment. Outline 11, OUTLINES SECTION. Tube requires miniature seven-contact socket

# 3S4

and may be mounted in any position. Types 3S4 and 1S4 are identical except for filament arrangement. Type 3S4 features a filament mid-tap so that tube may be used either with a 1.4-volt battery supply or in series with other miniature tubes having 0.050-ampere filaments. For filament considerations, refer to type 3V4 and ELECTRON TUBE INSTALLATION SECTION.

**Filament Arrangement**

	Series	Parallel	
FILAMENT VOLTAGE (DC)	2.8	1.4	volts
FILAMENT CURRENT	0.05	0.1	ampere

### CLASS A<sub>1</sub> AMPLIFIER

**Maximum Ratings:**

	Series	Parallel	
PLATE VOLTAGE	90 max	90 max	volts
GRID-NO.2 (SCREEN-GRID) VOLTAGE	67.5 max	67.5 max	volts
MAXIMUM-SIGNAL CATHODE CURRENT	6* max	12 max	ma
ZERO-SIGNAL CATHODE CURRENT	4.5* max	9 max	ma

\* For each 1.4-volt filament section.

**Typical Operation:**

	Series		Parallel		
Plate Voltage	67.5	90	67.5	90	volts
Grid-No. 2 Voltage	67.5	67.5	67.5	67.5	volts
Grid-No. 1 (Control-Grid) Voltage	-7	-7	-7	-7	volts
Peak AF Grid-No. 1 Voltage	7	7	7	7	volts
Zero-Signal Plate Current	6.0	6.1	7.2	7.4	ma
Zero-Signal Grid-No. 2 Current	1.2	1.1	1.5	1.4	ma

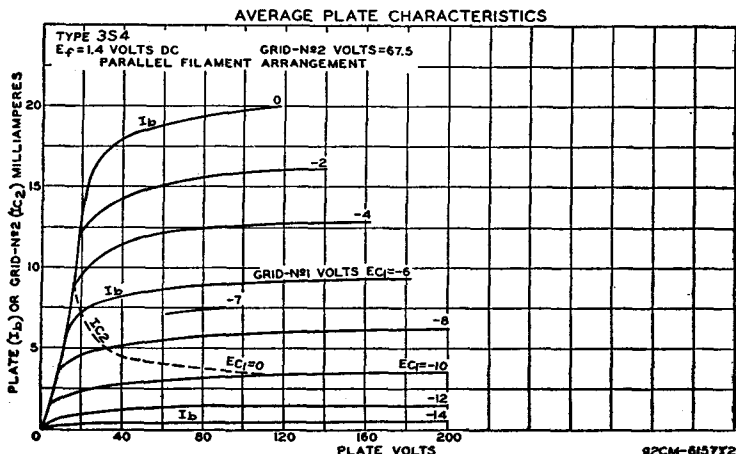

Plate Resistance.....	0.1	0.1	0.1	0.1	megohm
Transconductance.....	1400	1425	1550	1575	μmhos
Load Resistance.....	5000	8000	5000	8000	ohms
Total Harmonic Distortion.....	12	13	10	12	per cent
Maximum-Signal Power Output.....	160	235	180	270	mw

Maximum Circuit Values: (For maximum rated conditions):

Grid-No.1-Circuit Resistance:	
For fixed-bias operation.....	2.2 max megohms
For cathode-bias operation.....	2.2 max megohms

## POWER PENTODE

# 3V4

Miniature type used in output stage of lightweight, compact, portable, battery-operated equipment. Except for terminal connections, types 3V4 and 3Q4 are identical. Both feature

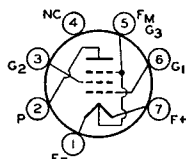

filament mid-tap so that tubes may be used either with a 1.4-volt battery supply or in series with other miniature tubes having 0.050-ampere filaments.

Filament Arrangement	Series	Parallel	
FILAMENT VOLTAGE (DC).....	2.8	1.4	volts
FILAMENT CURRENT.....	0.05	0.1	ampere
DIRECT INTERELECTRODE CAPACITANCES (Approx.):			
Grid No. 1 to Plate.....	0.2		μf
Grid No.1 to Filament, Grid No.2, and Grid No.3.....	5.5		μf
Plate to Filament, Grid No.2, and Grid No.3.....	3.8		μf

## CLASS A<sub>1</sub> AMPLIFIER

Maximum Ratings:	Series	Parallel	
PLATE VOLTAGE.....	90 max	90 max	volts
GRID-NO. 2 (SCREEN-GRID) VOLTAGE.....	90 max	90 max	volts
TOTAL CATHODE CURRENT.....	6 # max	12 max	ma

# For each 1.4-volt filament section.

Typical Operation:	Series	Parallel	
Plate Voltage.....	90	85 90	volts
Grid-No. 2 Voltage.....	90	85 90	volts
Grid-No. 1 (Control-Grid) Voltage.....	-4.5	-5 -4.5	volts
Peak AF Grid-No. 1 Voltage.....	4.5	5 4.5	volts
Zero-Signal Plate Current.....	7.7	6.9 9.5	ma
Zero-Signal Grid-No. 2 Current.....	1.7	1.5 2.1	ma
Plate Resistance (Approx.).....	0.12	0.12 0.1	megohm
Transconductance.....	2000	1975 2150	μmhos
Load Resistance.....	10000	10000 10000	ohms
Total Harmonic Distortion.....	7	10 7	per cent
Maximum-Signal Power Output.....	240	250 270	mw

Maximum Circuit Values (For maximum rated conditions):

Grid-No.1-Circuit Resistance:	
For fixed-bias operation.....	2.2 max megohms
For cathode-bias operation.....	2.2 max megohms

## INSTALLATION AND APPLICATION

Type 3V4 requires miniature seven-contact socket and may be mounted in any position. Outline 11, OUTLINES SECTION.

The filament power supply may be obtained from dry-cell batteries, from storage batteries, or from a power line. With dry-cell battery supply, the filament may be connected either directly across a battery rated at a terminal potential of 1.5 volts, or in series with the filaments of similar tubes across a power supply consisting of dry cells in series. In any case, the voltage across each 1.4-volt section of filament should not exceed 1.6 volts.

With power-line or storage-battery supply, the filament may be operated in series with the filaments of other tubes of the same filament-current rating. For such operation, design adjustments should be made so that, with tubes of rated characteristics operating with all electrode voltages applied and on a normal line voltage of 117 volts or on a normal storage-battery voltage of 2.0 volts per cell (without a charger) or 2.2 volts per cell (with a charger), the voltage drop across each 1.4-volt section of filament will be maintained within a range of 1.25 to 1.4 volts with a center of 1.3 volts.

For series operation of the sections, a shunting resistor must be connected across the section between the F- and  $F_m$ , the filament mid-tap, to bypass any cathode current in this section which is in excess of the rated maximum per section. When other tubes in a series-filament arrangement contribute to the filament current of the 3V4, an additional shunting resistor may be required across the entire filament (F- to F+).

For series filament arrangement, filament voltage is applied between pins No.1 and No.7. For parallel filament arrangement, filament voltage is applied between pin No.5 and pins No.1 and No.7 connected together. Refer to ELECTRON TUBE INSTALLATION SECTION for additional filament considerations.

In series filament arrangement, the grid-No.1 voltage is referred to F-. In parallel filament arrangement, the grid-No.1 voltage is referred to  $F_m$ , the filament mid-tap.

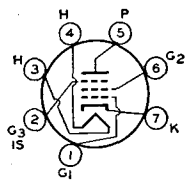
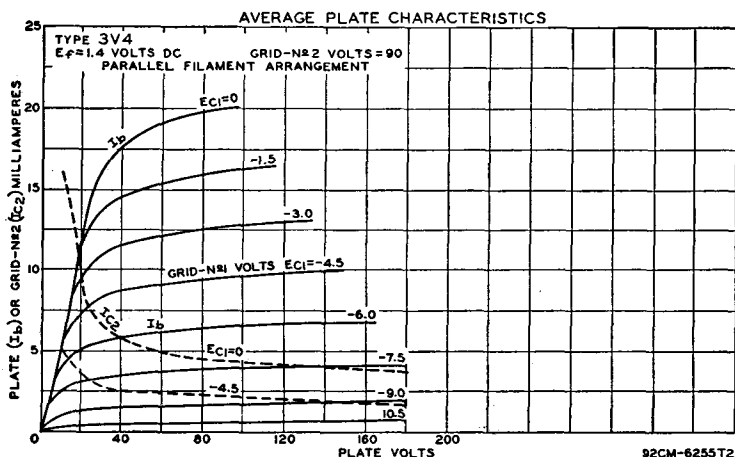

## SHARP-CUTOFF PENTODE

# 4AU6

Miniature type used as rf amplifier in television receivers employing series-connected heater strings. Outline 11, OUTLINES SECTION. Heater volts (ac/dc), 4.2; amperes, 0.45;

warm-up time (average), 11 seconds. For identification of heater warm-up time and method for determining it, see type 6CG7. Peak heater-cathode volts: heater negative with respect to cathode, 300 *max* (the dc component must not exceed 200 volts); heater positive with respect to cathode, 200 *max* (the dc component must not exceed 100 volts). Except for heater and heater-cathode ratings, type 4AU6 is identical with miniature type 6AU6.

## 4BC8

### MEDIUM-MU TWIN TRIODE

Miniature type used in cascode-type circuits of vhf television tuners employing series-connected heater strings. Outline 12, OUTLINES SECTION.

Heater volts (ac/dc), 4.2; amperes, 0.6; warm-up time (average), 11 seconds. For definition of heater warm-up time and method for determining it, see type 6CG7. Except for heater rating, type 4BC8 is identical with miniature type 6BC8.

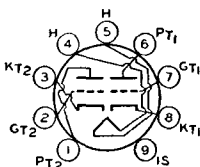

## 4BQ7-A

### MEDIUM-MU TWIN TRIODE

Miniature type used as rf or if amplifier in television receivers employing series-connected heater strings. This type is especially useful in the rf stage of television receivers utilizing a cathode-

drive amplifier of the direct-coupled type or in push-pull cathode-drive rf amplifiers. Outline 12, OUTLINES SECTION. Heater volts (ac/dc), 4.2; amperes, 0.6; warm-up time (average), 11 seconds. For definition of heater warm-up time and method for determining it, see type 6CG7. Except for heater rating, the 4BQ7-A is identical with miniature type 6BQ7-A.

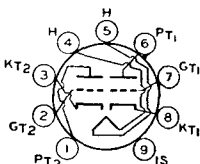

## 4BZ7

### MEDIUM-MU TWIN TRIODE

Miniature type used as rf or if amplifier in television receivers employing series-connected heater strings. This type is especially useful in the rf stage of television receivers utilizing a cathode-

drive amplifier of the direct-coupled type or in push-pull cathode-drive rf amplifiers. Outline 12, OUTLINES SECTION. Heater volts (ac/dc), 4.2; amperes, 0.6; warm-up time (average), 11 seconds. For definition of heater warm-up time and method for determining it, see type 6CG7. Except for heater rating, type 4BZ7 is identical with miniature type 6BZ7.

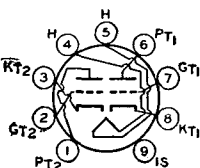

## 4CB6

### SHARP-CUTOFF PENTODE

Miniature type used as if and as rf amplifier in television receivers employing series-connected heater strings. Outline 11, OUTLINES SECTION. Heater volts (ac/dc), 4.2; amperes,

0.45; warm-up time (average), 11 seconds. For definition of heater warm-up time and method for determining it, see type 6CG7. Except for heater rating, type 4CB6 is identical with miniature type 6CB6.

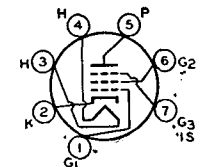

## 4DT6

### SHARP-CUTOFF PENTODE

Miniature type used as FM detector in television receivers employing series-connected heater strings. Outline 11, OUTLINES SECTION. Heater volts (ac/dc), 4.2; amperes, 0.45;

warm-up time (average), 11 seconds. For definition of heater warm-up time and method for determining it, see type 6CG7. Except for heater rating, type 4DT6 is identical with miniature type 6DT6.

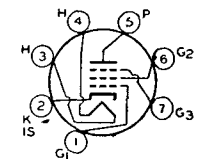



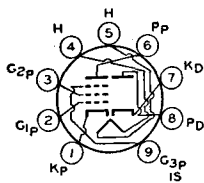

**DIODE—SHARP-CUTOFF  
PENTODE**

**5AM8**

Miniature type used in diversified applications in television receivers employing series-connected heater strings. The pentode unit is used as an if amplifier, video amplifier, or age amplifier.

The high-perveance diode is used as an audio detector, video detector, or dc restorer. Outline 12, OUTLINES SECTION. Heater volts (ac/dc), 4.7; amperes, 0.6; warm-up time (average), 11 seconds. For definition of heater warm-up time and method for determining it, see type 6CG7. Except for heater rating, type 5AM8 is identical with miniature type 6AM8.

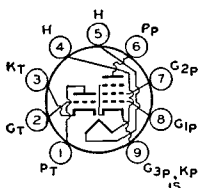

**MEDIUM-MU TRIODE—  
SHARP-CUTOFF PENTODE**

**5AN8**

Miniature type used in a wide variety of applications in television receivers employing series-connected heater strings. The pentode unit is used as an if amplifier, a video amplifier, an

age amplifier, or a reactance tube. The triode unit is used in low-frequency oscillator, sync-separator, sync-clipper, and phase-splitter circuits. Outline 12, OUTLINES SECTION. Heater volts (ac/dc), 4.7; amperes, 0.6; warm-up time (average), 11 seconds. For definition of heater warm-up time and method for determining it, see type 6CG7. Except for heater rating, type 5AN8 is identical with miniature type 6AN8.

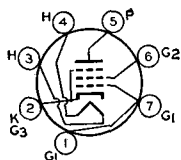

**BEAM POWER TUBE**

**5AQ5**

Miniature type used as audio amplifier in television receivers employing series-connected heater strings. Outline 13, OUTLINES SECTION. Heater volts (ac/dc), 4.7; amperes, 0.6;

warm-up time (average), 11 seconds. For definition of heater warm-up time and method for determining it, see type 6CG7. Peak heater-cathode volts, 200 max. When the heater is positive with respect to the cathode, the dc component of the heater-cathode voltage must not exceed 100 volts. Except for heater and heater-cathode rating, type 5AQ5 is identical with miniature type 6AQ5.

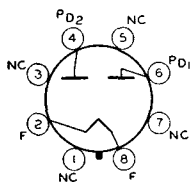

**FULL-WAVE VACUUM RECTIFIER**

**5AS4**

Glass octal type used in power supply of television receivers having high dc requirements. Outline 47, OUTLINES SECTION. Tube requires octal socket. Vertical mounting is preferred, but horizontal mounting is permissible if pins 1 and 4 are in vertical plane. It is especially important that this tube, like other power-handling tubes, be adequately ventilated. Heater volts (ac), 5.0; amperes, 3.0. For maximum ratings, typical operation, and curves, refer to type 5U4-GB.

**DIODE—SHARP-CUTOFF  
PENTODE**

**5AS8**

Miniature type used in diversified applications in television receivers employing series-connected heater strings. The pentode unit is used as an if amplifier, video amplifier, or agc amplifier.

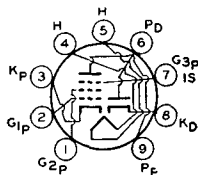

The high-perveance diode is used as an audio detector, video detector, or dc restorer. Outline 12, OUTLINES SECTION. Heater volts (ac/dc), 4.7; amperes, 0.6; warm-up time (average), 11 seconds. For definition of heater warm-up time and method for determining it, see type 6CG7. Except for heater rating, type 5AS8 is identical with miniature type 6AS8.

**TRIODE—PENTODE CONVERTER**

**5AT8**

Miniature type used as combined oscillator and mixer tube in television receivers employing series-connected heater strings. Outline 12, OUTLINES SECTION. The basing arrangement of

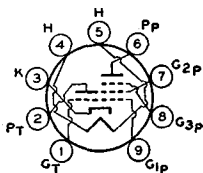

this type is particularly suitable for connection to the coils of certain designs of turret tuners. Heater volts (ac/dc), 4.7; amperes, 0.6; warm-up time (average), 11 seconds. For definition of heater warm-up time and method for determining it, see type 6CG7. Peak heater-cathode volts, 200 max. When the heater is positive with respect to the cathode, the dc component of the heater-cathode voltage must not exceed 100 volts. Except for heater and heater-cathode ratings, type 5AT8 is identical with miniature type 6AT8.

**MEDIUM-MU TRIODE—  
SHARP-CUTOFF PENTODE**

**5AV8**

Miniature type used in a wide variety of applications in television receivers employing series-connected heater strings. Outline 12, OUTLINES SECTION. Heater volts (ac/dc), 4.7;

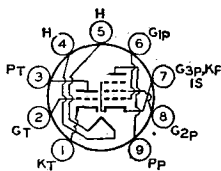

amperes, 0.6; warm-up time (average), 11 seconds. For definition of heater warm-up time and method for determining it, see type 6CG7. Except for heater rating and basing arrangement, type 5AV8 is identical with miniature type 6AN8.

**FULL-WAVE VACUUM RECTIFIER**

**5AZ4**

Lock-in type used in power supply of radio equipment having moderate dc requirements. Outline 20, OUTLINES SECTION. Tube requires lock-in socket. Filament volts, 5; amperes, 2. For maximum ratings, typical operation, and curves, refer to glass-octal type 5Y3-GT. Type 5AZ4 is used principally for renewal purposes.

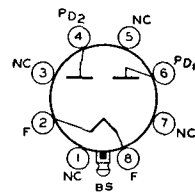

**MEDIUM-MU TWIN TRIODE**

**5BQ7-A**

Miniature type used as rf and as if amplifier in television receivers employing series-connected heater strings. Outline 12, OUTLINES SECTION. Heater volts (ac/dc), 4.7; amperes, 0.45;

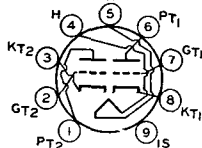

warm-up time (average), 11 seconds. For definition of heater warm-up time and method for determining it, see type 6CG7. Except for heater rating, type 5BQ7-A is identical with miniature type 6BQ7-A.

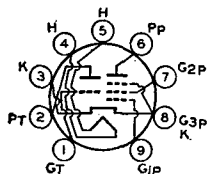

**TRIODE-PENTODE CONVERTER**

**5CG8**

Miniature type used as combined oscillator and mixer tube in television receivers employing series-connected heater strings. When used in an AM/FM receiver, the triode unit is used as

an oscillator in both sections. In the AM section, the pentode unit is used as a high-gain pentode mixer; in the FM section, the pentode unit is used either as a pentode mixer or as a triode-connected mixer depending on signal-to-noise considerations. Outline 12, OUTLINES SECTION. Heater volts (ac/dc), 4.7; amperes, 0.6; warm-up time (average), 11 seconds. For definition of heater warm-up time and method for determining it, see type 6CG7. Except for heater rating, type 5CG8 is identical with miniature type 6CG8.

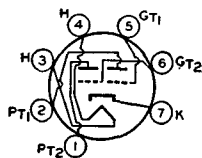

**MEDIUM-MU TWIN TRIODE**

**5J6**

Miniature type used as oscillator, rf amplifier, or mixer tube in television receivers employing series-connected heater strings. Outline 11, OUTLINES SECTION. Heater volts (ac/dc), 4.7;

amperes, 0.6; warm-up time (average), 11 seconds. For definition of heater warm-up time and method for determining it, see type 6CG7. Peak heater-cathode volts, 200 max. When the heater is positive with respect to the cathode, the dc component of the heater-cathode voltage must not exceed 100 volts. Except for heater and heater-cathode ratings, type 5J6 is identical with miniature type 6J6.

**FULL-WAVE VACUUM RECTIFIER**

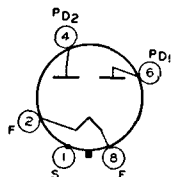

**5T4**

Metal type used in power supply of radio equipment having large dc requirements. Outline 7, OUTLINES SECTION. Tube requires octal socket. Vertical tube mounting is preferred but horizontal mounting is permissible if pins 2 and 8 are in vertical plane. Filament volts (ac), 5.0; amperes, 2.0. Maximum ratings as full-wave rectifier: peak inverse plate volts, 1550 max; peak plate ma., 675 max; dc output ma., 225 max. This type is used principally for renewal purposes.

**Typical Operation:**

	Capacitor	Choke	
AC Plate-to-Plate Supply Voltage (rms) .....	900	1100	volts
Filter-Input Capacitor .....	4	-	μf
Total Effective Plate-Supply Impedance Per Plate† .....	150	-	ohms
Filter-Input Choke .....	-	10	henries
DC Output Current .....	225	225	ma
DC Output Voltage at Input to Filter (Approx.):			
At half-load current (112.5 ma.) .....	530	465	volts
At full-load current (225 ma.) .....	480	450	volts
Voltage Regulation (Approx.):			
Half-load to full-load current .....	50	15	volts

† When a filter-input capacitor larger than 40 μf is used, it may be necessary to use more plate-supply impedance than the value shown in order to limit the peak plate current to the rated value.

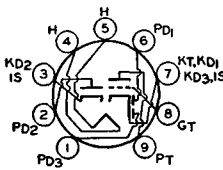

**TRIPLE DIODE-HIGH-MU TRIODE**

**5T8**

Miniature type used as combined AM detector, FM detector, and af voltage amplifier in radio and television receivers employing series-connected heater strings. Diode unit No.1

is used for AM detection, and diode units No.2 and No.3 are used for FM detection.

Outline 12, **OUTLINES SECTION**. Heater volts (ac/dc), 4.7; amperes, 0.6; warm-up time (average), 11 seconds. For definition of heater warm-up time and method for determining it, see type 6CG7. Peak heater-cathode volts, 200 *max*. When the heater is positive with respect to the cathode, the dc component of the heater-cathode voltage must not exceed 100 volts. Except for heater and heater-cathode ratings, type 5T8 is identical with miniature type 6T8.

# 5U4-G

# 5U4-GB

## FULL-WAVE VACUUM RECTIFIER

Glass octal types used in power supplies of radio and television receivers having high dc requirements. 5U4-G Outline 51, 5U4-GB Outline 47, **OUTLINES SECTION**. Tubes require octal

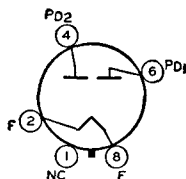

socket. Vertical mounting is preferred but horizontal mounting is permissible if pins 1 and 4 are in vertical plane. The coated filament is designed to operate from the ac line through a step-down transformer. The voltage at the filament terminals should be 5.0 volts at an average line voltage of 117 volts. It is especially important that these tubes, like other power-handling tubes, be adequately ventilated. For discussion of Rating Chart and Operation Characteristics, refer to type 6AX5-GT. Maximum ratings for type 5U4-G as full-wave rectifier: peak inverse plate volts, 1550 *max*; peak plate ma. per plate, 675 *max*. Type 5U4-G is used principally for renewal purposes.

FILAMENT VOLTAGE (AC) .....	5.0	volts
FILAMENT CURRENT .....	3.0	amperes

Maximum Ratings:	FULL-WAVE RECTIFIER		5U4-GB
PEAK INVERSE PLATE VOLTAGE .....			1550 <i>max</i> volts
PEAK PLATE CURRENT PER PLATE .....			1.0 <i>max</i> ampere
HOT-SWITCHING TRANSIENT PLATE CURRENT PER PLATE .....			#
AC PLATE SUPPLY VOLTAGE (RMS) PER PLATE .....			See Rating Chart
DC OUTPUT CURRENT (RMS) PER PLATE .....			See Rating Chart

### Typical Operation of 5U4-GB with Capacitor Input to Filter:

AC Plate-to-Plate Supply Voltage (rms) .....	600	900	1100	volts
Filter-Input Capacitor* .....	40	40	40	μf
Effective Plate-Supply Impedance per Plate .....	21	67	97	ohms
DC Output Voltage at Input to Filter (Approx.):				
At half-load current of	{			
150 ma. ....		335	-	volts
137.5 ma. ....		-	520	volts
81 ma. ....		-	-	680
At full-load current of	{			
300 ma. ....		290	-	volts
275 ma. ....		-	460	volts
162 ma. ....		-	-	630
Voltage Regulation (Approx.):				
Half-load to full-load current .....	45	60	50	volts

### Typical Operation of 5U4-GB with Choke Input to Filter:

AC Plate-to-Plate Supply Voltage (rms) .....	900	1100	volts	
Filter-Input Choke .....	10	10	henries	
DC Output Voltage at Input to Filter (Approx.):				
At half-load current of	{			
174 ma. ....		355	-	volts
137.5 ma. ....		-	455	volts
At full-load current of	{			
348 ma. ....		340	-	volts
275 ma. ....		-	440	volts
Voltage Regulation (Approx.):				
Half-load to full-load current .....	15	15	volts	

\*If hot switching is regularly required in operation, the use of choke-input circuits is recommended. Such circuits limit the hot-switching current to a value no higher than that of the peak plate current. When capacitor-input circuits are used, a maximum peak current value per plate of 4.6 amperes during the initial cycles of the hot-switching transient should not be exceeded.

\*Higher values of capacitance than indicated may be used, but the effective plate-supply impedance may have to be increased to prevent exceeding the maximum rating for peak plate current.

## RATING CHART

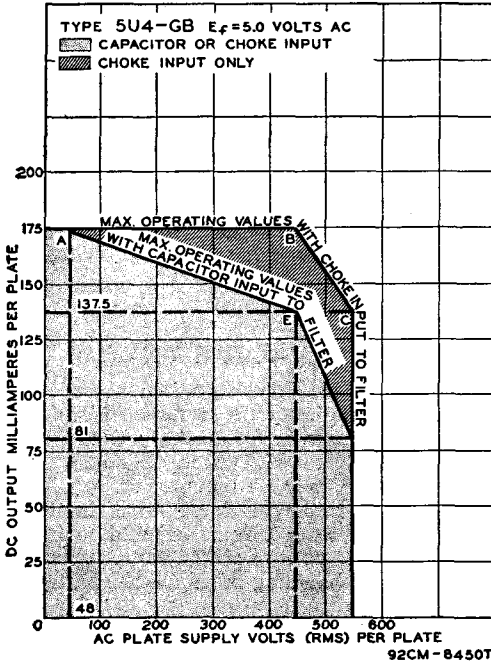

### OPERATION CHARACTERISTICS FULL-WAVE CIRCUIT, CAPACITOR INPUT TO FILTER

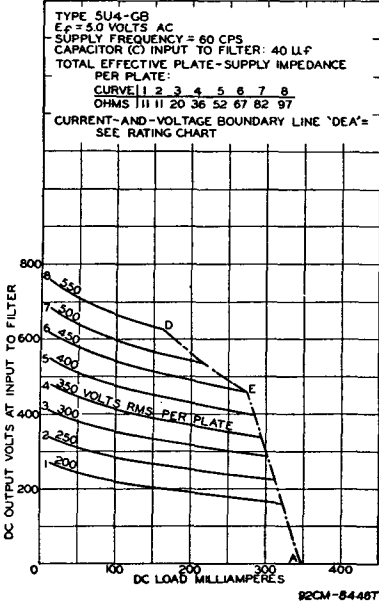

### OPERATION CHARACTERISTICS FULL-WAVE CIRCUIT, CHOKE INPUT TO FILTER

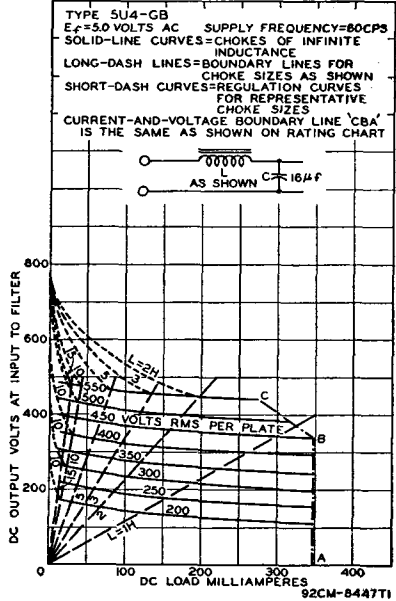

**TRIODE—PENTODE CONVERTER**

**5U8**

Miniature type used as combined oscillator and mixer tube in AM/FM receivers and television receivers employing series-connected heater strings. Outline 12, OUTLINES SECTION.

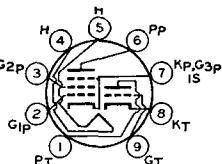

Heater volts (ac/dc), 4.7; amperes, 0.6; warm-up time (average), 11 seconds. For definition of heater warm-up time and method for determining it, see type 6CG7. Peak heater-cathode volts, 200 *max*. When the heater is positive with respect to the cathode, the dc component of the heater-cathode voltage must not exceed 100 volts. Except for heater and heater-cathode rating, type 5U8 is identical with miniature type 6U8.

**FULL-WAVE VACUUM RECTIFIER**

**5V4-G**

Glass octal type used in power supply of radio equipment having high dc requirements. Outline 41, OUTLINES SECTION. Tube requires octal socket and may be mounted in any

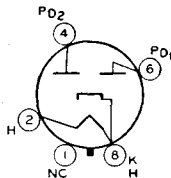

position. The heater is designed to operate from the ac line through a step-down transformer. The voltage at the heater terminals should be 5.0 volts under operating conditions at an average line voltage of 117 volts. It is especially important that this tube, like other power-handling tubes, be adequately ventilated.

HEATER VOLTAGE (AC) .....	5.0	volts
HEATER CURRENT .....	2.0	amperes

<b>Maximum Ratings:</b>	<b>FULL-WAVE RECTIFIER</b>	
PEAK INVERSE PLATE VOLTAGE .....	1400 <i>max</i>	volts
PEAK PLATE CURRENT (Per Plate) .....	525 <i>max</i>	ma
DC OUTPUT CURRENT .....	175 <i>max</i>	ma

<b>Typical Operation:</b>			
<i>Filter Input</i>	<i>Capacitor</i>	<i>Choke</i>	
AC Plate-to-Plate Supply Voltage (rms) .....	750	1000	volts
Filter-Input Capacitor .....	8	-	$\mu$ f
Total Effective Plate-Supply Impedance (Per Plate) .....	100	-	ohms
Min. Filter-Input Choke .....	-	4	henries

OPERATION CHARACTERISTICS

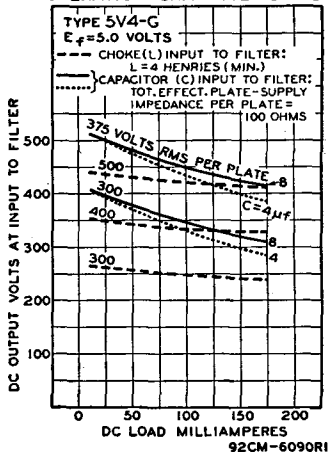

DC Output Current .....	175	175	ma
DC Output Voltage at Input to Filter (Approx.):			
At half-load current (87.5 ma.) .....	455	425	volts
At full-load current (175 ma.) .....	415	415	volts
Voltage Regulation (Approx.):			
Half-load to full-load current .....	40	10	volts

\* When a filter-input capacitor larger than 40  $\mu$ f is used, it may be necessary to use more plate-supply impedance than the value shown to limit the peak plate current to the rated value.

## FULL-WAVE VACUUM RECTIFIER

Metal type 5W4 and glass-octal type 5W4-GT are used in power supply of radio equipment having low dc requirements. Outlines 6 and 26, respectively, OUTLINES SECTION. Both types require octal socket. Filament volts (ac), 5.0; amperes, 1.5. Maximum ratings: peak inverse plate volts, 1400 *max*; peak plate ma., 300 *max*; dc output ma., 100 *max*. These are DISCONTINUED types listed for reference only.

## 5W4 5W4-GT

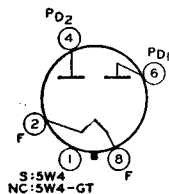

## FULL-WAVE VACUUM RECTIFIER

Glass octal type used in power supply of radio equipment having large dc requirements. Outline 51, OUTLINES SECTION. Filament volts, 5.0; amperes, 3.0. Except for basing arrangement, this type is identical with type 5U4-G. Type 5X4-G is used principally for renewal purposes.

## 5X4-G

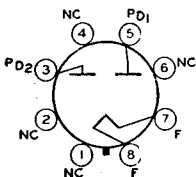

## TRIODE-PENTODE CONVERTER

Miniature type used as combined oscillator and mixer in AM/FM receivers and television receivers employing series-connected heater strings. Outline 12, OUTLINES SECTION.

## 5X8

Heater volts (ac/dc), 4.7; amperes, 0.6; warm-up time (average), 11 seconds. For definition of heater warm-up time and method for determining it, see type 6CG7. Peak heater-cathode volts, 200 *max*. When the heater is positive with respect to the cathode, the dc component of the heater-cathode voltage must not exceed 100 volts. Except for heater and heater-cathode ratings, type 5X8 is identical with miniature type 6X8.

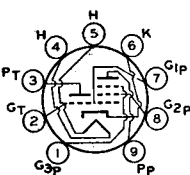

## FULL-WAVE VACUUM RECTIFIER

Glass octal types used in power supply of radio equipment having moderate dc requirements. Type 5Y3-G, Outline 41; type 5Y3-GT, Outline 26, OUTLINES SECTION. Tubes require

## 5Y3-G 5Y3-GT

octal socket. Vertical tube mounting is preferred, but horizontal operation is permissible if pins 2 and 8 are in horizontal plane. It is especially important that these tubes, like other power-handling tubes, be adequately ventilated. Type 5Y3-G is a DISCONTINUED type listed for reference only. For discussion of Rating Chart and Operation Characteristics, refer to type 6AX5-GT.

FILAMENT VOLTAGE (AC) .....	5.0	5.0	volts
FILAMENT CURRENT .....	2.0	2.0	amperes

**Maximum Ratings:**
**FULL-WAVE RECTIFIER**

PEAK INVERSE PLATE VOLTAGE .....	1400 max	volts
PEAK PLATE CURRENT (Per Plate) .....	400 max	ma
<b>HOT-SWITCHING TRANSIENT PLATE CURRENT</b>		
For duration of 0.2 second maximum .....	2.2 max	amperes
AC PLATE SUPPLY VOLTAGE (Per Plate, rms) .....	See Rating Chart	
DC OUTPUT CURRENT (Per Plate, rms) .....	See Rating Chart	

**Typical Operation with Capacitor Input to Filter:**

AC Plate-to-Plate Supply Voltage (rms) .....	700	1000	volts
Filter Input Capacitor* .....	10	10	μf
Effective Plate-Supply Impedance (Per Plate) .....	50	140	ohms
<b>DC Output Voltage at Input to Filter (Approx.):</b>			
At half-load current of { 62.5 ma .....	390	-	volts
{ 42 ma .....	-	610	volts
At full-load current of { 125 ma .....	350	-	volts
{ 84 ma .....	-	560	volts
<b>Voltage Regulation (Approx.):</b>			
Half-load to full-load current .....	40	50	volts

**Typical Operation with Choke Input to Filter:**

AC Plate-to-Plate Supply Voltage (rms) .....	700	1000	volts
Filter Input Choke .....	10 #	10 # #	henries
<b>DC Output Voltage at Input to Filter (Approx.):</b>			
At half-load current of { 75 ma .....	270	-	volts
{ 62.5 ma .....	-	405	volts
At full-load current of { 150 ma .....	245	-	volts
{ 125 ma .....	-	390	volts
<b>Voltage Regulation (Approx.):</b>			
Half-load to full-load current .....	25	15	volts

\* Higher values of capacitance than indicated may be used but the effective plate supply impedance may have to be increased to prevent exceeding the maximum rating for hot-switching transient plate current.

# This value is adequate to maintain optimum regulation in the region to the right of line L=10H on curve OPERATION CHARACTERISTICS with Choke Input to Filter, provided the load current is not less than 35 ma. For load currents less than 35 ma, a larger value of inductance is required for optimum regulation.

# # This value is adequate to maintain optimum regulation in the region to the right of line L=10H on curve OPERATION CHARACTERISTICS with Choke Input to Filter, provided the load current is not less than 50 ma. For load currents less than 50 ma, a larger value of inductance is required for optimum regulation.

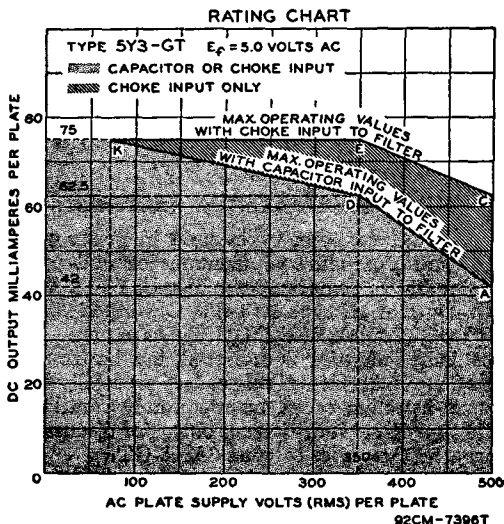



OPERATION CHARACTERISTICS

FULL-WAVE CIRCUIT, CAPACITOR INPUT TO FILTER

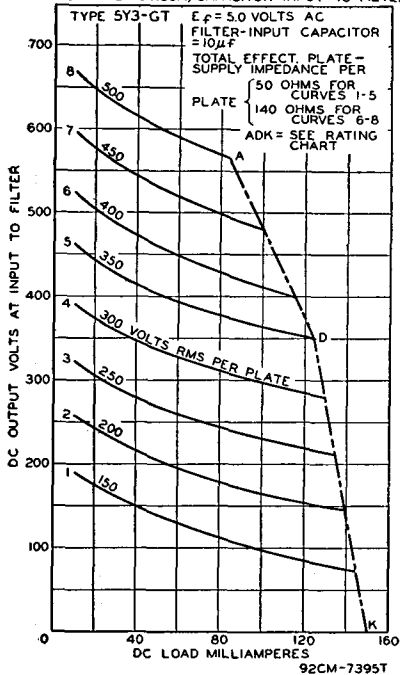

OPERATION CHARACTERISTICS

FULL-WAVE CIRCUIT, CHOKE INPUT TO FILTER

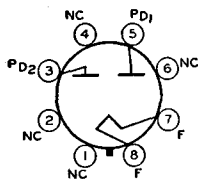
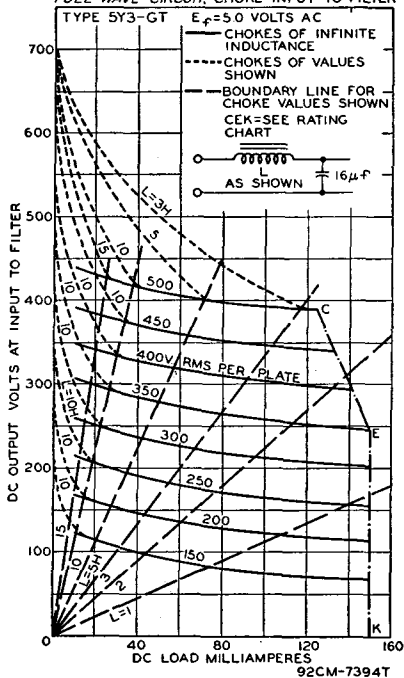

FULL-WAVE VACUUM RECTIFIER

Glass octal types used in power supplies of radio equipment having moderate dc requirements. 5Y4-G Outline 41, 5Y4-GT Outline 26, OUTLINES SECTION. Tubes require octal socket. Type 5Y4-GT is supplied with pins No.4 and No.6 missing. Vertical tube mounting is preferred, but horizontal operation is permissible if pins No.2 and No.7 are in horizontal plane. Filament volts (ac), 5.0; amperes, 2.0. For maximum ratings, typical operation, and curves, refer to type 5Y3-GT. It is especially important that these tubes, like other power-handling tubes, be adequately ventilated. Type 5Y4-G is a DISCONTINUED type listed for reference only

5Y4-G

5Y4-GT

require octal socket. Type 5Y4-GT is supplied with pins No.4 and No.6 missing. Vertical tube mounting is preferred, but horizontal operation is permissible if pins No.2 and No.7 are in horizontal plane. Filament volts (ac), 5.0; amperes, 2.0. For maximum ratings, typical operation, and curves, refer to type 5Y3-GT. It is especially important that these tubes, like other power-handling tubes, be adequately ventilated. Type 5Y4-G is a DISCONTINUED type listed for reference only

FULL-WAVE VACUUM RECTIFIER

Glass type used in power supply of radio equipment having large dc requirements. Outline 52, OUTLINES SECTION. Tube requires four-contact socket. Vertical mounting is preferred but horizontal mounting is permissible if pins 1 and 4 are in horizontal plane. Filament volts (ac), 5.0; amperes, 3.0. For maximum ratings, refer to type 5U4-G. Type 5Z3 is used principally for renewal purposes.

5Z3

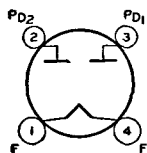

**FULL-WAVE VACUUM RECTIFIER**

**5Z4**

Metal type used in power supply of radio equipment having moderate dc requirements. Outline 6, OUTLINES SECTION. Tube requires octal socket and may be mounted in

any position. Heater volts (ac), 5.0; amperes, 2.0. Maximum ratings: peak inverse plate volts, 1400 *max*; peak plate ma. per plate, 375 *max*. Typical operation as full-wave rectifier with capacitor-input filter: ac plate-to-plate supply volts (rms), 700; total effective plate-supply impedance per plate, 50 ohms; dc output ma., 125. Typical operation with choke-input filter: ac plate-to-plate supply volts, 1000; minimum filter-input choke, 5 henries; dc output ma., 125.

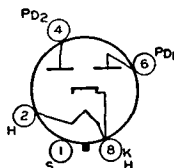

**POWER TRIODE**

**6A3**

Glass type used in output stage of radio receivers. Outline 52, OUTLINES SECTION. Tube requires four-contact socket. Filament volts (ac/dc), 6.3; amperes, 1.0. This type is identical electrically with type 6B4-G. Type 6A3 is a DISCONTINUED type listed for reference only.

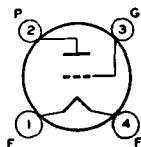

**POWER PENTODE**

**6A4/LA**

Glass type used in output stage of automobile receivers. Outline 42, OUTLINES SECTION. Tube requires five-contact socket. Filament volts (ac/dc), 6.3; amperes, 0.3. Typical operation: plate and grid-No. 2 volts, 180 *max*; grid-No. 1 volts, -12; plate ma., 22; grid-No. 2 ma., 3.9; plate resistance, 45500 ohms approx.; transconductance, 2200  $\mu$ mhos; load resistance, 8000 ohms; cathode-bias resistor, 465 ohms; output watts, 1.4. This is a DISCONTINUED type listed for reference only.

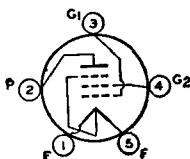

**HIGH-MU TWIN POWER TRIODE**

**6A6**

Glass type used in output stage of ac-operated receivers as a class B power amplifier or with units in parallel as a class A<sub>1</sub> amplifier to drive a 6A6 as class B amplifier. Outline 42, OUTLINES SECTION. Tube requires medium seven-contact (0.855-inch, pin-circle diameter) socket. Filament volts (ac/dc), 6.3; amperes, 0.8. This type is electrically identical with type 6N7. Type 6A6 is a DISCONTINUED type listed for reference only.

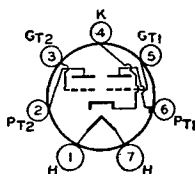

**PENTAGRID CONVERTER**

**6A7**

**6A7S**

Glass types used in superheterodyne circuits. Outline 39, OUTLINES SECTION. These types require the small seven-contact (0.75-inch, pin-circle diameter) socket. Except for interelectrode capacitances, the 6A7 is identical electrically with type 6A8. Type 6A7S, now DISCONTINUED, has the external shield connected to cathode. In general, its electrical characteristics are similar to those of the 6A7, but

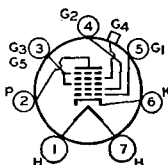

the two types are usually not directly interchangeable. Type 6A7 is used principally for renewal purposes.

### PENTAGRID CONVERTER

**6A8**  
**6A8-G**  
**6A8-GT**

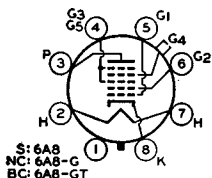

Metal type 6A8 and glass octal types 6A8-G and 6A8-GT used in superheterodyne circuits. 6A8 Outline 4, 6A8-G Outline 38, 6A8-GT Outline 24, OUTLINES SECTION. Tubes require octal socket. Heater volts (ac/dc), 6.3; amperes, 0.3. For heater and cathode considerations, refer to type 6AV6. Maximum ratings: plate, grids-No.3-and-No.5-supply, and grid-No.2-supply volts, 300 *max*; grids-No.3-and-

No.5 (screen-grid) volts, 100 *max*; grid-No.2 (anode-grid) volts, 200 *max*; grid-No.4 (control-grid) volts, 0 *max*; plate dissipation, 1 *max* watt; grids-No.3-and-No.5 input, 0.3 *max* watt; grid-No.2 input, 0.75 *max* watt; total cathode ma., 14 *max*; peak heater-cathode volts, 90 *max*. These types are used principally for renewal purposes.

**Characteristics:**

**CONVERTER SERVICE**

Plate Voltage	100	250	volts
Grids-No. 3-and-No. 5 Voltage	50	100	volts
Grid-No. 2 Voltage	100	-	volts
Grid-No. 2 Supply Voltage	-	250*	volts
Grid-No. 4 Voltage	-1.5	-3	volts
Grid-No. 1 (Oscillator-Grid) Resistor	50000	50000	ohms
Plate Resistance (Approx.)	0.6	0.36	megohm
Conversion Transconductance	360	550	$\mu$ mhos
Conversion Transconductance (Approx.) with grid-No.4 voltage of -20 volts	3	-	$\mu$ mhos
Conversion Transconductance (Approx.) with grid-No.4 voltage of -35 volts	-	6	$\mu$ mhos
Plate Current	1.1	3.5	ma
Grids-No. 3-and-No. 5 Current	1.3	2.7	ma
Grid-No. 2 Current	2	4	ma
Grid-No. 1 Current	0.25	0.4	ma
Total Cathode Current	4.6	10.6	ma

\* Grid-No.2 supply voltages in excess of 200 volts require use of 20000-ohm voltage-dropping resistor bypassed by 0.1- $\mu$ f capacitor.

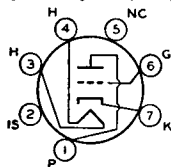

### HIGH-MU TRIODE

Miniature type used as cathode-drive amplifier, frequency converter, or oscillator at frequencies up to about 300 megacycles per second particularly in television and FM receivers. Outline 11, OUTLINES SECTION. Tube requires miniature seven-contact socket and may be mounted in any position. Heater volts (ac/dc), 6.3; amperes, 0.15. For maximum ratings, characteristics, and curves, refer to type 12AT7. For heater and cathode considerations, refer to type 6AV6.

**6AB4**

### ELECTRON-RAY TUBE

Glass type used to indicate visually by means of a fluorescent target the effects of a change in a controlling voltage. It is used as a convenient means of indicating accurate radio-receiver tuning. Outline 34, OUTLINES SECTION. Tube requires six-contact socket. For heater and cathode considerations, refer to type 6AV6. Heater volts (ac/dc) 6.3; amperes, 0.15. Ratings: plate-supply volts, 180 *max*; target volts, 180 *max*, 125 *min*. This type is used principally for renewal purposes.

**6AB5/**  
**6N5**

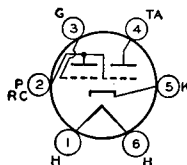

### REMOTE-CUTOFF PENTODE

Metal type used in rf and if stages of picture amplifier of television receivers particularly those employing automatic-gain control. Outline 3, OUTLINES SECTION. Tube requires octal socket. Heater volts (ac/dc), 6.3; amperes, 0.45. Maximum ratings as class A1 amplifier: plate and grid-No. 2 supply volts, 300 *max*; grid-No.2 volts, 200 *max*; plate dissipation, 3.75 *max* watts; grid-No.2 input, 0.7 *max* watt. Typ-

**6AB7**

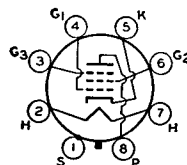

ical operation: plate and grid-No.2 supply volts, 300; grid-No.3 volts, 0; grid-No.2 series

resistor, 30000 ohms; grid-No.1 volts, -3; plate resistance (approx.), 0.7 megohm; transconductance, 5000  $\mu$ mhos; grid-No.1 volts for transconductance of 50  $\mu$ mhos, -15; plate ma., 12.5; grid-No.2 ma., 3.2. This type is used principally for renewal purposes.

### HIGH-MU POWER TRIODE

Glass octal type used in single-ended or push-pull audio-frequency power amplifiers of the direct-coupled type in which a driver tube develops positive grid bias for the 6AC5-GT output stage. Outline 23, OUTLINES SECTION. This type may be supplied with pin No. 1 omitted. Tube requires octal socket. Heater

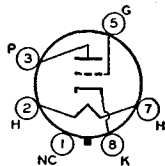

## 6AC5-GT

volts (ac/dc), 6.3; amperes, 0.4. Maximum ratings: plate volts, 250 *max*; peak plate ma. (per tube), 110 *max*; average plate dissipation, 10 *max* watts. This type is used principally for renewal purposes.

### SHARP-CUTOFF PENTODE

Metal type used in rf and if stages of picture amplifier and the first stages of the video amplifier of television receivers. It is also used as a mixer or oscillator tube in low-frequency applications. Outline 3, OUTLINES SECTION. Tube requires octal socket. When tube

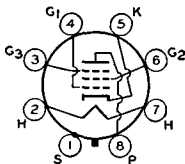

## 6AC7

is used as a high-gain audio amplifier, heater should be operated from a battery source. For other heater considerations, refer to type 6AQ5.

HEATER VOLTAGE (AC/DC).....	6.3	volts
HEATER CURRENT.....	0.45	ampere

Maximum Ratings:	CLASS A <sub>1</sub> AMPLIFIER		
PLATE VOLTAGE.....	300 <i>max</i>	volts	
GRID-NO.2 (SCREEN-GRID) VOLTAGE.....	See curve page 67		
GRID-NO.2 SUPPLY VOLTAGE.....	300 <i>max</i>	volts	
PLATE DISSIPATION.....	3 <i>max</i>	watts	
GRID-NO.2 INPUT:			
For grid-No.2 voltages up to 150 volts.....	0.4 <i>max</i>	watt	
For grid-No.2 voltages between 150 and 300 volts.....	See curve page 67		
PEAK HEATER-CATHODE VOLTAGE:			
Heater negative with respect to cathode.....	90 <i>max</i>	volts	
Heater positive with respect to cathode.....	90 <i>max</i>	volts	

Characteristics:			
Plate Supply Voltage.....	300	300	volts
Grid-No. 3 Voltage.....	0	0	volts
Grid-No. 2 Supply Voltage.....	150	300 #	volts
Grid-No. 2 Series Resistor.....	-	6000	ohms
Min. Cathode-Bias Resistor.....	160	160	ohms
Plate Resistance (Approx.).....	1	1	megohm
Transconductance.....	9000	9000	$\mu$ mhos
Plate Current.....	10	10	ma
Grid-No. 2 Current.....	2.5	2.5	ma

Maximum Circuit Values:		
Grid-No.1-Circuit Resistance:		
For cathode-bias operation with fixed grid-No.2 voltage.....	0.25 <i>max</i>	megohm
For cathode-bias operation with grid-No.2 resistor.....	0.50 <i>max</i>	megohm

# Grid-No.2 supply voltages in excess of 150 volts require use of a series dropping resistor to limit the voltage at grid No. 2 to 150 volts when the plate current is at its normal value of 10 milliamperes.

### ELECTRON-RAY TUBE

Glass octal type used to indicate visually, by means of two shadows on the fluorescent target, the effects of changes in the controlling voltages. It is a twin-indicator type and is used as a convenient means of indicating accurate radio-receiver tuning. Maximum over-all length, 2-7/8 inches; maximum diameter, 1-5/16 inches. Heater volts (ac/dc), 6.3; amperes, 0.15. Maximum target volts, 150. This is a DISCONTINUED type listed for reference only

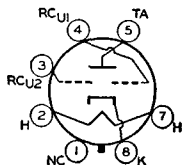

## 6AD6-G

**TRIODE—POWER PENTODE**

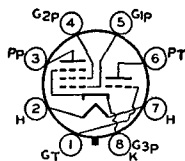

Glass octal type used in a push-pull amplifier circuit in conjunction with type 6F6-G. Triode unit serves as phase inverter. Outline 41, OUTLINES SECTION. Tube requires octal socket. Heater volts (ac/dc), 6.3; amperes, 0.85. For typical operation of pentode unit, refer to type 6F6-G. Maximum ratings of pentode unit as class A<sub>1</sub> or push-pull class AB<sub>1</sub> amplifier: plate volts, 375 *max*; grid-No. 2 volts, 285 *max*; plate dissipation, 8.5 *max* watts; grid-No.2 input, 2.7 *max* watts. Maximum ratings of triode unit as class A<sub>1</sub> amplifier: plate volts, 285 *max*; plate dissipation, 1.0 *max* watt. This type is used principally for renewal purposes.

**6AD7-G**

**LOW-MU TRIODE**

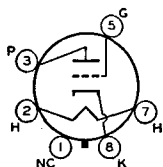

Glass octal type used as class A<sub>1</sub> amplifier in ac/dc radio receivers. Outline 23, OUTLINES SECTION. Heater volts (ac/dc), 6.3; amperes, 0.3. Maximum ratings as class A<sub>1</sub> amplifier: plate volts, 300 *max*; plate dissipation, 2.5 *max* watts. This is a DISCONTINUED type listed for reference only.

**6AE5-GT**

**TWIN-PLATE CONTROL TUBE**

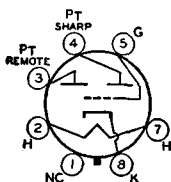

Glass octal type used as a control tube for twin-indicator type electron-ray tubes. Outline 36, OUTLINES SECTION. Contains two triodes with different cutoff characteristics. If avc voltage is applied to the common control grid in suitable circuit, one triode section operates on weak signals while the other operates on strong signals. Heater voltage (ac/dc), 6.3; amperes, 0.15. This is a DISCONTINUED type listed for reference only.

**6AE6-G**

**TWIN-INPUT TRIODE**

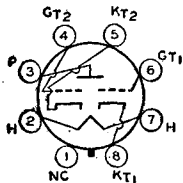

Glass octal type used as a voltage amplifier or as a driver for two type 6AC5-GT tubes in dynamic-coupled, push-pull amplifiers. In the latter service, type 6AE7-GT replaces two tubes ordinarily required as drivers. Outline 23, OUTLINES SECTION. Heater volts (ac/dc), 6.3; amperes, 0.5. This is a DISCONTINUED type listed for reference only.

**6AE7-GT**

**MEDIUM-MU TRIODE**

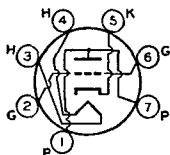

Miniature types used as local oscillators in uhf television receivers covering the frequency range of 470 to 890 megacycles per second. 6AF4 Outline 11, 6AF4-A Outline 9, OUTLINES SECTION. Tubes require miniature seven-contact socket and may be mounted in any position. Type 6AF4 is a DISCONTINUED type listed for reference only.

**6AF4**

**6AF4-A**

HEATER VOLTAGE (AC/DC) .....	6.3	volts
HEATER CURRENT .....	0.225	ampere
DIRECT INTERELECTRODE CAPACITANCES:		
Grid to Plate .....	1.9	μf
Grid to Cathode and Heater .....	2.2	μf
Plate to Cathode and Heater .....	0.45	μf

<b>Characteristics:</b>	<b>CLASS A<sub>1</sub> AMPLIFIER</b>	
Plate Supply Voltage .....	80	100
Cathode-Bias Resistor .....	150	150
Amplification Factor .....	15	16
Plate Resistance .....	2270	2130
Transconductance .....	6600	7500
Plate Current .....	16	20

## OSCILLATOR IN UHF TELEVISION RECEIVERS

### Maximum Ratings:

DC PLATE VOLTAGE .....	150 <i>max</i>	volts
DC GRID VOLTAGE .....	-50 <i>max</i>	volts
DC GRID CURRENT .....	8 <i>max</i>	ma
PLATE INPUT .....	2.5 <i>max</i>	watts
PLATE DISSIPATION .....	2.25 <i>max</i>	watts
DC CATHODE CURRENT .....	28 <i>max</i>	ma
<b>PEAK HEATER-CATHODE VOLTAGE:*</b>		
Heater negative with respect to cathode .....	50 <i>max</i>	volts
Heater positive with respect to cathode .....	50° <i>max</i>	volts

### Typical Operation as Oscillator at 950 Mc:

DC Plate Voltage .....	100	volts
DC Grid Voltage .....	-4	volts
From a grid resistor of .....	10000	ohms
DC Plate Current .....	22	ma
DC Grid Current (Approx.) .....	400	μa
Useful Power Output .....	160	mw

### Maximum Circuit Values:

<b>Grid-Circuit Resistance:</b>		
For fixed-bias operation .....		Not recommended
For cathode-bias operation .....		0.5 <i>max</i> megohm

\* It is recommended that the heater be kept at cathode potential to minimize the effects of variation in the heater-to-cathode capacitance between tubes.

°The dc component must not exceed 25 volts.

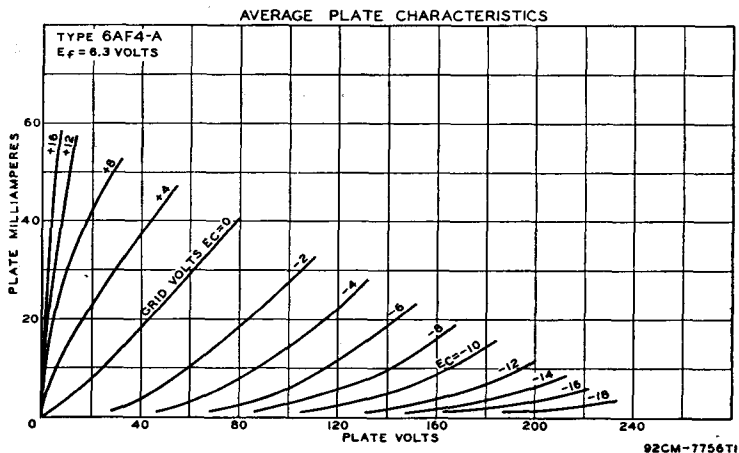

## 6AF6-G

### ELECTRON-RAY TUBE

Glass octal type used to indicate visually, by means of two shadows on the fluorescent target, the effects of changes in the controlling voltages. It is a twin-indicator type and is used as

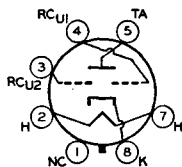

a convenient means of indicating accurate radio-receiver tuning. Maximum over-all length, 2-5/16 inches; maximum diameter, 1-9/32 inches. This type may be supplied with pin No.1 omitted. Tube requires octal socket. Heater volts (ac/dc), 6.3; amperes, 0.15. Ratings: target volts, 250 *max*, 125 *min*; ray-control-electrode supply volts, 250 *max*; peak heater-cathode volts, 90 *max*. Typical operation: target volts, 250; target ma., 2.2; series resistor, 1 megohm; ray-control-electrode volts (approx. for 0° shadow angle), 160; ray-control-electrode volts (approx. for 90° shadow angle), 0

### SHARP-CUTOFF PENTODE

# 6AG5

Miniature type used in compact radio equipment as an rf or if amplifier up to 400 megacycles per second. Outline 11, OUTLINES SECTION.

Tube requires miniature seven-con-

tact socket and may be mounted in any position. The two cathode leads facilitate isolation of the input and output circuits thus helping to minimize degeneration. For heater and cathode considerations, refer to type 6AV6.

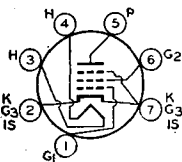

HEATER VOLTAGE (AC/DC).....	6.3	volts
HEATER CURRENT.....	0.3	ampere
DIRECT INTERELECTRODE CAPACITANCES:		
Grid No. 1 to Plate.....	0.030 max	$\mu\mu\text{f}$
Grid No.1 to Cathode, Heater, Grid No.2, Grid No.3, and Internal Shield	6.5	$\mu\mu\text{f}$
Plate to Cathode, Heater, Grid No.2, Grid No.3, and Internal Shield....	1.8	$\mu\mu\text{f}$

**Maximum Ratings:**

**CLASS A<sub>1</sub> AMPLIFIER**

PLATE VOLTAGE.....	300 max	volts
GRID-NO. 2 (SCREEN-GRID) VOLTAGE.....	See curve page 67	
GRID-NO.2 SUPPLY VOLTAGE.....	300 max	volts
PLATE DISSIPATION.....	2 max	watts
GRID-NO.2 INPUT:		
For grid-No.2 voltages up to 150 volts.....	0.5 max	watt
For grid-No.2 voltages between 150 and 300 volts.....	See curve page 67	
PEAK HEATER-CATHODE VOLTAGE:		
Heater negative with respect to cathode.....	90 max	volts
Heater positive with respect to cathode.....	90 max	volts

**Characteristics:**

Plate Supply Voltage.....	100	125	250	volts
Grid-No.2 Supply Voltage.....	100	125	150	volts
Cathode-Bias Resistor.....	180	100	180	ohms
Plate Resistance (Approx.).....	0.6	0.5	0.8	megohm
Transconductance.....	4500	5100	5000	$\mu\text{mhos}$
Grid-No.1 Voltage for plate current of 10 $\mu\text{a}$ .....	-5	-6	-8	volts
Plate Current.....	4.5	7.2	6.5	ma
Grid-No. 2 Current.....	1.4	2.1	2	ma

**Maximum Ratings (Triode Connection):\***

PLATE VOLTAGE.....	300 max	volts
PLATE DISSIPATION.....	2.5 max	watts

**Typical Operation (Triode Connection):\***

Plate Voltage.....	180	250	volts
Cathode-Bias Resistor.....	330	820	ohms

AVERAGE PLATE CHARACTERISTICS  
PENTODE CONNECTION

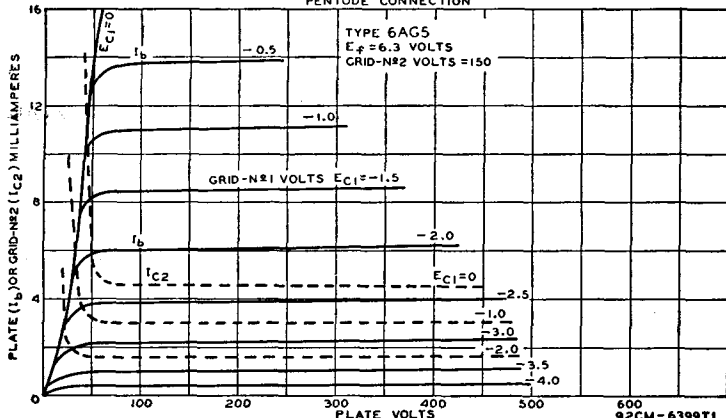

92CM-6399T1

Plate Resistance.....	8000	10000	ohms
Amplification Factor.....	45	42	
Transconductance.....	5700	3800	$\mu$ mhos
Plate Current.....	7.0	5.5	ma

\*Grid No. 2 tied to plate.

## 6AG7

### POWER PENTODE

Metal type used in output stage of video amplifier of television receivers. Outline 6, OUTLINES SECTION. Tube requires octal socket. Heater volts (ac/dc), 6.3; amperes, 0.65. Maximum ratings as class A<sub>1</sub> video voltage amplifier: plate volts, 300 *max*; grid-No.2 volts, 300 *max*; plate dissipation, 9.0 *max* watts; grid-No.2 input, 1.5 *max* watts. Typical operation as a class A<sub>1</sub> amplifier: plate volts, 300; grid-No.2 volts, 150; grid-No.1 volts, -3; peak af grid-No.1 volts, 3; zero-signal plate ma., 30; maximum-signal plate ma., 30.5; zero-signal grid-No.2 ma., 7; maximum-signal grid-No.2 ma., 9; plate resistance, 130000 ohms; transconductance, 11000  $\mu$ mhos; load resistance, 10000 ohms; total harmonic distortion, 7 per cent; maximum-signal output watts, 3.

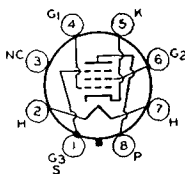

Maximum ratings as class A<sub>1</sub> video voltage amplifier: plate volts, 300 *max*; grid-No.2 volts, 300 *max*; plate dissipation, 9.0 *max* watts; grid-No.2 input, 1.5 *max* watts. Typical operation as a class A<sub>1</sub> amplifier: plate volts, 300; grid-No.2 volts, 150; grid-No.1 volts, -3; peak af grid-No.1 volts, 3; zero-signal plate ma., 30; maximum-signal plate ma., 30.5; zero-signal grid-No.2 ma., 7; maximum-signal grid-No.2 ma., 9; plate resistance, 130000 ohms; transconductance, 11000  $\mu$ mhos; load resistance, 10000 ohms; total harmonic distortion, 7 per cent; maximum-signal output watts, 3.

### MEDIUM-MU TRIODE

Glass octal type having high perveance used as vertical deflection amplifier in television receivers. Outline 22, OUTLINES SECTION. Tube requires octal socket and may be mounted in any position. Heater volts (ac/dc), 6.3; amperes, 0.75. Characteristics as class A<sub>1</sub> amplifier: plate volts, 250; grid volts, -23, amplification factor, 8; plate resistance (approx.), 1780 ohms; transconductance, 4500  $\mu$ mhos; plate ma., 30. This type is used principally for renewal purposes.

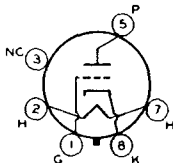

## 6AH4-GT

### VERTICAL DEFLECTION AMPLIFIER

*For operation in a 525-line, 30-frame system*

#### Maximum Ratings:

DC PLATE VOLTAGE.....	500 <i>max</i>	volts
PEAK POSITIVE-PULSE PLATE VOLTAGE# (Absolute maximum).....	2000 <sup>o</sup> <i>max</i>	volts
PEAK NEGATIVE-PULSE GRID VOLTAGE.....	-200 <i>max</i>	volts
CATHODE CURRENT:		
Peak.....	180 <i>max</i>	ma
Average.....	60 <i>max</i>	ma
PLATE DISSIPATION.....	7.5 <i>max</i>	watts
PEAK HEATER-CATHODE VOLTAGE:		
Heater negative with respect to cathode.....	200 <i>max</i>	volts
Heater positive with respect to cathode.....	200 <i>max</i>	volts

#### Maximum Circuit Value (For maximum rated conditions):

Grid-Circuit Resistance:	
For cathode-bias operation.....	2.2 <i>max</i> megohms

# The duration of the voltage pulse must not exceed 15 per cent of one vertical scanning cycle. In a 525-line, 30-frame system, 15 per cent of one vertical scanning cycle is 2.5 milliseconds.

<sup>o</sup> Under no circumstances should this absolute value be exceeded.

■ The dc component must not exceed 100 volts.

### SHARP-CUTOFF PENTODE

Miniature type used as if amplifier in video stages of television receivers. Outline 11, OUTLINES SECTION. Tube requires miniature seven-contact socket and may be mounted in any position. Heater volts (ac/dc), 6.3; amperes, 0.45. For heater and cathode considerations, refer to type 6AQ5. This type is used principally for renewal purposes.

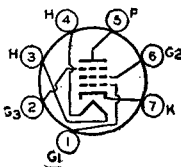

## 6AH6



## CLASS A<sub>1</sub> AMPLIFIER

### Maximum Ratings:

PLATE VOLTAGE.....	300 <i>max</i>	volts
GRID-NO.2 (SCREEN-GRID) VOLTAGE.....	See curve page 67	
GRID-NO.2 SUPPLY VOLTAGE.....	300 <i>max</i>	volts
PLATE DISSIPATION.....	3.2 <i>max</i>	watts
GRID-NO.2 INPUT:		
For grid-No.2 voltages up to 150 volts.....	0.4 <i>max</i>	watt
For grid-No.2 voltages between 150 and 300 volts.....	See curve page 67	
TOTAL CATHODE CURRENT.....	13 <i>max</i>	ma
PEAK HEATER-CATHODE VOLTAGE:		
Heater negative with respect to cathode.....	90 <i>max</i>	volts
Heater positive with respect to cathode.....	90 <i>max</i>	volts

### Characteristics:

	Triode* Connection	Pentode Connection	
Plate Supply Voltage.....	150	300	volts
Grid-No.3 (Suppressor Grid).....	-	Connected to cathode at socket	
Grid-No.2 Supply Voltage.....	150	150	volts
Cathode-Bias Resistor.....	160	160	ohms
Amplification Factor.....	40	-	
Plate Resistance (Approx.).....	3600	500000	ohms
Transconductance.....	11000	9000	mhos
Grid-No.1 Voltage (Approx.) for plate current of 10 $\mu$ a.....	-7	-7	volts
Plate Current.....	12.5	10	ma
Grid-No.2 Current.....	-	2.5	ma

\* Grid No.2 and Grid No.3 tied to plate.

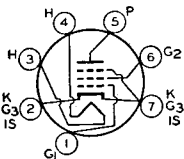

## SHARP-CUTOFF PENTODE

Miniature type used as an rf or if amplifier especially in high-frequency wide-band applications. It is useful as an amplifier at frequencies up to 400 megacycles per second. Outline 9,

# 6AK5

**OUTLINES SECTION.** Tube requires miniature seven-contact socket and may be mounted in any position. For heater and cathode considerations, refer to type 6AV6.

HEATER VOLTAGE (AC/DC).....	6.3	volts
HEATER CURRENT.....	0.175	ampere
DIRECT INTERELECTRODE CAPACITANCES (Approx. with external shield):		
Grid No.1 to Plate.....	0.02 <i>max</i>	$\mu$ f
Grid No.1 to Cathode, Heater, Grid No.2, Grid No.3, and Internal Shield... ..	4.0	$\mu$ f
Plate to Cathode, Heater, Grid No.2, Grid No.3, and Internal Shield.....	2.8	$\mu$ f

### Maximum Ratings:

## CLASS A<sub>1</sub> AMPLIFIER

PLATE VOLTAGE.....	180 <i>max</i>	volts
GRID-NO.2 (SCREEN-GRID) VOLTAGE.....	See curve page 67	
GRID-NO.2 SUPPLY VOLTAGE.....	180 <i>max</i>	volts
PLATE DISSIPATION.....	1.7 <i>max</i>	watts

AVERAGE PLATE CHARACTERISTICS  
PENTODE CONNECTION

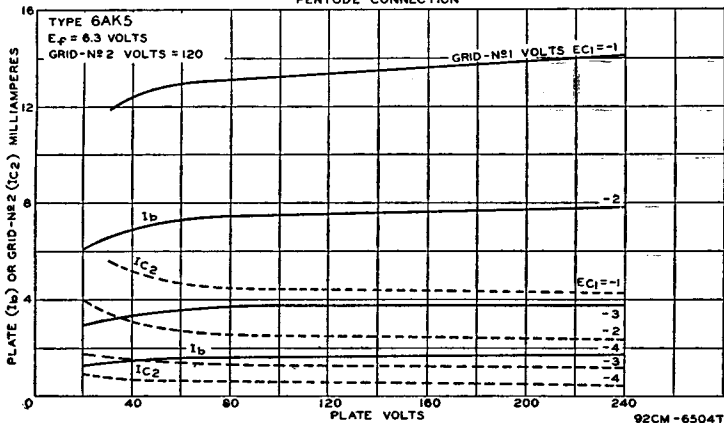

<b>GRID-NO.2 INPUT:</b>		
For grid-No.2 voltages up to 90 volts	0.5 max	watt
For grid-No.2 voltages between 90 and 180 volts	See curve page 67	
<b>CATHODE CURRENT</b>	18 max	ma
<b>PEAK HEATER-CATHODE VOLTAGE:</b>		
Heater negative with respect to cathode	90 max	volts
Heater positive with respect to cathode	90 max	volts

<b>Characteristics:</b>			
Plate Supply Voltage	120	180	volts
Grid-No.2 Supply Voltage	120	120	volts
Cathode-Bias Resistor*	180	180	ohms
Plate Resistance (Approx.)	0.3	0.5	megohm
Transconductance	5000	5100	μmhos
Grid-No.1 Voltage for plate current of 10 μa	-8.5	-8.5	volts
Plate Current	7.5	7.7	ma
Grid-No.2 Current	2.5	2.4	ma

\* Fixed-bias operation is not recommended.

## POWER PENTODE

Miniature type used in compact equipment as a power amplifier. Outline 11, OUTLINES SECTION. Tube requires miniature seven-contact socket and may be mounted in any position. For heater and cathode considerations, refer to type 6AV6.

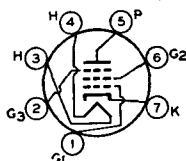

# 6AK6

<b>HEATER VOLTAGE (AC/DC)</b>	6.3	volts
<b>HEATER CURRENT</b>	0.15	ampere
<b>DIRECT INTERELECTRODE CAPACITANCES (Approx.):</b>		
Grid No. 1 to Plate	0.12	μμf
Grid No.1 to Cathode, Heater, Grid No.2, and Grid No.3	3.6	μμf
Plate to Cathode, Heater, Grid No.2, and Grid No.3	4.2	μμf

### CLASS A<sub>1</sub> AMPLIFIER

<b>Maximum Ratings:</b>	<b>Triode #</b>	<b>Pentode</b>	
<b>PLATE VOLTAGE</b>	Connection	Connection	
GRID NO. 2 (SCREEN-GRID) VOLTAGE	300 max	300 max	volts
PLATE DISSIPATION	-	300 max	volts
GRID-NO.2 INPUT	3.5 max	2.75 max	watts
<b>PEAK HEATER-CATHODE VOLTAGE:</b>	-	0.75 max	watt
Heater negative with respect to cathode	90 max	90 max	volts
Heater positive with respect to cathode	90 max	90 max	volts

### Typical Operation:

Plate Voltage	180	180	volts
Grid No. 3 (Suppressor Grid)	-	Connected to cathode	at socket

AVERAGE PLATE CHARACTERISTICS  
PENTODE CONNECTION

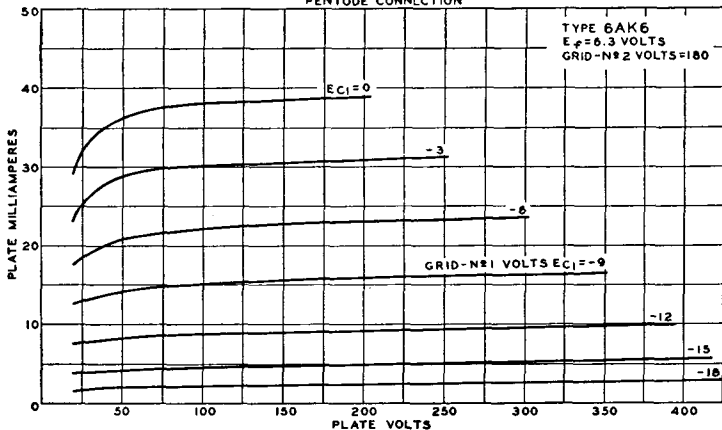

92CM-6450T

Grid-No. 2 Voltage .....	-	180	volts
Grid-No. 1 Voltage .....	-12	-9	volts
Peak AF Grid-No. 1 Voltage .....	12	9	volts
Zero-Signal Plate Current .....	12	15	ma
Zero-Signal Grid-No. 2 Current .....	-	2.5	ma
Plate Resistance .....	0.0044	0.2	megohm
Amplification Factor .....	9.3	-	-
Transconductance .....	2100	2300	$\mu$ mhos
Load Resistance .....	12000	10000	ohms
Total Harmonic Distortion .....	5	10	per cent
Maximum-Signal Power Output .....	0.26	1.1	watts

**Maximum Circuit Values:**

<b>Grid-No.1-Circuit Resistance:</b>			
For fixed-bias operation .....	0.1 max	megohm	
For cathode-bias operation .....	0.5 max	megohm	

# Grid No. 2 and grid No. 3 tied to plate.

## TWIN DIODE

Miniature, high-perveance type used as detector in FM and television circuits. It is especially useful as a ratio detector in ac-operated FM receivers. Each diode section can be used

# 6AL5

independently of the other, or the two sections can be combined in parallel or full-wave arrangement. Resonant frequency of each unit is approximately 700 megacycles per second. Outline 9, OUTLINES SECTION. Tube requires miniature seven-contact socket and may be mounted in any position. For heater and cathode considerations, refer to type 6AV6.

HEATER VOLTAGE (AC/DC) .....	6.3	volts
HEATER CURRENT .....	0.3	ampere
<b>DIRECT INTERELECTRODE CAPACITANCES:</b>		
Plate No. 1 to Cathode No. 1, Heater, and Internal Shield .....	2.5	$\mu$ f
Plate No. 2 to Cathode No. 2, Heater, and Internal Shield .....	2.5	$\mu$ f
Cathode No. 1 to Plate No. 1, Heater, and Internal Shield .....	3.4	$\mu$ f
Cathode No. 2 to Plate No. 2, Heater, and Internal Shield .....	3.4	$\mu$ f
Plate No. 1 to Plate No. 2 .....	0.068 max	$\mu$ f

## HALF-WAVE RECTIFIER

<b>Maximum Ratings:</b>		
PEAK INVERSE PLATE VOLTAGE .....	330 max	volts

AVERAGE CHARACTERISTICS  
HALF-WAVE RECTIFICATION-SINGLE DIODE

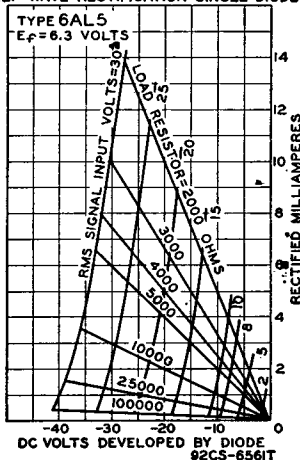

PEAK PLATE CURRENT (Per Plate).....	54 <i>max</i>	ma
DC OUTPUT CURRENT (Per Plate).....	9 <i>max</i>	ma
PEAK HEATER-CATHODE VOLTAGE:		
Heater negative with respect to cathode.....	330 <i>max</i>	volts
Heater positive with respect to cathode.....	330 <i>max</i>	volts

**Typical Operation:**

AC Plate Voltage per Plate (rms).....	117	volts
Min. Total Effective Plate-Supply Impedance.....	300	ohms
DC Output Current per Plate.....	9	ma

## ELECTRON-RAY TUBE

Glass octal type used to indicate visually on a pair of rectangular fluorescent patterns the effects of changes in voltages applied to its grid and three deflecting electrodes. It is especially useful in meeting the requirements for accurate tuning in FM receivers. Outline 18, OUTLINES SECTION. Tube requires octal socket and may be mounted in any position. Heater volts (ac/dc), 6.3; amperes, 0.15. Ratings: target

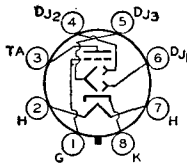

## 6AL7-GT

volts, 365 *max*, 220 *min*; peak heater-cathode volts, 90 *max*. This type is used principally for renewal purposes.

**Typical Operation:**

### INDICATOR SERVICE

Target Voltage.....	315	volts
Deflecting-Electrode-No.1 Voltage.....	0	volts
Deflecting-Electrode-No.2 Voltage.....	0	volts
Deflecting-Electrode-No.3 Voltage.....	0	volts
Cathode Resistor (Approx.).....	3300	ohms
Deflection Sensitivity (Approx.)#.....	1	mm/volt
Grid Voltage for Fluorescence Cutoff (Approx.)*.....	-7	volts

#For first millimeter of unbalance in FM application.

\*The grid should be connected to the cathode when not used for fluorescence control.

## DIODE—SHARP-CUTOFF PENTODE

Miniature types used in diversified applications in television receivers. Type 6AM8-A has a controlled heater warm-up time for use in receivers employing series-connected heater strings.

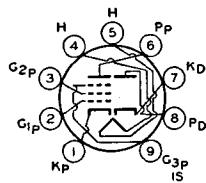

## 6AM8

## 6AM8-A

The pentode unit is used as an if amplifier, video amplifier, or agc amplifier. The high-perveance diode is used as an audio detector, video detector, or dc restorer. Outline 12, OUTLINES SECTION. Tubes require miniature nine-contact socket and may be mounted in any position.

HEATER VOLTAGE (AC/DC).....	6.3	volts
HEATER CURRENT.....	0.45	ampere
HEATER WARM-UP TIME (Average)* for 6AM8-A.....	11	seconds

\* For definition of heater warm-up time and method for determining it, see type 6CG7.

**DIRECT INTERELECTRODE CAPACITANCES:**

	<i>Without External Shield</i>	<i>With External Shield</i>	
<b>Diode Unit:</b>			
Plate to Cathode, Heater, and Internal Shield.....	1.7	2.3	$\mu\text{f}$
Cathode to Plate, Heater, and Internal Shield.....	4	4	$\mu\text{f}$
<b>Pentode Unit:</b>			
Grid No.1 to Plate.....	0.015 <i>max</i>	0.015 <i>max</i>	$\mu\text{f}$
Grid No.1 to Cathode, Heater, Grid No.2, Grid No.3, and Internal Shield.....	6	6	$\mu\text{f}$
Plate to Cathode, Heater, Grid No.2, Grid No.3, and Internal Shield.....	2.6	3.4	$\mu\text{f}$
Pentode Grid No.1 to Diode Plate.....	0.006 <i>max</i>	0.005 <i>max</i>	$\mu\text{f}$
Pentode Plate to Diode Cathode.....	0.15 <i>max</i>	0.15 <i>max</i>	$\mu\text{f}$
Pentode Plate to Diode Plate.....	0.1 <i>max</i>	0.035 <i>max</i>	$\mu\text{f}$

# RCA Receiving Tube Manual

## PENTODE UNIT AS CLASS A<sub>1</sub> AMPLIFIER

### Maximum Ratings:

PLATE VOLTAGE.....	300 max	volts
GRID-NO.3 (SUPPRESSOR) VOLTAGE.....	0 max	volts
GRID-NO.2 (SCREEN-GRID) SUPPLY VOLTAGE.....	300 max	volts
GRID-NO.2 VOLTAGE.....	See curve page 67	
GRID-NO.1 (CONTROL-GRID) VOLTAGE:		
Positive bias value.....	0 max	volts
PLATE DISSIPATION.....	2.8 max	watts
GRID-NO.2 INPUT:		
For grid-No.2 voltages up to 150 volts.....	0.5 max	watts
For grid-No.2 voltages between 150 and 300 volts.....	See curve page 67	
PEAK HEATER-CATHODE VOLTAGE:		
Heater negative with respect to cathode.....	200 max	volts
Heater positive with respect to cathode.....	200° max	volts

### Characteristics:

Plate Supply Voltage.....	200	volts
Grid No.3.....	Connected to cathode at socket	
Grid-No.2 Supply Voltage.....	150	volts
Cathode-Bias Resistor.....	120	ohms
Plate Resistance (Approx.).....	600000	ohms
Transconductance.....	7000	μmhos
Grid-No.1 Voltage (Approx.) for plate current of 10 μa.....	-8	volts
Plate Current.....	11.5	ma
Grid-No.2 Current.....	2.7	ma

### Maximum Circuit Values:

Grid-No.1-Circuit Resistance:		
For fixed-bias operation.....	0.25 max	megohm
For cathode-bias operation.....	1.0 max	megohm

## DIODE UNIT

### Maximum Ratings:

DC PLATE CURRENT.....	5 max	ma
PEAK HEATER-CATHODE VOLTAGE:		
Heater negative with respect to cathode.....	200 max	volts
Heater positive with respect to cathode.....	200° max	volts

\*The dc component must not exceed 100 volts.

AVERAGE PLATE CHARACTERISTICS  
PENTODE UNIT

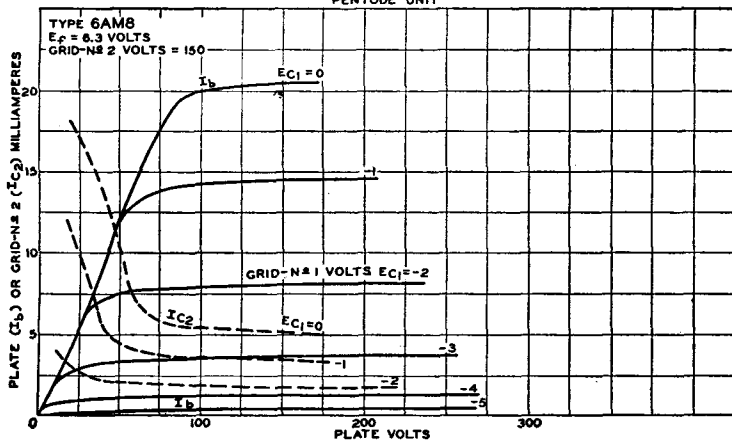

92CM-8503T

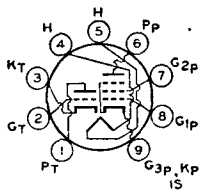

## MEDIUM-MU TRIODE— SHARP-CUTOFF PENTODE

Miniature type used in a wide variety of applications in color television receivers. The pentode unit is used as an intermediate-frequency amplifier, a video amplifier, an agc amplifier,

# 6AN8

or as a reactance tube. The triode unit is used in low-frequency oscillator, sync-separator, sync-clipper, and phase-splitter circuits. Outline 12, OUTLINES SECTION. Tube requires miniature nine-contact socket and may be mounted in any position.

HEATER VOLTAGE (AC/DC) .....	6.3	volts
HEATER CURRENT .....	0.45	ampere
DIRECT INTERELECTRODE CAPACITANCES:		
Triode Unit:		
Grid to Plate .....	1.5	$\mu$ f
Grid to Cathode and Heater .....	2.0	$\mu$ f
Plate to Cathode and Heater .....	0.27	$\mu$ f
Pentode Unit:		
Grid No.1 to Plate .....	0.04 max	$\mu$ f
Grid No.1 to Cathode, Heater, Grid No.2, Grid No.3, and Internal Shield .....	7	$\mu$ f
Plate to Cathode, Heater, Grid No.2, Grid No.3, and Internal Shield .....	2.3	$\mu$ f
Triode Grid to Pentode Plate .....	0.005	$\mu$ f
Pentode Grid No.1 to Triode Plate .....	0.006	$\mu$ f
Pentode Plate to Triode Plate .....	0.045	$\mu$ f

### CLASS A<sub>1</sub> AMPLIFIER

#### Maximum Ratings:

	Triode Unit	Pentode Unit	
PLATE VOLTAGE .....	300 max	300 max	volts
GRID-NO.2 SUPPLY VOLTAGE .....	-	300 max	volts
GRID-NO.2 (SCREEN-GRID) VOLTAGE .....	-	See curve page 67	
GRID-NO.1 (CONTROL-GRID) VOLTAGE .....	0 max	0 max	volts
PLATE DISSIPATION .....	2.6 max	2 max	watts
GRID-NO.2 INPUT:			
For grid-No.2 voltages up to 150 volts .....	-	0.5 max	watt
For grid-No.2 voltages between 150 and 300 volts .....	-	See curve page 67	
PEAK HEATER-CATHODE VOLTAGE:			
Heater negative with respect to cathode .....	200 max	200 max	volts
Heater positive with respect to cathode .....	200 <sup>o</sup> max	200 <sup>o</sup> max	volts

#### Characteristics:

Plate Supply Voltage .....	200	200	volts
Grid-No.2 Supply Voltage .....	-	150	volts
Grid-No.1 Voltage .....	-6	-	volts
Cathode-Bias Resistor .....	-	180	ohms
Amplification Factor .....	19	-	
Plate Resistance (Approx.) .....	5750	300000	ohms
Transconductance .....	3300	6200	$\mu$ hms
Grid-No.1 Voltage (Approx.) for plate current of 10 $\mu$ a .....	-19	-8	volts
Plate Current .....	13	9.5	ma
Grid-No.2 Current .....	-	2.8	ma

#### Maximum Circuit Values:

##### Grid-No.1-Circuit Resistance:\*

For fixed-bias operation .....	0.5 max	0.25 max	megohm
For cathode-bias operation .....	1.0 max	1.0 max	megohm

\*The dc component must not exceed 100 volts.

\*If either unit is operating at maximum rated conditions, grid-No.1-circuit resistance for both units should not exceed the stated values.

AVERAGE PLATE CHARACTERISTICS  
PENTODE UNIT

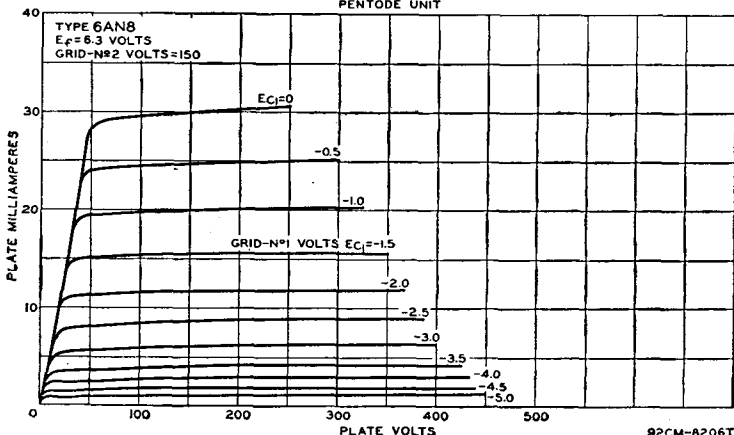

## AVERAGE PLATE CHARACTERISTICS TRIODE UNIT

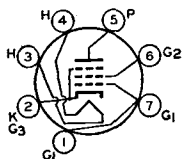
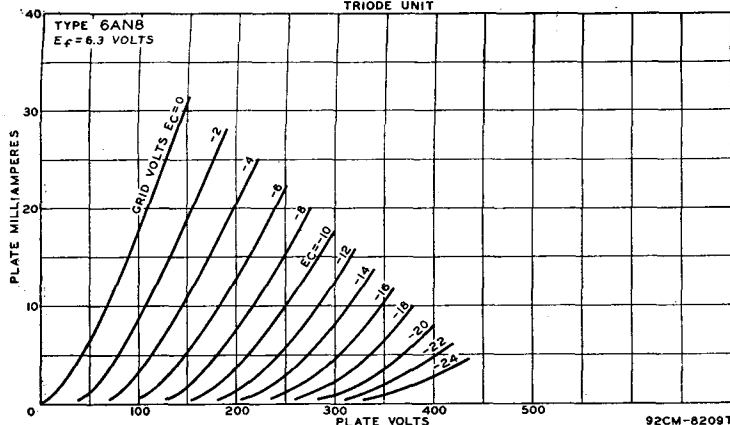

### BEAM POWER TUBE

Miniature types used as output amplifiers primarily in automobile receivers and in ac-operated receivers. Type 6AQ5-A has a controlled heater warm-up time for use in television receivers employing series-connected heater strings. Within their maximum ratings, the performance of these types is equivalent to that of larger types 6V6 and 6V6-GT. For typical circuits employing type 6AQ5, both singly and in push-pull, refer to **CIRCUIT SECTION**.

# 6AQ5 6AQ5-A

receivers employing series-connected heater strings. Within their maximum ratings, the performance of these types is equivalent to that of larger types 6V6 and 6V6-GT. For typical circuits employing type 6AQ5, both singly and in push-pull, refer to **CIRCUIT SECTION**.

HEATER VOLTAGE (AC/DC) .....	6.3	volts
HEATER CURRENT .....	0.45	ampere
HEATER WARM-UP TIME (Average)* for 6AQ5-A .....	11	seconds
DIRECT INTERELECTRODE CAPACITANCES (Approx.):		
Grid No. 1 to Plate .....	0.35	$\mu$ f
Grid No. 1 to Cathode, Heater, Grid No. 2, and Grid No. 3 .....	8.3	$\mu$ f
Plate to Cathode, Heater, Grid No. 2, and Grid No. 3 .....	8.2	$\mu$ f

\* For definition of heater warm-up time and method for determining it, see type 6CG7.

### CLASS A<sub>1</sub> AND CLASS AB<sub>1</sub> PUSH-PULL AMPLIFIER

<b>Maximum Ratings:</b>		
PLATE VOLTAGE .....	250 max	volts
GRID-NO. 2 (SCREEN-GRID) VOLTAGE .....	250 max	volts
PLATE DISSIPATION .....	12 max	watts
GRID-NO. 2 INPUT .....	2 max	watts
PEAK HEATER-CATHODE VOLTAGE:		
Heater negative with respect to cathode .....	6AQ5 90 max	volts
Heater positive with respect to cathode .....	6AQ5-A 200 max	volts
	200 <sup>a</sup> max	volts

<sup>a</sup> The dc component must not exceed 100 volts.

#### Typical Operation:

Same as for type 6V6-GT within the limitations of the maximum ratings.

#### Maximum Circuit Values:

Grid-No. 1-Circuit Resistance:		
For fixed-bias operation .....	0.1 max	megohm
For cathode-bias operation .....	0.5 max	megohm

## INSTALLATION AND APPLICATION

Type 6AQ5 requires a miniature seven-contact socket and may be mounted in any position. Outline 13, **OUTLINES SECTION**.

When the heater is operated on ac with a transformer, the winding of the transformer which supplies the heater circuit should operate the heater at the

recommended value for full-load operating conditions at average line voltage. Under any condition of operation, the heater voltage should not be allowed to vary more than 10 per cent from the rated value. When the 6AQ5 is used in automobile receivers, the heater terminals should be connected directly across the 6-volt battery.

Use of type 6AQ5 in a series string arrangement should be limited to tubes with the same heater-current rating. If it is necessary to use the 6AQ5 in series with tubes having different heater ratings, shunt resistors are required. Refer to ELECTRON TUBE INSTALLATION SECTION for additional heater considerations.

The cathode of the 6AQ5 should preferably be connected directly to the electrical mid-point of the heater circuit when the heater voltage is supplied from a transformer. When the 6AQ5 is operated in receivers employing a 6-volt storage battery for the heater supply, its cathode circuit is tied in either directly or through bias resistors to the negative side of the dc plate supply which is furnished either by the dc power line or the ac line through a rectifier. Under any circumstances, the heater-cathode voltage should be kept within ratings. If the use of a large resistor is necessary in some circuit designs, it should be bypassed by a suitable filter network or objectionable hum may develop.

In all services, precautions should be taken to insure that the dissipation rating is not exceeded with expected line-voltage variations, especially in the cases of fixed-bias operation. When the push-pull connection is used, fixed-bias values up to 10 per cent of each typical screen-grid voltage can be used without increasing distortion.

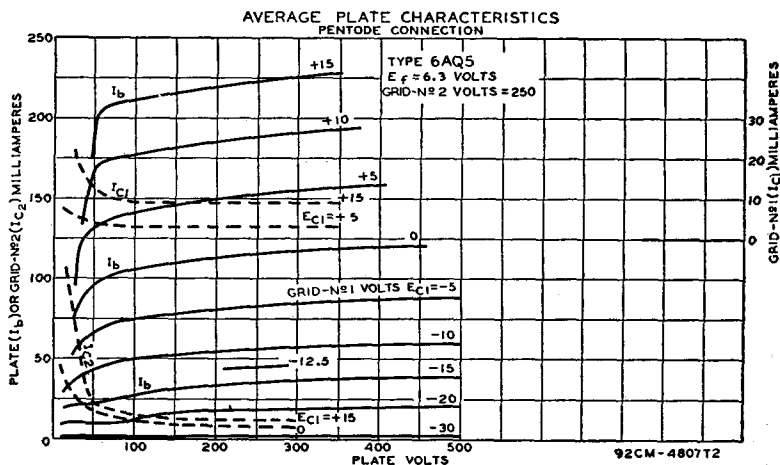

**TWIN DIODE—HIGH-MU TRIODE**

**6AQ6**

Miniature type used as a combined detector, amplifier, and avc tube in compact radio receivers. This type is similar to metal type 6Q7 in many of its electrical characteristics. Outline 11,

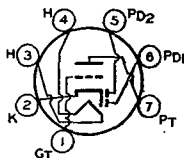

OUTLINES SECTION. Tube requires miniature seven-contact socket and may be mounted in any position. For typical operation as resistance-coupled amplifier, refer to Chart 7, RESISTANCE-COUPLED AMPLIFIER SECTION. For heater considerations, refer to type 6AV6.



HEATER VOLTAGE (AC/DC).....	6.3	volts
HEATER CURRENT.....	0.15	ampere
DIRECT INTERELECTRODE CAPACITANCES (Triode Unit):*		
Grid to Plate.....	1.8	$\mu\mu\text{f}$
Grid to Cathode and Heater.....	1.7	$\mu\mu\text{f}$
Plate to Cathode and Heater.....	1.5	$\mu\mu\text{f}$

\* With close-fitting shield connected to cathode.

### TRIODE UNIT AS CLASS A<sub>1</sub> AMPLIFIER

#### Maximum Ratings:

PLATE VOLTAGE.....	300 max	volts
PEAR HEATER-CATHODE VOLTAGE:		
Heater negative with respect to cathode.....	90 max	volts
Heater positive with respect to cathode.....	90 max	volts

#### Characteristics:

Plate Voltage.....	100	250	volts
Grid Voltage.....	-1	-3	volts
Amplification Factor.....	70	70	
Plate Resistance.....	61000	58000	ohms
Transconductance.....	1150	1200	$\mu\text{mhos}$
Plate Current.....	0.8	1.0	ma

### DIODE UNITS

Two diode plates are placed around a cathode, the sleeve of which is common to the triode unit. Diode biasing of the triode unit of the 6AQ6 is not suitable. For diode operation curves, refer to type 6AV6.

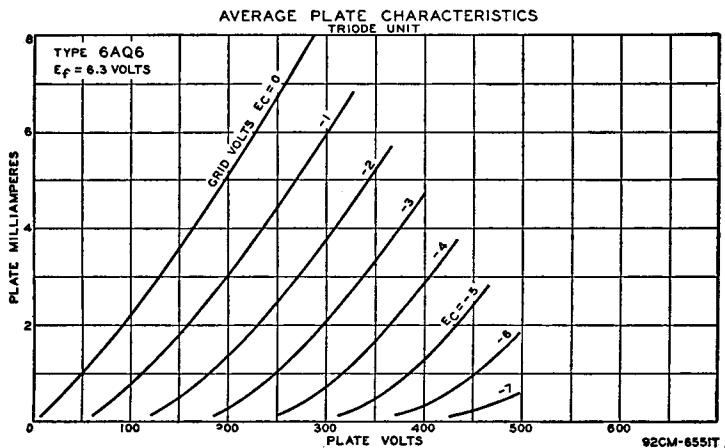

### TWIN DIODE—HIGH-MU TRIODE

Glass octal type used as FM detector and audio amplifier in circuits which require diode and triode units with separate cathodes. Outline 23, OUTLINES SECTION. Tube requires octal socket. Heater volts (ac/dc), 6.3; amperes, 0.3. Ratings and characteristics of triode unit as class A<sub>1</sub> amplifier: plate volts, 250 max; grid volts, -2; amplification factor, 70; plate resistance (approx.), 44000 ohms; transconductance,

## 6AQ7-GT

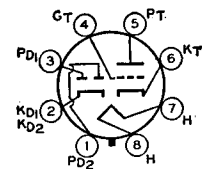

1600  $\mu\text{mhos}$ ; plate ma., 2.3. For typical operation as a resistance-coupled amplifier, refer to Chart 7, RESISTANCE-COUPLED AMPLIFIER SECTION. This type is used principally for renewal purposes.

**POWER PENTODE**

**6AR5**

Miniature type used as output tube primarily in automobile receivers and ac-operated receivers. Outline 13, OUTLINES SECTION. Tube requires miniature seven-contact socket and may be mounted in any position. Heater volts (ac/dc), 6.3; amperes, 0.4. Maximum ratings as class A<sub>1</sub> amplifier: plate and grid-No.2 (screen-grid) volts, 250 max; plate dissipation, 8.5 max watts; grid-No.2 input, 2.5 max watts;

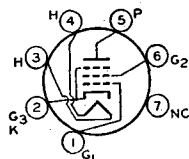

peak heater-cathode volts, 90 max. For heater and cathode considerations, refer to miniature type 6AQ5. Within its maximum ratings, type 6AR5 is equivalent in performance to glass-octal type 6K6-GT. Refer to type 6K6-GT for characteristic curves. Type 6AR5 is used principally for renewal purposes.

**Typical Operation:**

**CLASS A<sub>1</sub> AMPLIFIER**

Plate Voltage	250	250	volts
Grid-No.2 (Screen-Grid) Voltage	250	250	volts
Grid-No.1 (Control-Grid) Voltage	-16.5	-18	volts
Peak AF Grid-No.1 Voltage	16.5	18	volts
Zero-Signal Plate Current	34	32	ma
Maximum-Signal Plate Current	35	33	ma
Zero-Signal Grid-No.2 Current	5.7	5.5	ma
Maximum-Signal Grid-No.2 Current	10	10	ma
Plate Resistance (Approx.)	65000	68000	ohms
Transconductance	2400	2300	μmhos
Load Resistance	7000	7600	ohms
Total Harmonic Distortion	7	11	per cent
Maximum-Signal Power Output	3.2	3.4	watts

**Maximum Circuit Values (For maximum rated conditions):**

Grid-No.1-Circuit Resistance:			
For fixed-bias operation	0.1 max	megohm	
For cathode-bias operation	0.5 max	megohm	

**BEAM POWER TUBE**

**6AS5**

Miniature type used as output amplifier primarily in automobile and in ac-operated receivers. Outline 13, OUTLINES SECTION. Tube requires miniature seven-contact socket and may be mounted in any position.

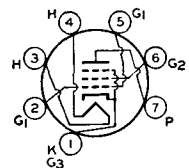

For heater and cathode considerations, refer to type 6AQ5. For curves, refer to type 35C5.

HEATER VOLTAGE (AC/DC)	6.3	volts
HEATER CURRENT	0.8	ampere
DIRECT INTERELECTRODE CAPACITANCES (Approx.):		
Grid No.1 to Plate	0.6	μμf
Grid No.1 to Cathode, Heater, Grid No.2, and Grid No.3	12	μμf
Plate to Cathode, Heater, Grid No.2, and Grid No.3	9.0	μμf

**Maximum Ratings:**

**CLASS A<sub>1</sub> AMPLIFIER**

PLATE VOLTAGE	150 max	volts
GRID-NO.2 (SCREEN-GRID) VOLTAGE	117 max	volts
PLATE DISSIPATION	5.5 max	watts
GRID-NO.2 INPUT	1.0 max	watt
PEAK HEATER-CATHODE VOLTAGE:		
Heater negative with respect to cathode	90 max	volts
Heater positive with respect to cathode	90 max	volts
BULB TEMPERATURE (At hottest point)	250 max	°C

**Typical Operation:**

Plate Voltage	150	volts
Grid-No.2 Voltage	110	volts
Grid-No.1 (Control-Grid) Voltage	-8.5	volts
Peak AF Grid-No.1 Voltage	8.5	volts
Zero-Signal Plate Current	35	ma
Maximum-Signal Plate Current	36	ma
Zero-Signal Grid-No.2 Current (Approx.)	2	ma
Maximum-Signal Grid-No.2 Current (Approx.)	6.5	ma
Transconductance	5600	μmhos
Load Resistance	4500	ohms

Total Harmonic Distortion.....	10	per cent
Maximum-Signal Power Output.....	2.2	watts

**Maximum Circuit Values (For maximum rated conditions):**

<b>Grid-No.1-Circuit Resistance:</b>		
For fixed-bias operation.....	0.1 max	megohm
For cathode-bias operation.....	0.5 max	megohm

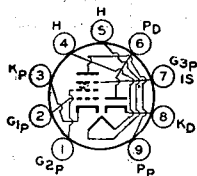

## DIODE— SHARP-CUTOFF PENTODE

# 6AS8

Miniature type used in diversified applications in television and radio receivers. The pentode unit is used as an if amplifier, video amplifier, or agc amplifier. The high-perveance diode is

used as an audio detector, video detector, or dc restorer. Outline 12, **OUTLINES SECTION**. Tube requires miniature nine-contact socket and may be mounted in any position. For curve of average plate characteristics of pentode unit, see type 6AN8.

HEATER VOLTAGE (AC/DC).....	6.3	volts
HEATER CURRENT.....	0.45	ampere
<b>DIRECT INTERELECTRODE CAPACITANCES (Approx.):</b>		
<b>Diode Unit:</b>		
Plate to Cathode, Heater, and Internal Shield.....	3.0	μf
<b>Pentode Unit:</b>		
Grid No.1 to Plate.....	0.02 max	μf
Grid No.1 to Cathode, Heater, Grid No.2, Grid No.3, and Internal Shield.....	7	μf
Plate to Cathode, Heater, Grid No.2, Grid No.3, and Internal Shield....	2.4	μf
Pentode Grid to Diode Plate.....	0.005 max	μf
Pentode Plate to Diode Cathode.....	0.15 max	μf
Pentode Plate to Diode Plate.....	0.10 max	μf

### PENTODE UNIT AS CLASS A<sub>1</sub> AMPLIFIER

**Maximum Ratings:**

PLATE VOLTAGE.....	300 max	volts
GRID-NO.3 (SUPPRESSOR-GRID) VOLTAGE.....	0 max	volts
GRID-NO.2 SUPPLY VOLTAGE.....	300 max	volts
GRID-NO.2 (SCREEN-GRID) VOLTAGE.....	See curve page 67	
GRID-NO.1 (CONTROL-GRID) VOLTAGE:		
Positive bias value.....	0 max	volts
PLATE DISSIPATION.....	2.5 max	watts
GRID-NO.2 INPUT:		
For grid-No.2 voltages up to 150 volts.....	0.5 max	watt
For grid-No.2 voltages between 150 and 300 volts.....	See curve page 67	
PEAK HEATER-CATHODE VOLTAGE:		
Heater negative with respect to cathode.....	200 max	volts
Heater positive with respect to cathode.....	200 <sup>o</sup> max	volts

**Characteristics:**

Plate Supply Voltage.....	200	volts
Grid No.3.....	Connected to cathode at socket	
Grid-No.2 Supply Voltage.....	150	volts
Cathode-Bias Resistor.....	180	ohms
Plate Resistance (Approx.).....	30000	ohms
Transconductance.....	6200	μmhos
Grid-No.1 Voltage (Approx.) for plate current of 10 μa.....	-8	volts
Plate Current.....	9.5	ma
Grid-No.2 Current.....	3	ma

**Maximum Circuit Values (For maximum rated conditions):**

<b>Grid-No.1-Circuit Resistance:</b>		
For fixed-bias operation.....	0.25 max	megohm
For cathode-bias operation.....	1.0 max	megohm

° The dc component must not exceed 100 volts.

### DIODE UNIT

**Maximum Ratings:**

PEAK INVERSE PLATE VOLTAGE.....	330 max	volts
PEAK PLATE CURRENT.....	50 max	ma
DC PLATE CURRENT.....	5 max	ma
PEAK HEATER-CATHODE VOLTAGE:		
Heater negative with respect to cathode.....	200 max	volts
Heater positive with respect to cathode.....	200 <sup>o</sup> max	volts

° The dc component must not exceed 100 volts.

# 6AT6

## TWIN DIODE—HIGH-MU TRIODE

Miniature type used as a combined detector, amplifier, and avc tube in automobile and ac-operated radio receivers. Outline 11, OUTLINES SECTION. Tube requires miniature

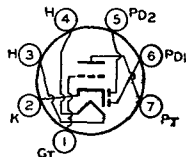

seven-contact socket and may be mounted in any position. For typical operation as resistance-coupled amplifier, refer to Chart 7, RESISTANCE-COUPLED AMPLIFIER SECTION. For heater considerations, refer to type 6AV6.

HEATER VOLTAGE (AC/DC).....	6.3	volts
HEATER CURRENT.....	0.3	ampere
DIRECT INTERELECTRODE CAPACITANCES:		
Triode Grid to Triode Plate.....	2.0	$\mu\text{f}$
Triode Grid to Cathode and Heater.....	2.2	$\mu\text{f}$
Triode Plate to Cathode and Heater.....	0.8	$\mu\text{f}$
Plate of Diode Unit No.2 to Triode Grid.....	0.04 max	$\mu\text{f}$

### Maximum Ratings: TRIODE UNIT AS CLASS A<sub>1</sub> AMPLIFIER

PLATE VOLTAGE.....	300 max	volts
PLATE DISSIPATION.....	0.5 max	watt
GRID VOLTAGE, Positive Bias Value.....	0 max	volts
PEAK HEATER-CATHODE VOLTAGE:		
Heater negative with respect to cathode.....	90 max	volts
Heater positive with respect to cathode.....	90 max	volts

### Characteristics:

Plate Voltage.....	100	250	volts
Grid Voltage.....	-1	-3	volts
Amplification Factor.....	70	70	
Plate Resistance.....	54000	58000	ohms
Transconductance.....	1300	1200	$\mu\text{mhos}$
Plate Current.....	0.8	1.0	ma

### Maximum Rating: DIODE UNITS

PLATE CURRENT (EACH UNIT).....	1.0 max	ma
--------------------------------	---------	----

The two diode plates are placed around a cathode, the sleeve of which is common to the triode unit. Each diode plate has its own base pin. For diode operation curves, refer to type 6AV6.

AVERAGE PLATE CHARACTERISTICS TRIODE UNIT

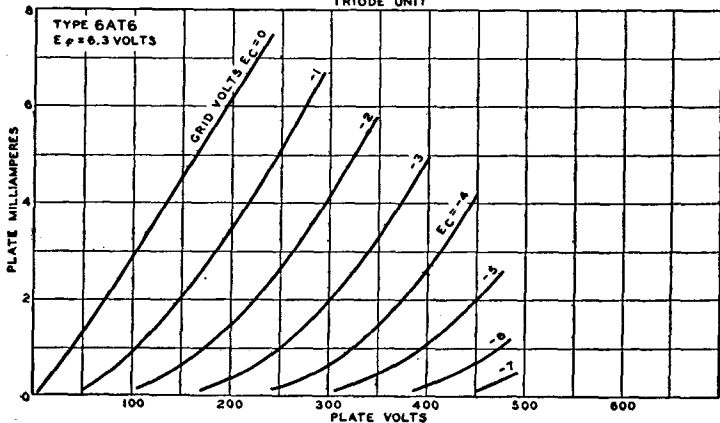

92CM-6610T

## TRIODE-PENTODE CONVERTER

Miniature types used as combined oscillator and mixer tubes in television receivers utilizing an intermediate frequency in the order of 40 megacycles per second. Type 6AT8-A has a con-

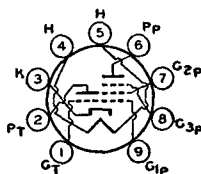

# 6AT8 6AT8-A

trolled heater warm-up time for use in receivers employing series-connected heater strings. Outline 12, OUTLINES SECTION. Except for interelectrode capacitances and basing arrangement, these types are identical with miniature type 6X8. The basing arrangement of the 6AT8 and 6AT8-A is particularly suitable for connection to the coils of certain designs of turret tuners.

HEATER VOLTAGE (AC/DC).....	6.3	volts
HEATER CURRENT.....	0.45	ampere
HEATER WARM-UP TIME (Average) <sup>■</sup> for 6AT8-A.....	11	seconds

<sup>■</sup> For definition of heater warm-up time and method for determining it, see type 6CG7.

DIRECT INTERELECTRODE CAPACITANCES (Approx.):	Without External Shield	With External Shield	
<b>Triode Unit:</b>			
Grid to Plate.....	1.5	1.5	$\mu\text{f}$
Grid to Cathode and Heater.....	2.0	2.4	$\mu\text{f}$
Plate to Cathode and Heater.....	0.5	1.0	$\mu\text{f}$
<b>Pentode Unit:</b>			
Grid No.1 to Plate.....	0.025 max	0.016 max	$\mu\text{f}$
Grid No.1 to Cathode, Heater, Grid No.2, and Grid No.3.....	4.5	4.7	$\mu\text{f}$
Plate to Cathode, Heater, Grid No.2, and Grid No.3.....	0.9	1.6	$\mu\text{f}$
Pentode Grid No.1 to Triode Plate.....	0.05 max	0.04 max	$\mu\text{f}$
Pentode Plate to Triode Plate.....	0.05 max	0.007 max	$\mu\text{f}$
Heater to Cathode.....	6.5	6.5	$\mu\text{f}$
<b>Pentode Unit Connected as Triode*:</b>			
Grid No.1 to Plate.....	1.3	1.3	$\mu\text{f}$
Grid No.1 to Cathode and Heater.....	3.0	3.3	$\mu\text{f}$
Plate to Cathode and Heater.....	1.7	2.5	$\mu\text{f}$

\* Grid No.3 connected to cathode; grid No.2 connected to plate.

## HALF-WAVE VACUUM RECTIFIER

Glass octal types used as damper tubes in horizontal-deflection circuits of color television receivers and of television receivers utilizing picture tubes having wide-angle deflection. Outline

### 6AU4-GT

### 6AU4-GTA

29, OUTLINES SECTION. Tubes require octal socket and may be mounted in any position. These types may be supplied with pin No.1 omitted. It is especially important that these tubes, like other power-handling tubes, be adequately ventilated. Type 6AU4-GT is a DISCONTINUED type listed for reference only. For curve of average plate characteristics for 6AU4-GTA, see page 64.

HEATER VOLTAGE (AC/DC).....	6.3	volts
HEATER CURRENT.....	1.8	amperes
<b>DIRECT INTERELECTRODE CAPACITANCES (Approx.):</b>		
Plate to Heater and Cathode.....	8.5	$\mu\text{f}$
Cathode to Heater and Plate.....	11.5	$\mu\text{f}$
Heater to Cathode.....	4.0	$\mu\text{f}$

### DAMPER SERVICE

*For operation in a 525-line, 30-frame system*

<b>Maximum Ratings:</b>	<b>6AU4-GT</b>	<b>6AU4-GTA</b>	
PEAK INVERSE PLATE VOLTAGE† (Absolute Maximum).....	4500 <sup>o</sup> max	4500 <sup>o</sup> max	volts
PEAK PLATE CURRENT.....	1050 max	1150 max	ma
DC PLATE CURRENT.....	175 max	190 max	ma
PLATE DISSIPATION.....	6 max	6 max	watts
<b>PEAK HEATER-CATHODE VOLTAGE:</b>			
Heater negative with respect to cathode (Absolute Maximum).....	4500 <sup>o</sup> *max	4500 <sup>o</sup> *max	volts
Heater positive with respect to cathode.....	300 <sup>#</sup> max	300 <sup>#</sup> max	volts

† The duration of the voltage pulse must not exceed 15 per cent of one horizontal scanning cycle. In a 525-line, 30-frame system, 15 per cent of one horizontal scanning cycle is 10 microseconds.

<sup>o</sup> Under no circumstances should this absolute value be exceeded.

\* The dc component must not exceed 900 volts.

# The dc component must not exceed 100 volts.

## BEAM POWER TUBE

Glass octal type used as horizontal deflection amplifier in low-cost, high-efficiency deflection circuits of television receivers employing either transformer coupling or direct coupling to

### 6AU5-GT

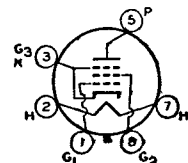
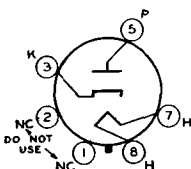

the deflecting yoke. Outline 22, OUTLINES SECTION. Tube requires octal socket and may be mounted in any position.

HEATER VOLTAGE (AC/DC).....	6.3	volts
HEATER CURRENT.....	1.25	amperes
DIRECT INTERELECTRODE CAPACITANCES (Approx.):		
Grid No.1 to Plate.....	0.5	$\mu\text{f}$
Grid No.1 to Cathode, Heater, Grid No.2, and Grid No.3.....	11.3	$\mu\text{f}$
Plate to Cathode, Heater, Grid No.2, and Grid No.3.....	7.0	$\mu\text{f}$
TRANSCONDUCTANCE#.....	5600	$\mu\text{mhos}$
MU-FACTOR, Grid No.2 to Grid No.1†.....	5.9	
# For plate volts, 115; grid-No.2 volts, 175; grid-No.1 volts, -20.		
† For plate volts, 100; grid-No.2 volts, 100; grid-No.1 volts, -4.5.		

### HORIZONTAL DEFLECTION AMPLIFIER

*For operation in a 525-line, 30-frame system*

<b>Maximum Ratings:</b>		
DC PLATE VOLTAGE.....	550 max	volts
PEAK POSITIVE-PULSE PLATE VOLTAGE* (Absolute Maximum).....	5500 <sup>o</sup> max	volts
PEAK NEGATIVE-PULSE PLATE VOLTAGE.....	-1250 max	volts
DC GRID-NO.2 (SCREEN-GRID) VOLTAGE.....	200 max	volts
PEAK NEGATIVE-PULSE GRID-NO.1 (CONTROL-GRID) VOLTAGE.....	-300 max	volts
CATHODE CURRENT:		
Peak.....	400 max	ma
Average.....	110 max	ma
GRID-NO.2 INPUT.....	2.5 max	watts
PLATE DISSIPATION††.....	10 max	watts
PEAK HEATER-CATHODE VOLTAGE:		
Heater negative with respect to cathode.....	200 max	volts
Heater positive with respect to cathode.....	200 <sup>o</sup> max	volts
BULB TEMPERATURE (At hottest point).....	210 max	°C

**Maximum Circuit Value:**

Grid-No.1-Circuit Resistance..... 0.47 max megohm

\* The duration of the voltage pulse must not exceed 15 per cent of one horizontal scanning cycle. In a 525-line, 30-frame system, 15 per cent of one horizontal scanning cycle is 10 microseconds.

<sup>o</sup> Under no circumstances should this absolute value be exceeded.

† Preferably obtained through a series dropping resistor of sufficient magnitude to limit the grid-No.2 input to the rated maximum value.

†† An adequate bias resistor or other means is required to protect the tube in the absence of excitation.

■ The dc component must not exceed 100 volts.

### VOLTAGE REGULATOR SERVICE

*Triode Connection, Grid No.2 connected to Plate*

<b>Maximum Ratings:</b>		
PLATE VOLTAGE.....	300 max	volts
GRID-NO.1 VOLTAGE:		
Negative bias value.....	-125 max	volts
Positive bias value.....	0 max	volts
CATHODE CURRENT.....	110 max	ma
TOTAL PLATE AND GRID-NO.2 DISSIPATION.....	10 max	watts
PEAK HEATER-CATHODE VOLTAGE:		
Heater negative with respect to cathode.....	180 max	volts
Heater positive with respect to cathode.....	180 max	volts

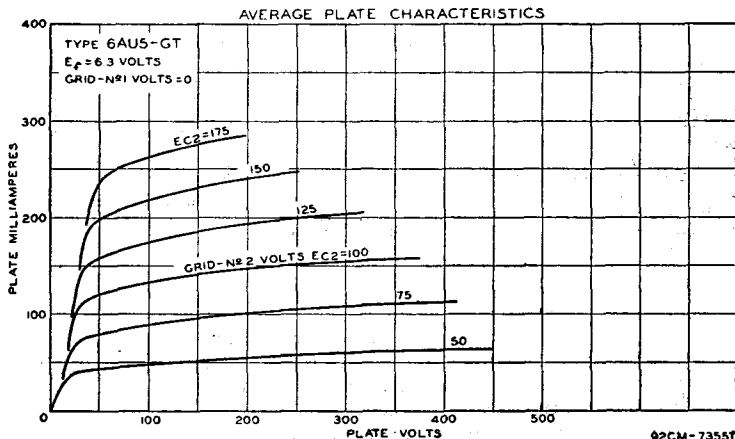

92CM-7355T

AVERAGE CHARACTERISTICS

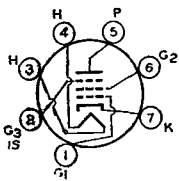
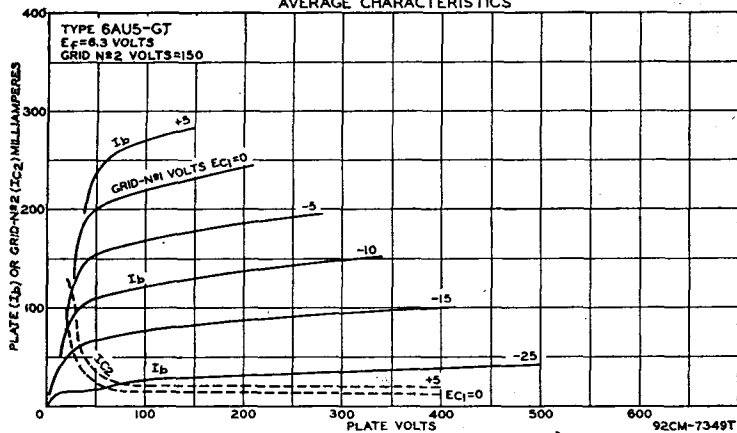

## SHARP-CUTOFF PENTODE

Miniature type used in compact radio equipment as an rf amplifier especially in high-frequency, wide-band applications. It is also used as a limiter tube in FM equipment. Outline 11,

# 6AU6

**OUTLINES SECTION.** Tube requires miniature seven-contact socket and may be mounted in any position. For a discussion of limiters, refer to **ELECTRON TUBE APPLICATIONS SECTION**. For typical operation as resistance-coupled amplifier, refer to Chart 8, **RESISTANCE-COUPLED AMPLIFIER SECTION**. For heater and cathode considerations, refer to type 6AV6.

HEATER VOLTAGE (AC/DC) .....	6.3	volts
HEATER CURRENT .....	0.3	ampere
<b>DIRECT INTERELECTRODE CAPACITANCES:</b>		
Grid No.1 to Plate .....	0.0035 max	μf
Grid No.1 to Cathode, Heater, Grid No.2, Grid No.3, and Internal Shield .....	5.5	μf
Plate to Cathode, Heater, Grid No.2, Grid No.3, and Internal Shield .....	5.0	μf

### CLASS A<sub>1</sub> AMPLIFIER

**Maximum Ratings:**

	Triode† Connection	Pentode Connection	
PLATE VOLTAGE .....	250 max	300 max	volts
GRID-NO.2 (SCREEN-GRID) VOLTAGE .....	-	See curve page 67	
GRID-NO.2 SUPPLY VOLTAGE .....	-	300 max	volts
PLATE DISSIPATION .....	3.2 max	3 max	watts
<b>GRID-NO.2 INPUT:</b>			
For grid-No.2 voltages up to 150 volts .....		0.65 max	watt
For grid-No.2 voltages between 150 and 300 volts .....		See curve page 67	
<b>GRID-NO.1 (CONTROL-GRID) VOLTAGE:</b>			
Negative bias value .....	50 max	50 max	volts
Positive bias value .....	0 max	0 max	volts
<b>PEAK HEATER-CATHODE VOLTAGE:</b>			
Heater negative with respect to cathode .....	90 max	90 max	volts
Heater positive with respect to cathode .....	90 max	90 max	volts

**Characteristics: (Pentode Connection):**

Plate Supply Voltage .....	100	250	250	
Grid No.3 (Suppressor Grid) .....	Connected to cathode at socket			volts
Grid-No.2 Supply Voltage .....	100	125	150	volts
Cathode-Bias Resistor .....	150	100	68	ohms
Plate Resistance (Approx.) .....	0.5	1.5	1.0	megohms
Transconductance .....	3900	4500	5200	μmhos
Grid-No.1 Voltage for plate current of 10 μa .....	-4.2	-5.5	-6.5	volts
Plate Current .....	5.0	7.6	10.6	ma
Grid-No. 2 Current .....	2.1	3.0	4.3	ma

## Characteristics: (Triode Connection):†

Plate Supply Voltage .....	250	volts
Cathode-Bias Resistor .....	330	ohms
Amplification Factor .....	36	
Plate Resistance .....	7500	ohms
Transconductance .....	4800	μmhos
Plate Current .....	12.2	ma

† Grid No. 2 and grid No. 3 tied to plate.

## AVERAGE PLATE CHARACTERISTICS PENTODE CONNECTION

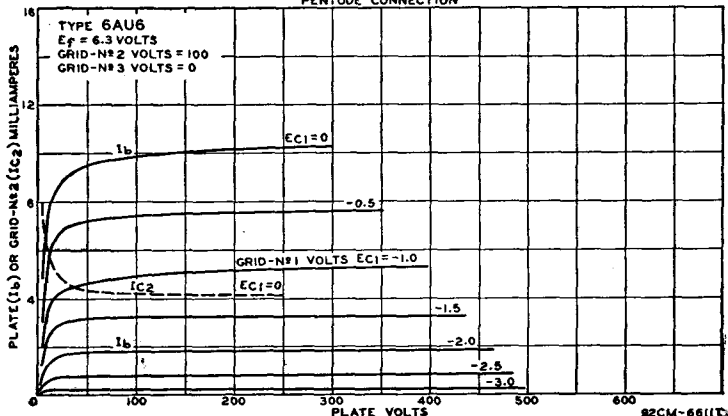

## MEDIUM-MU TWIN TRIODE

### 6AU7

Miniature type used as phase inverter or amplifier in television receivers employing series-connected heater strings. Outline 12, OUTLINES SECTION. Heater volts (ac/dc), 12.6 (series), 6.3 (parallel); amperes, 0.15 (series), 0.3 (parallel); warm-up time (average) in parallel arrangement, 11 seconds. For definition of heater warm-up time and method for determining it, see type 6CG7. Peak heater-cathode volts, 200 max. When the heater is positive with respect to the cathode, the dc component of the heater-cathode voltage must not exceed 100 volts. Except for heater and heater-cathode ratings, type 6AU7 is identical with miniature type 12AU7. The 6AU7 is a DISCONTINUED type listed for reference only.

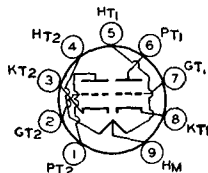

ing it, see type 6CG7. Peak heater-cathode volts, 200 max. When the heater is positive with respect to the cathode, the dc component of the heater-cathode voltage must not exceed 100 volts. Except for heater and heater-cathode ratings, type 6AU7 is identical with miniature type 12AU7. The 6AU7 is a DISCONTINUED type listed for reference only.

## MEDIUM-MU TRIODE— SHARP-CUTOFF PENTODE

### 6AU8

Miniature type used in a wide variety of applications in television receivers employing series-connected heater strings. The pentode unit is used as a video amplifier, an if amplifier,

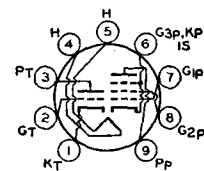

or an agc amplifier. The triode unit is used in sync-amplifier, sync-separator, sync-clipper, and phase-inverter circuits. Outline 14, OUTLINES SECTION. Tube requires miniature nine-contact socket and may be mounted in any position.

HEATER VOLTAGE (AC/DC) .....	6.3	volts
HEATER CURRENT .....	0.6	ampere
HEATER WARM-UP TIME (Average)* .....	11	seconds

#### DIRECT INTERELECTRODE CAPACITANCES:

##### Triode Unit:

Grid to Plate .....	2.2	μf
Grid to Cathode and Heater .....	2.6	μf
Plate to Cathode and Heater .....	0.34	μf

##### Pentode Unit:

Grid No.1 to Plate .....	0.044	μf
Grid No.1 to Cathode, Heater, Grid No.2, Grid No.3, and Internal Shield .....	7.5	μf
Plate to Cathode, Heater, Grid No.2, Grid No.3, and Internal Shield....	2.4	μf



Triode Grid to Pentode Plate .....	0.022 max	$\mu\mu\text{l}$
Pentode Grid No.1 to Triode Plate .....	0.006 max	$\mu\mu\text{l}$
Pentode Plate to Triode Plate .....	0.12 max	$\mu\mu\text{l}$

\* For definition of heater warm-up time and method for determining it, see type 6CG7.

## CLASS A<sub>1</sub> AMPLIFIER

### Maximum Ratings:

	Triode Unit	Pentode Unit	
PLATE VOLTAGE .....	300 max	300 max	volts
GRID-NO.2 (SCREEN-GRID) SUPPLY VOLTAGE .....	-	300 max	volts
GRID-NO.2 VOLTAGE .....	-	See curve page 67	
GRID-NO.1 (CONTROL-GRID) VOLTAGE:			
Positive bias value .....	0 max	0 max	volts
PLATE DISSIPATION .....	2.5 max	3 max	watts
GRID-NO.2 INPUT:			
For grid-No.2 voltages up to 150 volts .....	-	1 max	watt
For grid-No.2 voltages between 150 and 300 volts .....	-	See curve page 67	
PEAK HEATER-CATHODE VOLTAGE:			
Heater negative with respect to cathode .....	200 max	200 max	volts
Heater positive with respect to cathode .....	200 <sup>m</sup> max	200 <sup>m</sup> max	volts

### Characteristics:

Plate Supply Voltage .....	150	200	volts
Grid-No.2 Supply Voltage .....	-	125	volts
Cathode-Bias Resistor .....	150	82	ohms

### AVERAGE CHARACTERISTICS

#### PENTODE UNIT

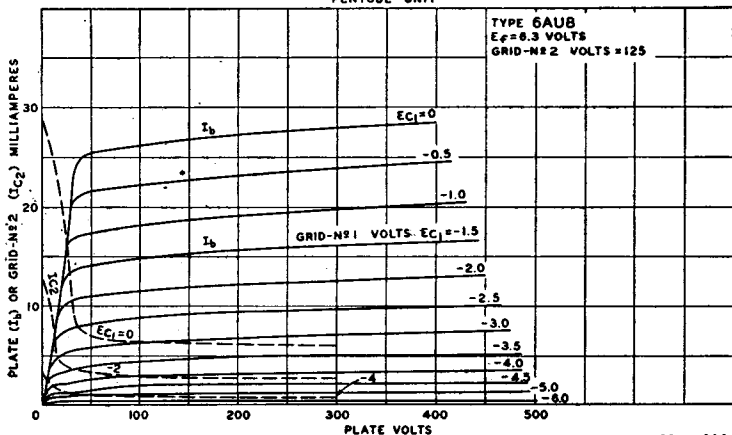

92CM-8804T

### AVERAGE CHARACTERISTICS

#### TRIODE UNIT

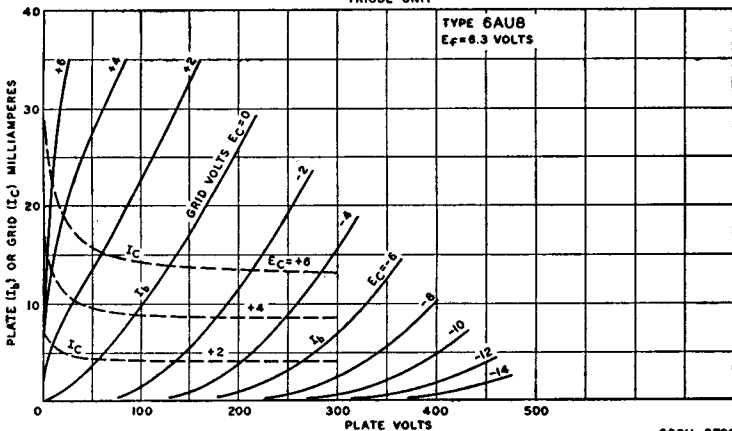

92CM-8796T

Amplification Factor.....	40	—	
Plate Resistance (Approx.).....	8200	150000	ohms
Transconductance.....	4900	7000	μmhos
Grid-No.1 Voltage (Approx.) for plate current of 100 μa.....	-6.5	-8	volts
Plate Current.....	9	15	ma
Grid-No.2 Current.....	—	3.4	ma

**Maximum Circuit Values:**

Grid-No.1-Circuit Resistance:			
For fixed-bias operation.....	0.5 max	0.25 max	megohm
For cathode-bias operation.....	1.0 max	1.0 max	megohm

■ The dc component must not exceed 100 volts.

## 6AV5-GA

## 6AV5-GT

### BEAM POWER TUBE

Glass octal types used as horizontal deflection amplifiers in television receivers employing either transformer coupling or direct coupling to the deflecting yoke. 6AV5-GA

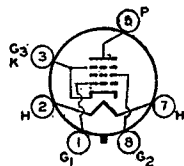

Outline 33, 6AV5-GT Outline 22 or 23, **OUTLINES SECTION**. Tubes require octal socket and may be mounted in any position. Type 6AV5-GT is a **DISCONTINUED** type listed for reference only.

HEATER VOLTAGE (AC/DC).....	6.3	volts
HEATER CURRENT.....	1.2	amperes
TRANSCONDUCTANCE*.....	5500	μmhos
MU FACTOR, Grid No.2 to Grid No.1**.....	4.3	

\* Plate volts, 250; grid-No.2 volts, 150; grid-No.1 volts, -22.5.  
 \*\* Triode connected; plate and grid-No.2 volts, 150; grid-No.1 volts, -22.5.

### HORIZONTAL DEFLECTION AMPLIFIER

*For operation in a 525-line, 30-frame system*

**Maximum Ratings:**

DC PLATE VOLTAGE.....	550 max	volts
PEAK POSITIVE-PULSE PLATE VOLTAGE † (Absolute Maximum).....	5500 <sup>o</sup> max	volts
PEAK NEGATIVE-PULSE PLATE VOLTAGE.....	-1250 max	volts
DC GRID-NO.2 (SCREEN-GRID) VOLTAGE.....	175 max	volts
PEAK NEGATIVE-PULSE GRID-NO.1 (CONTROL-GRID) VOLTAGE †.....	-300 max	volts
CATHODE CURRENT:		
Peak.....	400 max	ma
Average.....	110 max	ma
GRID-NO.2 INPUT.....	2.5 max	watts
PLATE DISSIPATION ††.....	11 max	watts
PEAK HEATER-CATHODE VOLTAGE:		
Heater negative with respect to cathode.....	200 max	volts
Heater positive with respect to cathode.....	200 <sup>o</sup> max	volts
BULB TEMPERATURE (At hottest point).....	210 max	°C

**Maximum Circuit Value (For maximum rated conditions):**

Grid-No.1 Circuit Resistance.....	0.47 max	megohm
-----------------------------------	----------	--------

† The duration of the voltage pulse must not exceed 15 per cent of one horizontal scanning cycle. In a 525-line, 30-frame system, 15 per cent of one horizontal scanning cycle is 10 microseconds.

<sup>o</sup> Under no circumstances should this absolute value be exceeded.

†† An adequate bias resistor or other means is required to protect the tube in the absence of excitation.

■ The dc component must not exceed 100 volts.

### TWIN DIODE— HIGH-MU TRIODE

## 6AV6

Miniature type used as combined detector, amplifier, and avc tube in automobile and ac-operated radio receivers. The 6AV6 may be substituted directly for the 6AT6 in applications where the higher amplification of the 6AV6 is advantageous.

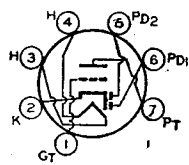

HEATER VOLTAGE (AC/DC).....	6.3	volts
HEATER CURRENT.....	0.3	ampere
DIRECT INTERELECTRODE CAPACITANCES:		
Triode Grid to Triode Plate.....	2.0	μμf
Triode Grid to Cathode and Heater.....	2.2	μμf

Triode Plate to Cathode and Heater .....	0.8	$\mu$ f
Plate of Diode Unit No.2 to Triode Grid .....	0.04 max	$\mu$ f

**Maximum Ratings:**

**TRIODE UNIT AS CLASS A<sub>1</sub> AMPLIFIER**

PLATE VOLTAGE .....	300 max	volts
GRID VOLTAGE, Positive Bias Value .....	0 max	volts
PLATE DISSIPATION .....	0.5 max	watt
<b>PEAK HEATER-CATHODE VOLTAGE:</b>		
Heater negative with respect to cathode .....	90 max	volts
Heater positive with respect to cathode .....	90 max	volts

**Characteristics:**

Plate Voltage .....	100	250	volts
Grid Voltage .....	-1	-2	volts
Amplification Factor .....	100	100	
Plate Resistance .....	80000	62500	ohms
Transconductance .....	1250	1600	$\mu$ mhos
Plate Current .....	0.50	1.2	ma

**DIODE UNITS**

**Maximum Rating:**

PLATE CURRENT (Each Unit) .....	1.0 max	ma
---------------------------------	---------	----

The two diode plates are placed around a cathode, the sleeve of which is common to the triode unit. Each diode plate has its own base pin. Diode biasing of the triode unit is not recommended.

## INSTALLATION AND APPLICATION

Type 6AV6 requires miniature seven-contact socket and may be mounted in any position. Outline 11, OUTLINES SECTION.

When the heater is operated on ac with a transformer, the winding of the transformer which supplies the heater circuit should operate the heater at the recommended value for full-load operating conditions at average line voltage. Under any condition of operation, the heater voltage should not be allowed to rise more than 10 per cent above the rated value. When the 6AV6 is used in automobile receivers, the heater terminals should be connected directly across a 6-volt battery.

In receivers that employ a series-heater connection, the heater of the 6AV6 may be operated in series with the heater of other types having the same heater-current rating. The current in the heater circuit of the 6AV6 should be adjusted to the rated value for the normal supply voltage. Refer to ELECTRON TUBE INSTALLATION SECTION, *Filament and Heater Power Supply*, for a discussion of arrangement of heaters in series-heater or "string" connection.

The cathode of the 6AV6 when operated from a transformer should preferably be connected directly to the electrical mid-point of the heater circuit. When operated in receivers employing a 6-volt storage battery for the heater supply, the cathode circuit is tied in either directly or through bias resistors to the negative side of the dc plate supply which is furnished either by the dc power line or the ac line through a rectifier. In circuits where the cathode is not connected directly to the heater, such as in a series-heater connection, the voltage difference between the heater and cathode should be kept within the tube ratings. If the use of a large resistor is necessary between the heater and cathode in some circuit designs, it should be bypassed by a suitable filter network or objectionable hum may develop.

The triode unit of the 6AV6 is recommended for use only in resistance-coupled circuits. Refer to the RESISTANCE-COUPLED AMPLIFIER SECTION, Chart 20 for typical operating conditions.

Grid bias for the triode unit of the 6AV6 may be obtained from a fixed source, such as a fixed-voltage tap on the dc power supply, or from a cathode-bias resistor.

AVERAGE DIODE CHARACTERISTICS  
HALF-WAVE RECTIFICATION-SINGLE DIODE UNIT

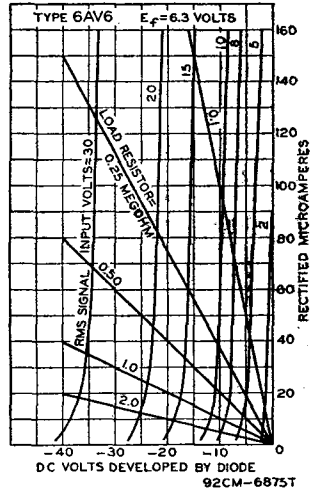

It should not be obtained by the diode-biasing method because of the probability of plate-current cutoff, even with relatively small signal voltages applied to the diode circuit.

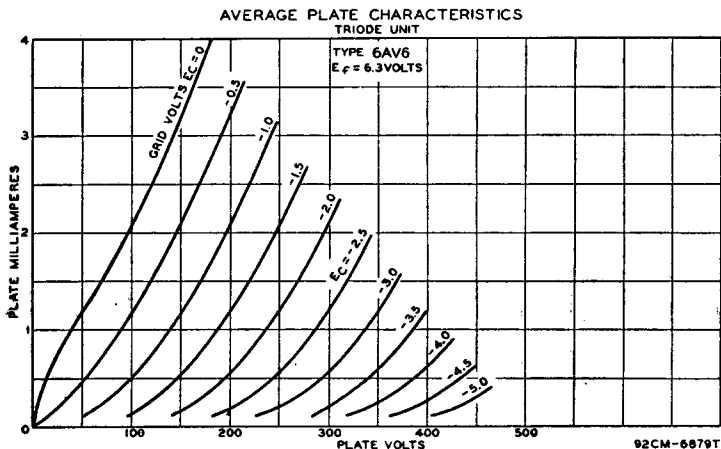

## HIGH-MU TRIODE— SHARP-CUTOFF PENTODE

# 6AW8 6AW8-A

Miniature types used in a wide variety of applications in television receivers employing series-connected heater strings. The pentode unit is used as an if amplifier, video amplifier,

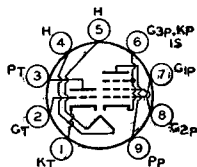

agc amplifier, or reactance tube. The triode unit is used in low-frequency oscillator, sync-separator, sync-clipper, and phase-splitter circuits. Outline 14, OUTLINES SECTION. Tubes require miniature nine-contact socket and may be mounted in any position.

HEATER VOLTAGE (AC/DC) .....	6.3	volts
HEATER CURRENT .....	0.6	ampere
HEATER WARM-UP TIME (AVERAGE)* .....	11	seconds

\*For definition of heater warm-up time and method for determining it, see type 6CG7.

### DIRECT INTERELECTRODE CAPACITANCES:

	6AW8	6AW8-A	
<b>Triode Unit:</b>			
Grid to Plate .....	2.2	2.2	$\mu\mu\text{f}$
Grid to Cathode and Heater .....	3.2	3.2	$\mu\mu\text{f}$
Plate to Cathode and Heater .....	0.32	0.32	$\mu\mu\text{f}$
<b>Pentode Unit:</b>			
Grid No.1 to Plate .....	0.036 max	0.04 max	$\mu\mu\text{f}$
Grid No.1 to Cathode, Heater, Grid No.2, Grid No.3, and Internal Shield .....	11	10	$\mu\mu\text{f}$
Plate to Cathode, Heater, Grid No.2, Grid No.3, and Internal Shield .....	2.8	3.6	$\mu\mu\text{f}$
Triode Grid to Pentode Plate .....	0.08 max	0.016 max	$\mu\mu\text{f}$
Pentode Grid No.1 to Triode Plate .....	0.008 max	0.006 max	$\mu\mu\text{f}$
Pentode Plate to Triode Plate .....	0.2 max	0.15 max	$\mu\mu\text{f}$

### CLASS A, AMPLIFIER

	Triode Unit	Pentode Unit	
Maximum Ratings:			
PLATE VOLTAGE .....	300 max	300 max	volts
GRID-NO.2 (SCREEN-GRID) SUPPLY VOLTAGE .....	-	300 max	volts
GRID-NO.2 VOLTAGE .....	-	See curve page 67	

**GRID-NO.1 (CONTROL-GRID) VOLTAGE:**

Negative bias value.....	-	50 max	volts
Positive bias value.....	-	0 max	volts
PLATE DISSIPATION (6AW8).....	1 max	3 max	watts
PLATE DISSIPATION (6AW8-A).....	1 max	3.25 max	watts

**GRID-NO.2 INPUT:**

For grid-No.2 voltages up to 150 volts.....	-	1 max	watt
For grid-No.2 voltages between 150 and 300 volts.....	-	See curve page 67	

**PEAK HEATER-CATHODE VOLTAGE:**

Heater negative with respect to cathode.....	200 max	200 max	volts
Heater positive with respect to cathode.....	200°max	200°max	volts

**Characteristics:**

Plate Supply Voltage.....	200	200	volts
Grid-No.2 Supply Voltage.....	-	150	volts
Grid-No.1 Voltage.....	-2	0	volts
Cathode-Bias Resistor.....	-	180	ohms
Amplification Factor.....	70	-	
Plate Resistance (Approx.).....	17500	400000	ohms
Transconductance.....	4000	9000	μmhos
Grid-No.1 Voltage (Approx.) for plate current of 10 μa.....	-5	-10	volts
Plate Current.....	4	13	ma
Grid-No.2 Current.....	-	3.5	ma

**Maximum Circuit Values:**
**Grid-No.1-Circuit Resistance:**

For fixed-bias operation.....	0.5 max	0.25 max	megohm
For cathode-bias operation.....	1.0 max	1.0 max	megohm

°The dc component must not exceed 100 volts.

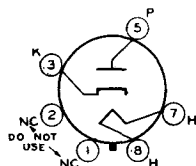

## HALF-WAVE VACUUM RECTIFIER

Glass octal type used as a damper tube in horizontal deflection circuits of television receivers. Outline 22, OUT-LINES SECTION. This type may be supplied with pin No.1 omitted. Tube

# 6AX4-GT

requires octal socket and may be mounted in any position. It is especially important that this tube, like other power-handling tubes, be adequately ventilated. For curve of average plate characteristics, see page 64.

HEATER VOLTAGE (AC/DC).....	6.3	volts
HEATER CURRENT.....	1.2	amperes

### DAMPER SERVICE

**Maximum Ratings:**

*For operation in a 525-line, 30-frame system*

PEAK INVERSE PLATE VOLTAGE# (Absolute Maximum).....	4400* max	volts
PEAK PLATE CURRENT.....	750 max	ma
DC PLATE CURRENT.....	125 max	ma
PEAK HEATER-CATHODE VOLTAGE:		
Heater negative with respect to cathode.....	4400*max	volts
Heater positive with respect to cathode.....	300 • max	volts

# The duration of the voltage pulse must not exceed 15 per cent of one horizontal scanning cycle. In a 525-line, 30-frame system, 15 per cent of one horizontal scanning cycle is 10 microseconds.

\* Under no circumstances should this absolute value be exceeded.

• The dc component must not exceed 900 volts.

• The dc component must not exceed 100 volts.

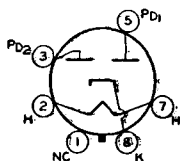

## FULL-WAVE VACUUM RECTIFIER

Glass octal type used in power supply of radio equipment having moderate dc requirements. The heater of this tube can be operated from the same transformer winding that supplies other 6.3-volt tubes in the receiver. In addition, because its heater-cathode construction gives the same heating time as that of other heater-cathode types in the receiver, use of the 6AX5-GT prevents excessive voltages from appearing

# 6AX5-GT

plies other 6.3-volt tubes in the receiver. In addition, because its heater-cathode construction gives the same heating time as that of other heater-cathode types in the receiver, use of the 6AX5-GT prevents excessive voltages from appearing

across filter capacitors during warmup, and, as a result, permits the use of electrolytic filter capacitors having lower peak voltage ratings than required for a filament-type rectifier tube.

HEATER VOLTAGE (AC).....	6.3	volts
HEATER CURRENT.....	1.2	amperes

## FULL-WAVE RECTIFIER

### Maximum Ratings:

PEAK INVERSE PLATE VOLTAGE.....	1250 max	volts
PEAK PLATE CURRENT (Per Plate).....	375 max	ma
HOT-SWITCHING TRANSIENT PLATE CURRENT		
For duration of 0.2 second maximum.....	2.6 max	amperes
AC PLATE SUPPLY VOLTAGE (Per Plate, rms).....	See Rating Chart	
DC OUTPUT CURRENT (Per Plate, rms).....	See Rating Chart	
PEAK HEATER-CATHODE VOLTAGE:		
Heater negative with respect to cathode.....	450 max	volts
Heater positive with respect to cathode.....	450 max	volts

### Typical Operation with Capacitor Input to Filter:

AC Plate-to-Plate Supply Voltage (rms).....	700	900	volts
Filter Input Capacitor*.....	10	10	μf
Effective Plate-Supply Impedance Per Plate.....	50	105	ohms
DC Output Voltage at Input to Filter (Approx.):			
At half-load current of { 62.5 ma.....	395	-	volts
{ 40 ma.....	-	540	volts
At full-load current of { 125 ma.....	350	-	volts
{ 80 ma.....	-	490	volts
Voltage Regulation (Approx.):			
Half-load to full-load current.....	45	50	volts

### Typical Operation with Choke Input to Filter:

AC Plate-to-Plate Supply Voltage (rms).....	700	900	volts
Filter Input Choke.....	10 #	10 # #	henries
DC Output Voltage at Input to Filter (Approx.):			
At half-load current of { 75 ma.....	270	-	volts
{ 62.5 ma.....	-	365	volts
At full-load current of { 150 ma.....	250	-	volts
{ 125 ma.....	-	350	volts
Voltage Regulation (Approx.):			
Half-load to full-load current.....	20	15	volts

\* Higher values of capacitance than indicated may be used but the effective plate-supply impedance may have to be increased to prevent exceeding the maximum rating for hot-switching transient plate current.

# This value is adequate to maintain optimum regulation in the region to the right of line L=10H on curve OPERATION CHARACTERISTICS With Choke Input to Filter, provided the load current is not less than 30 ma. For load currents less than 30 ma, a larger value of inductance is required for optimum regulation.

## This value is adequate to maintain optimum regulation in the region to the right of line L=10H on curve OPERATION CHARACTERISTICS With Choke Input to Filter, provided the load current is not less than 35 ma. For load currents less than 35 ma, a larger value of inductance is required for optimum regulation.

## INSTALLATION AND APPLICATION

Type 6AX5-GT requires an octal socket and may be mounted in any position. Outline 22, OUTLINES SECTION. This type may be supplied with pin No.1 omitted. It is especially important that this tube, like other power-handling tubes, be adequately ventilated.

The *Rating Chart* presents graphically the relationships between maximum ac voltage input and maximum dc output current derived from the fundamental ratings for conditions of capacitor-input and choke-input filters. This graphical presentation provides for considerable latitude in choice of operating conditions.

The *Operation Characteristics* for a full-wave rectifier with capacitor-input filter show by means of boundary line "ADK" the limiting current and voltage relationships presented in the *Rating Chart*.

The *Operation Characteristics* for a full-wave rectifier with choke-input filter not only show by means of boundary line "CEK" the limiting current and voltage relationships presented in the *Rating Chart*, but also give information as to the

effect on regulation of various sizes of chokes. The solid-line curves show the dc voltage outputs which would be obtained if the filter chokes had infinite inductance. The long-dash lines radiating from the zero position are boundary lines for various sizes of chokes as indicated. The intersection of one of these lines with a solid-line curve indicates the point on the curve at which the choke no longer behaves as though it had infinite inductance. To the left of the choke boundary line, the regulation curves depart from the solid-line curves as shown by the representative short-dash regulation curves.

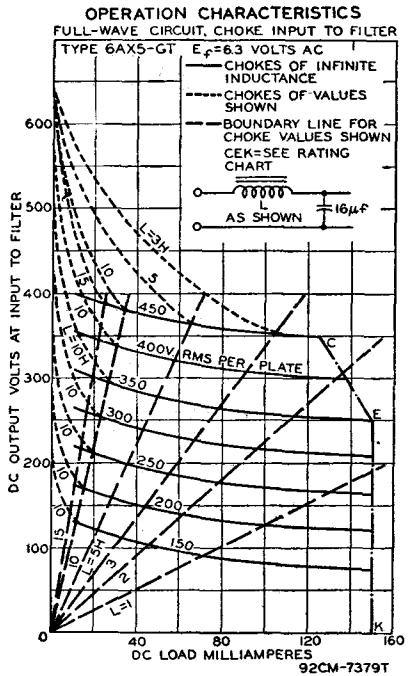
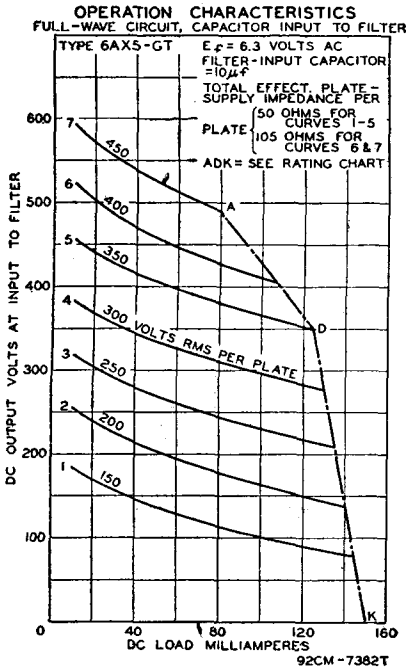
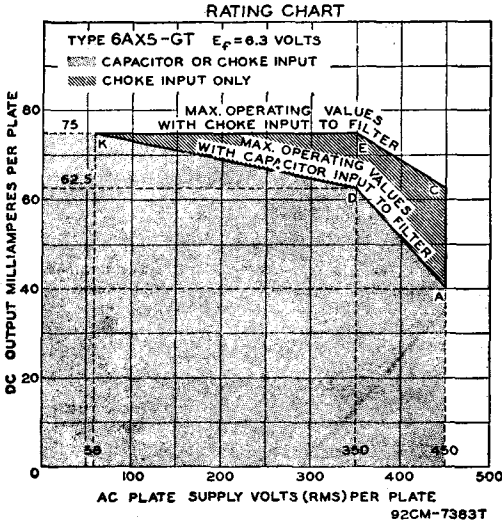

**MEDIUM-MU TRIODE—  
SEMIREMOTE-CUTOFF PENTODE**

**6AZ8**

Miniature type used in a wide variety of applications in television receivers. The pentode unit is used as an if amplifier, video amplifier, agc amplifier, or reactance tube. The triode unit is used in low-frequency oscillator, sync-separator, sync-clipper, and phase-splitter circuits. Outline 12, OUTLINES SECTION. Tube requires miniature nine-contact socket and may be mounted in any position.

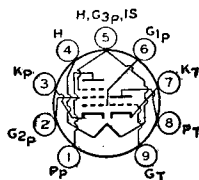

HEATER VOLTAGE (AC/DC).....	6.3	volts
HEATER CURRENT.....	0.45	ampere
DIRECT INTERELECTRODE CAPACITANCES:		
Triode Unit:		
Grid to Plate.....	1.7	$\mu\text{f}$
Grid to Cathode, Heater, and Internal Shield.....	2	$\mu\text{f}$
Plate to Cathode, Heater, and Internal Shield.....	1.7	$\mu\text{f}$
Pentode Unit:		
Grid No.1 to Plate.....	0.02 max	$\mu\text{f}$
Grid No.1 to Cathode, Heater, Grid No.2, Grid No.3, and Internal Shield.....	6.5	$\mu\text{f}$
Plate to Cathode, Heater, Grid No.2, Grid No.3, and Internal Shield.....	2.2	$\mu\text{f}$
Triode Grid to Pentode Plate.....	0.027 max	$\mu\text{f}$
Pentode Grid No.1 to Triode Plate.....	0.020 max	$\mu\text{f}$
Pentode Plate to Triode Plate.....	0.045 max	$\mu\text{f}$

**CLASS A<sub>1</sub> AMPLIFIER**

**Maximum Ratings:**

	Triode Unit	Pentode Unit	
PLATE VOLTAGE.....	300 max	300 max	volts
GRID-NO.2 (SCREEN-GRID) SUPPLY VOLTAGE.....	-	300 max	volts
GRID-NO.2 VOLTAGE.....	-	See curve page 67	
GRID-NO.1 (CONTROL-GRID) VOLTAGE:			
Positive bias value.....	0 max	0 max	volts
PLATE DISSIPATION.....	2.6 max	2 max	watts
GRID-NO.2 INPUT:			
For grid-No.2 voltages up to 150 volts.....	-	0.5 max	watts
For grid-No.2 voltages between 150 and 300 volts.....	-	See curve page 67	
PEAK HEATER-CATHODE VOLTAGE:			
Heater negative with respect to cathode.....	200 max	200 max	volts
Heater positive with respect to cathode.....	200 max	200 max	volts

**AVERAGE PLATE CHARACTERISTICS  
TRIODE UNIT**

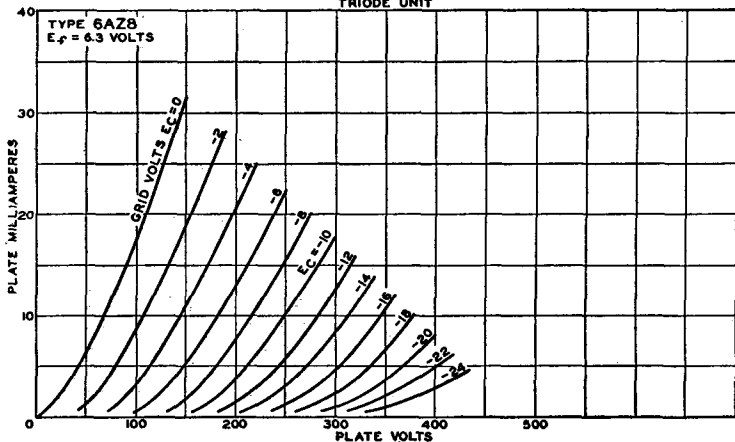

92CM-8520T



## Characteristics:

Plate Supply Voltage	200	200	volts
Grid-No.2 Voltage	-	150	volts
Grid-No.1 Voltage	-6	-	volts
Cathode-Bias Resistor	-	180	ohms
Amplification Factor	19	-	
Plate Resistance (Approx.)	5750	60000	ohms
Transconductance	3300	6000	$\mu$ mhos
Grid-No.1 Voltage (Approx.) for plate current of 10 $\mu$ a	-19	-	volts
Grid-No.1 Voltage (Approx.) for transconductance of 100 $\mu$ mhos	-	-12.5	volts
Plate Current	13	9.5	ma
Grid-No.2 Current	-	3	ma

## Maximum Circuit Values:

### Grid-No.1-Circuit Resistance:\*

For fixed-bias operation	0.5 max	0.25 max	megohm
For cathode-bias operation	1.0 max	1.0 max	megohm

\* The dc component must not exceed 100 volts.

\* If either unit is operating at maximum rated conditions, grid-No.1-circuit resistance for both units should not exceed the stated values.

## AVERAGE PLATE CHARACTERISTICS PENTODE UNIT

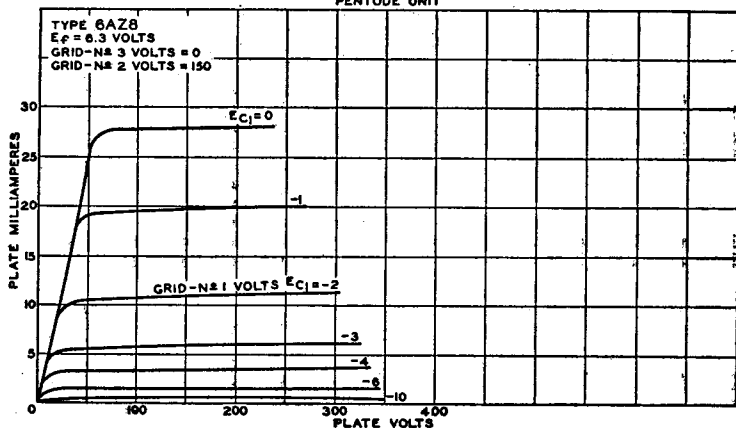

## POWER TRIODE

Glass octal type used in output stage of radio receivers and amplifiers. Outline 51, OUTLINES SECTION. Tube requires octal socket and may be mounted in any position. For installation and application information, and typical operation as a single-tube class A amplifier, refer to type 2A3. Filament volts (ac/dc), 6.3; amperes, 1.0. Maximum ratings as push-

# 6B4-G

pull class AB<sub>1</sub> amplifier: plate volts, 325; plate dissipation, 15 watts. Type 6B4-G is used principally for renewal purposes.

## PUSH-PULL CLASS AB<sub>1</sub> AMPLIFIER

Typical Operation (Values are for Two Tubes):

	Fixed Bias	Cathode Bias	
Plate Supply Voltage	325	325	volts
Grid Voltage*	-68	-	volts
Cathode-Bias Resistor	-	850	ohms
Plate Current	80	80	ma
Effective Load Resistance (Plate-to-plate)	3000	5000	ohms
Total Harmonic Distortion	2.5	5	per cent
Power Output	15	10	watts

\* Grid voltage referred to mid-point of ac-operated filament.

**DIRECT-COUPLED POWER TRIODE**

**6B5**

Glass type used as class A<sub>1</sub> power amplifier. One triode, the driver, is directly connected within the tube to the second, or output, triode. Outline 42, OUTLINES SECTION. Tube requires six-contact socket. Heater volts (ac/dc), 6.3; amperes, 0.8. Characteristics of input and output triodes as class A<sub>1</sub> amplifier follow. Input triode: plate volts, 300 *max*; grid volts, 0; plate

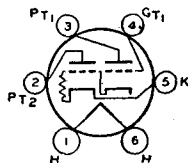

ma., 8. Output triode: plate volts, 300 *max*; plate ma., 45; plate resistance, 24000 ohms; load resistance, 7000 ohms; output watts, 4. This is a DISCONTINUED type listed for reference only.

**TWIN-DIODE—HIGH-MU TRIODE**

**6B6-G**

Glass octal type used as combined detector, amplifier, and avc tube. Outline 38, OUTLINES SECTION. Tube requires octal socket. Heater volts (ac/dc), 6.3; amperes, 0.3. Within its triode maximum plate-voltage rating of 250 volts, this type is similar electrically to type 6SQ7 and curves under that type apply to the 6B6-G. This is a DISCONTINUED type listed for reference only.

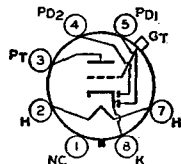

**TWIN-DIODE—REMOTE-CUTOFF PENTODE**

**6B7  
6B7S**

Glass types used as combined detector, amplifier, and avc tubes. Outline 39, OUTLINES SECTION. These types fit the small seven-contact (0.75-inch, pin-circle diameter) socket. Except for interelectrode capacitances, the electrical characteristics of the 6B7 are identical with those of type 6B8-G. Type 6B7S has the external shield connected to the cathode. In

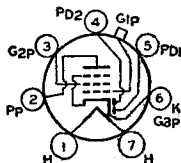

general, its electrical characteristics are similar to those of the 6B7, but the two types are usually not directly interchangeable. These are DISCONTINUED types listed for reference only.

**TWIN-DIODE—REMOTE-CUTOFF PENTODE**

**6B8  
6B8-G**

Metal type 6B8 and glass octal type 6B8-G are used as combined detector, amplifier, and avc tubes. Outlines 4 and 38, respectively, OUTLINES SECTION. Type 6B8 is used principally for renewal purposes; 6B8-G is a DISCONTINUED type listed for reference only. Tubes require octal socket. Type 6B8-G requires complete shielding of detector circuits.

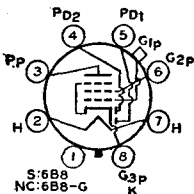

Heater volts (ac/dc), 6.3; amperes, 0.3. Maximum ratings of pentode unit as class A<sub>1</sub> amplifier: plate volts, 300 *max*; grid-No.2 (screen-grid) volts, 125 *max*; grid-No.2 supply volts, 300 *max*; grid-No.1 volts, 0 *min*; plate dissipation, 3.0 *max* watts (6B8), 2.25 *max* watts (6B8-G); grid-No.2 input, 0.3 *max* watt. For typical operation as a resistance-coupled amplifier, refer to Chart 5, RESISTANCE-COUPLED AMPLIFIER SECTION.

**REMOTE-CUTOFF PENTODE**

**6BA6**

Miniature type used as rf amplifier in standard broadcast and FM receivers, as well as in wide-band, high-frequency applications. This type is similar in performance to metal type

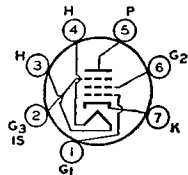

6SG7. The low value of grid-No.1-to-plate capacitance minimizes regenerative effects, while the high transconductance makes possible high signal-to-noise ratio.

HEATER VOLTAGE (AC/DC).....	6.3	volts
HEATER CURRENT.....	0.3	ampere
DIRECT INTERELECTRODE CAPACITANCES:		
Grid No.1 to Plate.....	0.0085 <i>max</i>	μμf
Grid No.1 to Cathode, Heater, Grid No.2, Grid No.3, and Internal Shield.....	5.5	μμf
Plate to Cathode, Heater, Grid No.2, Grid No.3, and Internal Shield....	5.0	μμf

# RCA Receiving Tube Manual

## Maximum Ratings:

## CLASS A<sub>1</sub> AMPLIFIER

PLATE VOLTAGE .....	300 max	volts
GRID-NO.2 (SCREEN-GRID) VOLTAGE .....	See curve page 67	
GRID-NO.2 SUPPLY VOLTAGE .....	300 max	volts
PLATE DISSIPATION .....	3 max	watts
GRID-NO.2 INPUT:		
For grid-No.2 voltages up to 150 volts .....	0.6 max	watt
For grid-No.2 voltages between 150 and 300 volts .....	See curve page 67	
GRID-NO.1 (CONTROL-GRID) VOLTAGE:		
Negative bias value .....	50 max	volts
Positive bias value .....	0 max	volts
PEAK HEATER-CATHODE VOLTAGE:		
Heater negative with respect to cathode .....	90 max	volts
Heater positive with respect to cathode .....	90 max	volts

## Characteristics:

Plate Supply Voltage .....	100	250	volts
Grid No.3 (Suppressor Grid) .....	Connected to cathode at socket		
Grid-No.2 Supply Voltage .....	100	100	volts
Cathode-Bias Resistor .....	68	68	ohms
Plate Resistance (Approx.) .....	0.25	1.0	megohm
Transconductance .....	4300	4400	μmhos
Grid-No.1 Voltage (Approx.) for transconductance of 40 μmhos .....	-20	-20	volts
Plate Current .....	10.8	11	ma
Grid-No.2 Current .....	4.4	4.2	ma

## INSTALLATION AND APPLICATION

Type 6BA6 requires miniature seven-contact socket and may be mounted in any position. Outline 11, OUTLINES SECTION. For heater and cathode considerations, refer to type 6AV6.

Control-grid bias variation will be found effective in changing the volume of the receiver. In order to obtain adequate volume control, an available grid-No.1-bias voltage of approximately 50 volts will be required. The exact value will depend upon the circuit design and operating conditions. This voltage may be obtained, depending on the receiver requirements, from a potentiometer across a fixed supply voltage, from a variable cathode-bias resistor, from the AVC system, or from a combination of these methods.

The grid-No. 2 (screen-grid) voltage may be obtained from a potentiometer or bleeder circuit across the B-supply source, or through a dropping resistor from the plate supply. The use of series resistors for obtaining satisfactory control of grid-No.2 voltage in the case of four-electrode tubes is usually impossible because of secondary-emission phenomena. In the 6BA6, however, because grid No.3 practically removes these effects, it is practical to obtain grid-No.2 voltage through a series-dropping resistor from the plate supply or from some high intermediate

AVERAGE PLATE CHARACTERISTICS

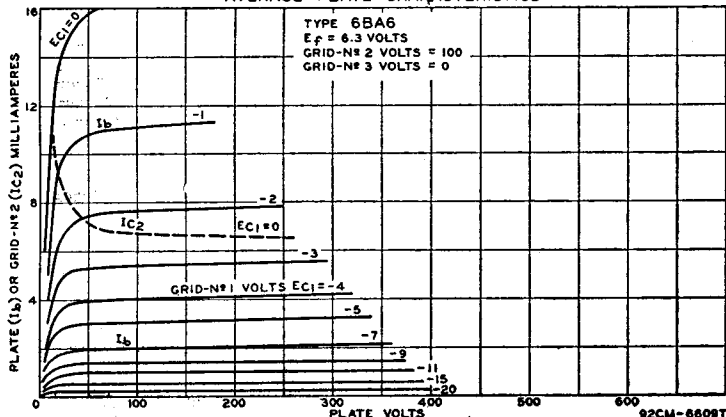

voltage, provided the source does not exceed the plate-supply voltage. With this method, the grid-No.2-to-cathode voltage will fall off very little from minimum to maximum value of the resistor controlling cathode bias. In some cases, it may actually rise. This rise of grid-No.2-to-cathode voltage above the normal maximum value is allowable because both the grid-No.2 current and the plate current are reduced simultaneously by a sufficient amount to prevent damage to the tube. It should be recognized that, in general, the series-resistor method of obtaining grid-No.2 voltage from a higher voltage supply necessitates the use of the variable cathode-resistor method of controlling volume in order to prevent too high a voltage on grid No.2. When grid-No.2 and control-grid voltage are obtained in this manner, the remote "cutoff" advantage of the 6BA6 can be fully realized. However, it should be noted that the use of a resistor in the grid-No.2 circuit will have an effect on the change in plate resistance with variation in grid-No.3 (suppressor-grid) voltage in case grid No.3 is utilized for control purposes.

**Grid No. 3 (suppressor-grid)** may be connected directly to the cathode or it may be made negative with respect to the cathode. For the latter condition, the grid-No.3 voltage may be obtained from a potentiometer or bleeder circuit, or from the avc system.

**PENTAGRID CONVERTER**

**6BA7**

Miniature type used as converter in superheterodyne circuits especially those for the FM broadcast band. Outline 14, OUTLINES SECTION. Tube requires miniature nine-contact socket

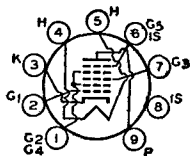

and may be mounted in any position. Its characteristics are similar to those of metal type 6SB7-Y. For heater and cathode considerations, refer to type 6AV6.

HEATER VOLTAGE (AC/DC) .....	6.3	volts
HEATER CURRENT .....	0.3	ampere

**DIRECT INTERELECTRODE CAPACITANCES:**

Grid No.3 to All Other Electrodes (RF Input) .....	9.5	μf
Plate to All Other Electrodes (Mixer Output) .....	8.3	μf
Grid No.1 to All Other Electrodes (Oscillator Input) .....	6.7	μf
Grid No.3 to Plate .....	0.19 max	μf
Grid No.1 to Grid No.3 .....	0.1 max	μf
Grid No.1 to Plate .....	0.06 max	μf
Grid No.1 to All Other Electrodes Except Cathode .....	3.4	μf
Grid No.1 to Cathode .....	3.3	μf
Cathode to All Other Electrodes Except Grid No.1 .....	4.0	μf

**Maximum Ratings:**

**CONVERTER SERVICE**

PLATE VOLTAGE .....	300 max	volts
GRID-NO.5-AND-INTERNAL-SHIELD VOLTAGE* .....	0 max	volts
GRIDS-NO.2-AND-NO.4 (SCREEN-GRID) VOLTAGE .....	100 max	volts
GRIDS-NO.2-AND-NO.4 SUPPLY VOLTAGE .....	300 max	volts
PLATE DISSIPATION .....	2.0 max	watts
GRIDS-NO.2-AND-NO.4 INPUT .....	1.5 max	watts
TOTAL CATHODE CURRENT .....	22 max	ma
<b>GRID-NO.3 VOLTAGE:</b>		
Negative bias value .....	100 max	volts
Positive bias value .....	0 max	volts
<b>PEAK HEATER-CATHODE VOLTAGE:</b>		
Heater negative with respect to cathode .....	90 max	volts
Heater positive with respect to cathode .....	90 max	volts

**Characteristics (Separate Excitation):\***

Plate Voltage .....	100	250	volts
Grid No.5 and Internal Shield* .....	Connected directly to ground		
Grids-No.2-and-No.4 (Screen-Grid) Voltage .....	100	100	volts
Grid-No.3 (Control-Grid) Voltage .....	-1.0	-1.0	volt
Grid-No.1 (Oscillator-Grid) Resistor .....	20000	20000	ohms
Plate Resistance (Approx.) .....	0.5	1.0	megohm

Conversion Transconductance .....	900	950	$\mu$ mhos
Conversion Transconductance (Approx.)** .....	3.5	3.5	$\mu$ mhos
Plate Current .....	3.6	3.8	ma
Grids-No 2-and-No.4 Current .....	10.2	10	ma
Grid-No.1 Current .....	0.35	0.35	ma
Total Cathode Current .....	14.2	14.2	ma

**NOTE:** The transconductance between grid No.1 and grids No.2 and No.4 connected to plate (not oscillating) is approximately 8000  $\mu$ mhos under the following conditions: signal applied to grid No.1 at zero bias; grids No.2 and No.4 and plate at 100 volts; grid No.3 grounded. Under the same conditions, the plate current is 32 milliamperes, and the amplification factor is 16.5.

\* The characteristics shown with separate excitation correspond very closely with those obtained in a self-excited oscillator circuit operating with zero bias.

\*\* With grid-No.3 bias of -20 volts.

^ Internal Shield (pins No.6 and No.8) connected directly to ground.

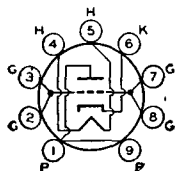

## MEDIUM-MU TRIODE

Miniature type used as an rf amplifier in the cathode-drive circuits of uhf television tuners covering the frequency range of 470 to 890 megacycles per second. Outline 10, OUTLINES

# 6BC4

**SECTION.** Tube requires miniature nine-contact socket and may be mounted in any position.

HEATER VOLTAGE (AC/DC) .....	6.3	volts
HEATER CURRENT .....	0.225	ampere
<b>DIRECT INTERELECTRODE CAPACITANCES (Approx.):</b>		
Grid to Plate .....	1.6	$\mu$ mf
Grid to Heater and Cathode .....	2.9	$\mu$ mf
Plate to Heater and Cathode .....	0.26	$\mu$ mf
Heater to Cathode .....	2.7	$\mu$ mf

## CLASS A<sub>1</sub> AMPLIFIER

**Maximum Ratings:**

PLATE VOLTAGE .....	250 max	volts
PLATE DISSIPATION .....	2.5 max	watts
CATHODE CURRENT .....	25 max	ma
<b>PEAK HEATER-CATHODE VOLTAGE:</b>		
Heater negative with respect to cathode .....	75 max	volts
Heater positive with respect to cathode .....	75 max	volts

AVERAGE PLATE CHARACTERISTICS

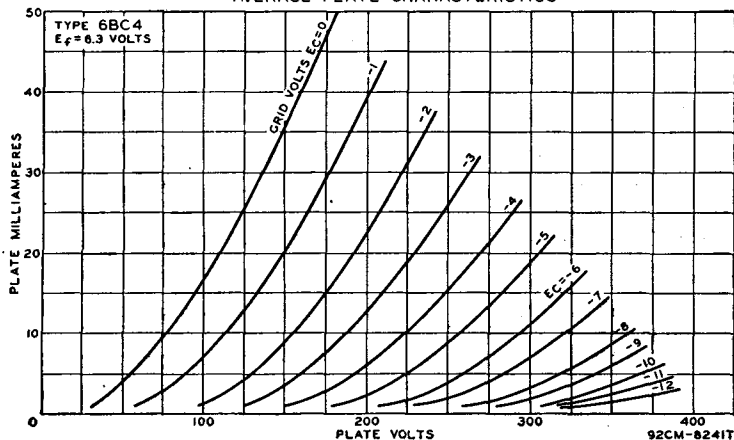

### Characteristics:

Plate Supply Voltage .....	150	volts
Cathode-Bias Resistor .....	100	ohms
Amplification Factor .....	48	
Plate Resistance .....	4800	ohms
Transconductance .....	10000	$\mu$ hos
Grid Voltage (Approx.) for plate current of 10 $\mu$ a. ....	-10	volts
Plate Current .....	14.5	ma

### Maximum Circuit Values (For maximum rated conditions):

Grid-Circuit Resistance:		Not recommended
For fixed-bias operation .....		
For cathode-bias operation .....		0.5 max megohm

## SHARP-CUTOFF PENTODE

# 6BC5

Miniature type used in compact radio equipment as an rf or if amplifier at frequencies up to 400 megacycles per second. Outline 11, OUTLINES SECTION. Tube requires miniature

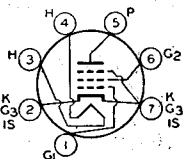

seven-contact socket and may be mounted in any position. Except for a slightly higher transconductance, this type is similar electrically to type 6AG5. Heater volts (ac/dc), 6.3; amperes, 0.3. For heater and cathode considerations, refer to type 6AV6.

## TRIPLE DIODE

# 6BC7

Miniature type containing three high-perveance diode units in one envelope used in dc restorer circuits of color television receivers. Also used in

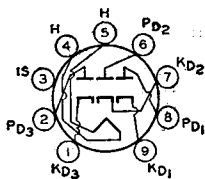

AM/FM radio receivers as a combination FM discriminator and AM detector tube. Outline 12, OUTLINES SECTION. Tube requires nine-contact miniature socket and may be mounted in any position.

HEATER VOLTAGE (AC/DC) .....	6.3	volts
HEATER CURRENT .....	0.450	ampere

### Maximum Ratings (Each Diode Unit):

PEAK INVERSE PLATE VOLTAGE .....	330 max	volts
PEAK PLATE CURRENT* .....	54 max	ma
DC OUTPUT CURRENT .....	12 max	ma
PEAK HEATER-CATHODE VOLTAGE:		
Heater negative with respect to cathode .....	200 max	volts
Heater positive with respect to cathode .....	200 max	volts

\* In rectifier service, the minimum total effective plate-supply impedance per plate is 560 ohms.

## MEDIUM-MU TWIN TRIODE

# 6BC8

Miniature type used in cascode-type circuits of vhf television tuners. This type has a semiremote-cutoff characteristic which reduces cross-modulation effects in the receiver. The

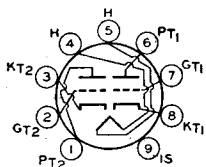

internal shield minimizes coupling between the two triode units so that either unit will give stable performance in vhf applications. Outline 12, OUTLINES SECTION. Tube requires miniature nine-contact socket and may be mounted in any position.

HEATER VOLTAGE (AC/DC) .....	6.3	volts
HEATER CURRENT .....	0.4	ampere

# RCA Receiving Tube Manual

## DIRECT INTERELECTRODE CAPACITANCES:\*

Grid to Plate (Each Unit) .....	1.4	$\mu\text{f}$
Grid to Cathode, Heater, and Internal Shield (Each Unit) .....	2.5	$\mu\text{f}$
Plate to Cathode, Heater, and Internal Shield (Each Unit) .....	1.3	$\mu\text{f}$
Heater to Cathode* (Each Unit) .....	2.3	$\mu\text{f}$
Grid of Unit No.1 to Grid of Unit No.2 .....	0.007 <i>max</i>	$\mu\text{f}$
Plate of Unit No.1 to Plate of Unit No.2 .....	0.015 <i>max</i>	$\mu\text{f}$

- \* With external shield tied to cathode of unit under test, except as noted.
- With external shield connected to ground.

## CLASS A<sub>1</sub> AMPLIFIER (Each Unit)

### Maximum Ratings:

PLATE VOLTAGE .....	250 <i>max</i>	watts
PLATE DISSIPATION .....	2 <i>max</i>	ma
CATHODE CURRENT .....	20 <i>max</i>	volts
PEAK HEATER-CATHODE VOLTAGE:		volts
Heater negative with respect to cathode .....	200 <i>max</i>	volts
Heater positive with respect to cathode .....	200 <sup>■</sup> <i>max</i>	volts

### Characteristics:

Plate Supply Voltage .....	150 <i>max</i>	ohms
Cathode-Bias Resistor .....	220	$\mu\text{mhos}$
Amplification Factor .....	35	volts
Transconductance .....	6200	ma
Grid Voltage (Approx.) for transconductance of 50 $\mu\text{mhos}$ .....	-13	
Plate Current .....	10	

### Maximum Circuit Value:

Grid-Circuit Resistance:		
For cathode-bias operation .....	0.5 <i>max</i>	megohm

- The dc component must not exceed 100 volts.

## AVERAGE CHARACTERISTICS FOR EACH UNIT

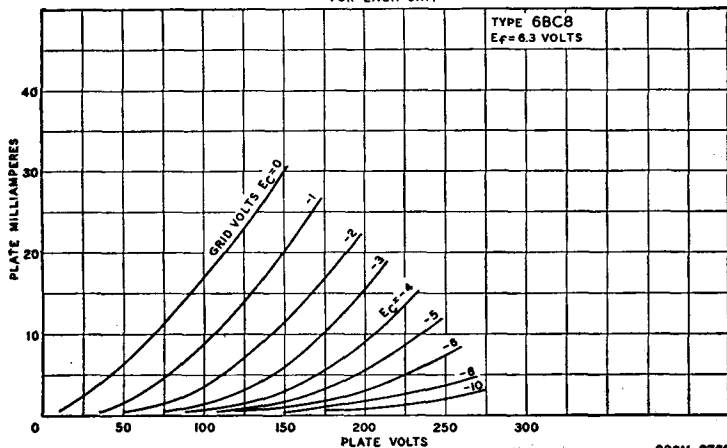

## SHARP-CUTOFF BEAM TRIODE

Glass octal types used for the voltage regulation of high-voltage, low-current dc power supplies in color television receivers. Outline 47, OUTLINES SECTION. Tubes require octal socket and may be mounted in any position. Heater volts (ac/dc), 6.3; amperes, 0.6. Maximum ratings for voltage-control service: dc plate volts, 6BD4 20000 *max*, 6BD4-A 27000 *max*; unregulated dc supply volts, 6BD4 40000

# 6BD4 6BD4-A

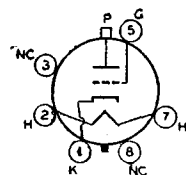

*max*, 6BD4-A 55000 *max*; dc grid volts, -125 *max*; peak grid volts, -550 *max*; dc plate ma., 1.5 *max*; plate dissipation, 6BD4 20 *max* watts, 6BD4-A 25 *max* watts; peak heater-cathode volts, 180 *max*. When operated at plate voltages above 16000 volts, these tubes will produce X-rays which can constitute a health hazard unless the tubes are adequately shielded. Type 6BD4 is a DISCONTINUED type listed for reference only. Type 6BD4-A is used principally for renewal purposes.

REMOTE-CUTOFF PENTODE

6BD6

Miniature type used as rf or if amplifier in radio receivers. This type is similar in performance to metal type 6SK7. Outline 11, OUTLINES SECTION. Tube requires miniature seven-contact socket and may be mounted in any position. Heater volts (ac/dc), 6.3; amperes, 0.3. For heater considerations, refer to type 6AV6. Maximum ratings as class A<sub>1</sub> amplifier: plate volts, 300 *max*; grid-No.2 volts,

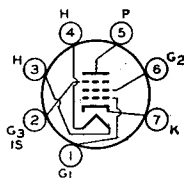

125 *max*; plate dissipation, 3 *max* watts; grid-No.2 input, 0.65 *max* watt; total cathode *ma.*, 14 *max*; peak heater-cathode volts, 90 *max*. Type 6BD6 is used principally for renewal purposes.

Characteristics:

Plate Voltage	100	125	250	volts
Grid-No.3 (Suppressor Grid)		Connected to cathode at socket		
Grid-No.2 (Screen-Grid) Voltage	100	125	100	volts
Grid-No.1 (Control-Grid) Voltage	-1	-3	-3	volts
Plate Resistance (Approx.)	0.15	0.18	0.8	megohm
Transconductance	2550	2350	2000	$\mu$ mhos
Grid-No.1 Voltage (Approx.) for transconductance of 10 $\mu$ mhos	-35	-45	-35	volts
Plate Current	13	13	9	ma
Grid-No.2 Current	5	5	3	ma

PENTAGRID CONVERTER

6BE6

Miniature type used as converter in superheterodyne circuits in both the standard broadcast and FM bands. The 6BE6 is similar in performance to metal type 6SA7. For general discussion of pentagrid types, see *Frequency Conversion* in ELECTRON TUBE APPLICATION SECTION.

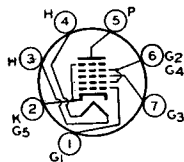

HEATER VOLTAGE (AC/DC)	6.3	volts
HEATER CURRENT	0.3	ampere

DIRECT INTERELECTRODE CAPACITANCES:

	Without External Shield	With External Shield	
Grid No.3 to Plate	0.30 <i>max</i>	0.25 <i>max</i>	$\mu$ f
Grid No.3 to Grid No.1	0.15 <i>max</i>	0.15 <i>max</i>	$\mu$ f
Grid No.1 to Plate	0.10 <i>max</i>	0.05 <i>max</i>	$\mu$ f
Grid No.3 to All Other Electrodes	7.0	7.0	$\mu$ f
Grid No.1 to All Other Electrodes	5.5	5.5	$\mu$ f
Plate to All Other Electrodes	8.0	13.0	$\mu$ f
Grid No.1 to Cathode and Grid No.5	3.0	3.0	$\mu$ f
Cathode and Grid No.5 to All Other Electrodes except Grid No.1	15.0	20.0	$\mu$ f

CONVERTER SERVICE

Maximum Ratings:

PLATE VOLTAGE	300 <i>max</i>	volts
GRIDS-NO.2-AND-NO.4 (SCREEN-GRID) VOLTAGE	100 <i>max</i>	volts
GRIDS-NO.2-AND-NO.4 SUPPLY VOLTAGE	300 <i>max</i>	volts
PLATE DISSIPATION	1.0 <i>max</i>	watt
GRIDS-NO 2-AND-NO.4 INPUT	1.0 <i>max</i>	watt
TOTAL CATHODE CURRENT	14 <i>max</i>	ma
GRID-NO.3 VOLTAGE:		
Negative bias value	50 <i>max</i>	volts
Positive bias value	0 <i>max</i>	volts
PEAK HEATER-CATHODE VOLTAGE:		
Heater negative with respect to cathode	90 <i>max</i>	volts
Heater positive with respect to cathode	90 <i>max</i>	volts



## Typical Operation (Separate Excitation)\*

Plate Voltage.....	100	250	volts
Grids-No.2-and-No.4 (Screen-Grid) Voltage.....	100	100	volts
Grid-No.1 (Oscillator-Grid) Voltage (rms).....	10	10	volts
Grid-No.3 (Control-Grid) Voltage.....	-1.5	-1.5	volts
Grid-No.1 (Oscillator-Grid) Resistor.....	20000	20000	ohms
Plate Resistance (Approx.).....	0.4	1.0	megohm
Conversion Transconductance.....	455	475	$\mu$ mhos
Grid-No. 3 Voltage for conversion transconductance of 10 $\mu$ mhos.....	-30	-30	volts
Plate Current.....	2.6	2.9	ma
Grids-No.2-and-No.4 Current.....	7.0	6.8	ma
Grid-No.1 Current.....	0.5	0.5	ma
Total Cathode Current.....	10.1	10.2	ma

Note: The transconductance between grid No.1 and grids No.2 and No.4 connected to plate (not oscillating) is approximately 7250  $\mu$ mhos under the following conditions: grids No.1 and No.3 at 0 volts; grids No.2 and No.4 and plate at 100 volts. Under the same conditions, the plate current is 25 ma., and the amplification factor is 20.

\* The characteristics shown with separate excitation correspond very closely with those obtained in a self-excited oscillator circuit operating with zero bias.

## INSTALLATION AND APPLICATION

Type 6BE6 requires miniature seven-contact socket and may be mounted in any position. Outline 11, OUTLINES SECTION. For heater and cathode considerations, refer to type 6AV6.

Because of the special structural arrangement of the 6BE6, a change in signal-grid voltage produces little change in cathode current. Consequently, an rf voltage on the signal grid produces little modulation of the electron current flowing in the cathode circuit. This feature is important because it is desirable that the impedance in the cathode circuit should produce little degeneration or regeneration of the signal-frequency input and intermediate-frequency output. Another important feature is that, because signal-grid voltage has very little effect on the space charge near the cathode, changes in avc bias produce little change in oscillator transconductance and in the input capacitance of grid No.1. There is, therefore, little detuning of the oscillator by avc bias.

A typical self-excited oscillator circuit employing the 6BE6 is given in the CIRCUIT SECTION.

In the 6BE6 operation characteristics curves with self-excitation,  $E_k$  is the voltage across the oscillator-coil section between cathode and ground;  $E_g$  is the oscillator voltage between cathode and grid.

OPERATION CHARACTERISTICS  
WITH SELF-EXCITATION

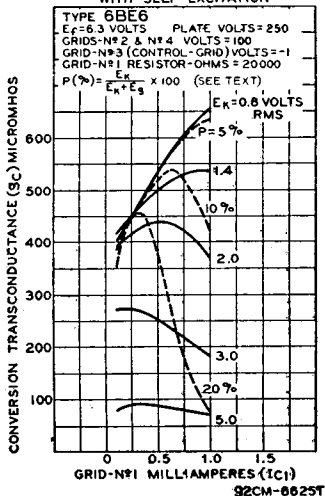

OPERATION CHARACTERISTICS  
WITH SEPARATE OSCILLATOR EXCITATION

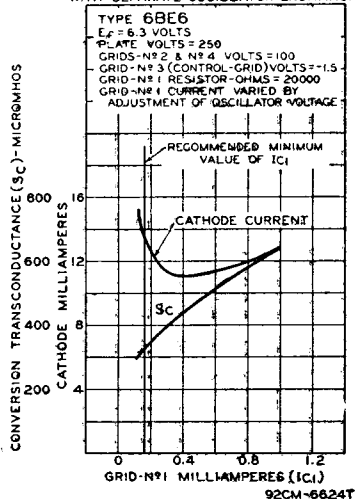

BEAM POWER TUBE

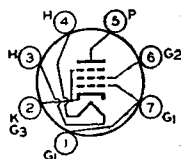

6BF5

Miniature type used in audio output stage of television and radio receivers. Triode-connected, it is used as a vertical deflection amplifier in television receivers. Outline 13, OUTLINES SECTION. Tube requires miniature seven-contact socket and may be mounted in any position. Heater volts (ac/dc), 6.3; amperes, 1.2. Maximum ratings as class A<sub>1</sub> amplifier: plate volts, 250 *max*; grid-No.2 volts, 117

*max*; plate dissipation, 5.5 *max* watts; grid-No.2 input, 1.25 *max* watts; peak heater-cathode volts; 200 *max* (dc component 100 *max* when heater is positive with respect to cathode). This type is used principally for renewal purposes.

Typical Operation:

Plate Voltage	110	volts
Grid-No.2 (Screen-Grid) Voltage	110	volts
Grid-No.1 (Control-Grid) Voltage	-7.5	volts
Peak AF Grid-No.1 Voltage	7.5	volts
Zero-Signal Plate Current	36	ma
Maximum-Signal Plate Current	39	ma
Zero-Signal Grid-No.2 Current	4	ma
Maximum-Signal Grid-No.2 Current	10.5	ma
Plate Resistance (Approx.)	12000	ohms
Transconductance	7500	μmhos
Plate Load Resistance	2500	ohms
Total Harmonic Distortion	10	per cent
Maximum-Signal Power Output	1.9	watts

TWIN DIODE—  
MEDIUM-MU TRIODE

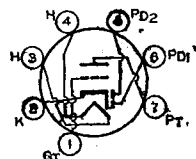

6BF6

Miniature type used in compact radio equipment as combined detector, amplifier, and avc tube. The triode unit is particularly useful as a driver for impedance- or transformer-coupled

output stages in automobile receivers. It is equivalent in performance to metal type 6SR7. Outline 11, OUTLINES SECTION. Tube requires miniature seven-contact socket and may be mounted in any position. For typical operation as a resistance-coupled amplifier, refer to Chart 9, RESISTANCE-COUPLED AMPLIFIER SECTION. For heater and cathode considerations, refer to type 6AV6.

HEATER VOLTAGE (AC/DC)	6.3	volts	
HEATER CURRENT	0.3	ampere	
DIRECT INTERELECTRODE CAPACITANCES:			
	<i>Without External Shield</i>	<i>With External Shield</i>	
Triode Grid to Triode Plate	2.0	2.0	μμf
Triode Grid to Cathode	1.8	1.8	μμf
Triode Plate to Cathode	1.1	0.8	μμf
Plate of Diode Unit No.1 to Cathode	1.4	0.7	μμf
Plate of Diode Unit No.2 to Cathode	1.5	1.0	μμf
Plate of Diode Unit No.1 to Triode Grid	0.06 <i>max</i>	0.07 <i>max</i>	μμf
Plate of Diode Unit No.2 to Triode Grid	0.05 <i>max</i>	0.06 <i>max</i>	μμf

Maximum Ratings: TRIODE UNIT AS CLASS A<sub>1</sub> AMPLIFIER

PLATE VOLTAGE	300 <i>max</i>	volts
PLATE DISSIPATION	2.5 <i>max</i>	watts
PEAK HEATER-CATHODE VOLTAGE:		
Heater negative with respect to cathode	90 <i>max</i>	volts
Heater positive with respect to cathode	90 <i>max</i>	volts

Typical Operation (With Transformer Coupling):

Plate Voltage	250	volts
Grid Voltage	-9	volts
Amplification Factor	16	
Plate Resistance	8500	ohms
Transconductance	1900	μmhos
Plate Current	9.5	ma
Load Resistance	10000	ohms
Total Harmonic Distortion	6.5	per cent
Power Output	300	mw

## Maximum Rating:

## DIODE UNITS

PLATE CURRENT (Each Unit)..... 1.0 max ma

The two diode plates and the triode unit have a common cathode. Diode biasing of the triode unit of the 6BF6 is not suitable. For diode operation curves, refer to type 6AV6.

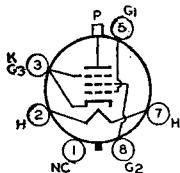
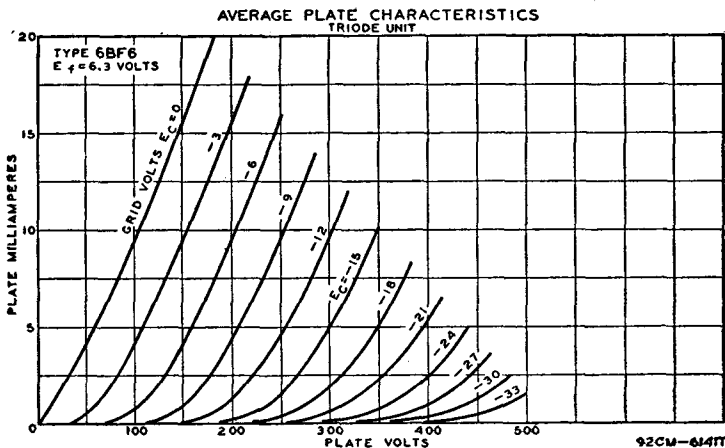

## BEAM POWER TUBE

Glass octal type used as output amplifier in horizontal-deflection circuits of television equipment and other applications where high pulse voltages occur during short duty cycles. Out-

# 6BG6-G

line 53, OUTLINES SECTION. Tube requires octal socket. Vertical tube mounting is preferred but horizontal operation is permissible if pins No.2 and 7 are in vertical plane.

HEATER VOLTAGE (AC/DC).....	6.3	volts
HEATER CURRENT.....	0.9	ampere
DIRECT INTERELECTRODE CAPACITANCES:		
Grid No.1 to Plate.....	0.34 max	μf
Grid No.1 to Cathode, Heater, Grid No.2, and Grid No.3.....	12	μf
Plate to Cathode, Heater, Grid No.2, and Grid No.3.....	6.5	μf
TRANSCONDUCTANCE <sup>o</sup> .....	6000	μmhos
MU-FACTOR, Grid No.2 to Grid No.1 <sup>o</sup> .....	8.0	

<sup>o</sup> For plate and grid-No.2 volts, 250; grid-No.1 volts, -15.

## HORIZONTAL DEFLECTION AMPLIFIER

### Maximum Ratings:

*For operation in a 525-line, 30-frame system*

DC PLATE VOLTAGE.....	700 max	volts
PEAK POSITIVE PULSE PLATE VOLTAGE*.....	6600 max	volts
PEAK NEGATIVE PULSE PLATE VOLTAGE.....	-1500 max	volts
DC GRID-NO.2 (SCREEN-GRID) VOLTAGE†.....	350 max	volts
PEAK NEGATIVE PULSE GRID-NO.1 VOLTAGE.....	-300 max	volts
CATHODE CURRENT:		
Peak.....	400 max	ma
Average.....	110 max	ma
PLATE DISSIPATION††.....	20 max	watts
GRID-NO.2 INPUT.....	3.2 max	watts
PEAK HEATER-CATHODE VOLTAGE:		
Heater negative with respect to cathode.....	200 max	volts
Heater positive with respect to cathode.....	200 max	volts
BULB TEMPERATURE (At hottest point).....	210 max	°C

**Maximum Circuit Value:**

Grid-No.1-Circuit Resistance..... 0.47 *maz* megohm

\* The duration of the voltage pulse must not exceed 15 per cent of one horizontal scanning cycle. In a 525-line, 30-frame system, 15 per cent of one horizontal scanning cycle is 10 microseconds.

† Preferably obtained through a series dropping resistor of sufficient magnitude to limit the grid-No.2 input to the rated maximum value.

‡ An adequate bias resistor or other means is required to protect the tube in the absence of excitation.

■ The dc component must not exceed 100 volts.

**AVERAGE PLATE CHARACTERISTICS  
WITH  $E_{C2}$  AS VARIABLE**

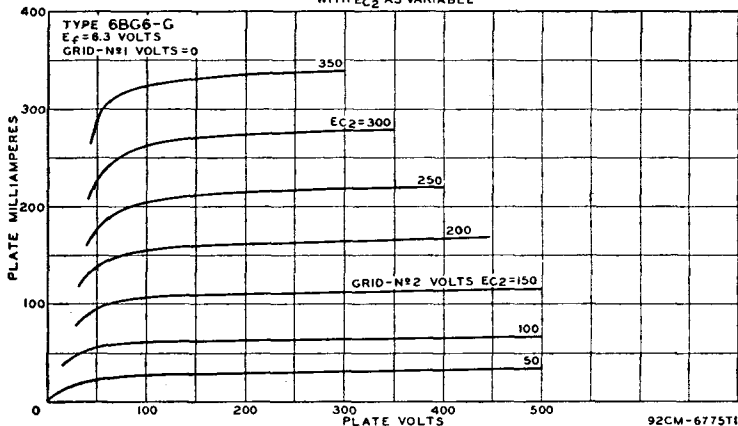

**AVERAGE PLATE CHARACTERISTICS  
WITH  $E_{C1}$  AS VARIABLE**

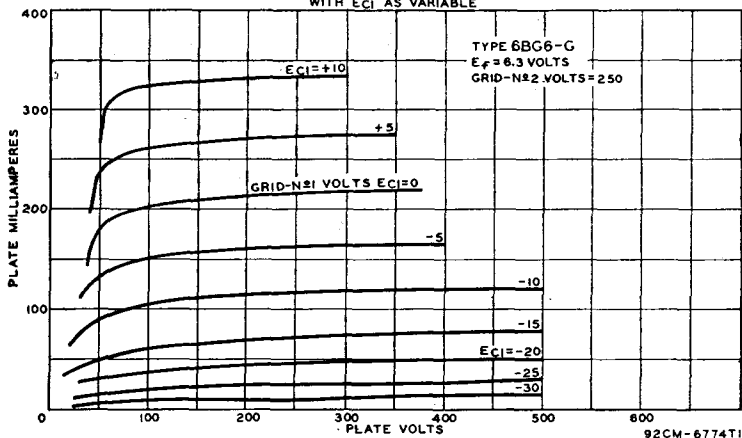

**SHARP-CUTOFF PENTODE**

Miniature type used as rf amplifier particularly in ac/dc receivers and in mobile equipment where low heater-current drain is important. It is particularly useful in high-frequency, wide-band applications. Outline 11, OUTLINES SECTION. Tube requires miniature seven-contact socket and may be mounted in any position. For heater and cathode considerations, refer to type 6AV6.

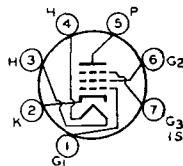

**6BH6**

requires miniature seven-contact socket and may be mounted in any position. For heater and cathode considerations, refer to type 6AV6.

# RCA Receiving Tube Manual

HEATER VOLTAGE (AC/DC).....	6.3	volts
HEATER CURRENT.....	0.15	ampere

### Maximum Ratings:

### CLASS A<sub>1</sub> AMPLIFIER

PLATE VOLTAGE.....	300 max	volts
GRID-NO.2 (SCREEN-GRID) VOLTAGE.....	See curve page 67	
GRID-NO.2 SUPPLY VOLTAGE.....	300 max	volts
PLATE DISSIPATION.....	3 max	watts
GRID-NO.2 INPUT:		
For grid-No.2 voltages up to 150 volts.....	0.5 max	watt
For grid-No.2 voltages between 150 and 300 volts.....	See curve page 67	
GRID-NO.1 (CONTROL-GRID) VOLTAGE:		
Negative bias value.....	50 max	volts
Positive bias value.....	0 max	volts
PEAK HEATER-CATHODE VOLTAGE:		
Heater negative with respect to cathode.....	90 max	volts
Heater positive with respect to cathode.....	90 max	volts

### Typical Operation and Characteristics:

Plate Voltage.....	100	250	volts
Grid-No.3 (Suppressor Grid).....	Connected to cathode at socket		
Grid-No.2 Voltage.....	100	150	volts
Grid-No.1 Voltage.....	-1	-1	volt
Plate Resistance (Approx.).....	0.7	1.4	megohms
Transconductance.....	3400	4600	μmhos
Grid-No.1 Voltage for plate current of 10 μa.....	-5	-7.7	volts
Plate Current.....	3.6	7.4	ma
Grid-No.2 Current.....	1.4	2.9	ma

AVERAGE PLATE CHARACTERISTICS

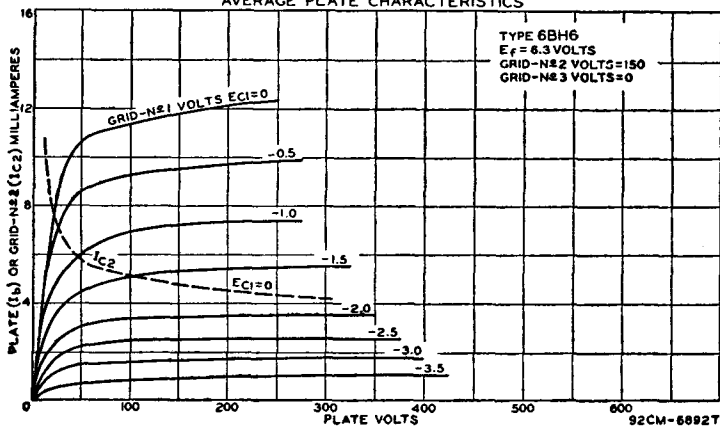

## MEDIUM-MU TRIODE— SHARP-CUTOFF PENTODE

# 6BH8

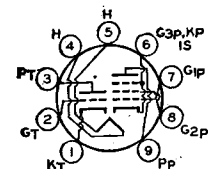

Miniature type used in a wide variety of applications in television receivers employing series-connected heater strings. The pentode unit is used as an if amplifier, a video amplifier, or an agc amplifier. The triode unit is used in low-frequency oscillator circuits. Outline 14, OUTLINES SECTION. Tube requires miniature nine-contact socket and may be mounted in any position.

HEATER VOLTAGE (AC/DC).....	6.3	volts
HEATER CURRENT.....	0.6	ampere
HEATER WARM-UP TIME (Average)*.....	11	seconds

**DIRECT INTERELECTRODE CAPACITANCES: (Approx.):**

<b>Triode Unit:</b>		
Grid to Plate .....	2.4	$\mu\text{f}$
Grid to Cathode and Heater .....	2.6	$\mu\text{f}$
Plate to Cathode and Heater .....	0.38	$\mu\text{f}$
<b>Pentode Unit:</b>		
Grid No.1 to Plate .....	0.046	$\mu\text{f}$
Grid No.1 to Cathode, Heater, Grid No.2, Grid No.3, and Internal Shield .....	7	$\mu\text{f}$
Plate to Cathode, Heater, Grid No.2, Grid No.3, and Internal Shield .....	2.4	$\mu\text{f}$
Triode Grid to Pentode Plate .....	0.016	$\mu\text{f}$
Pentode Grid No.1 to Triode Plate .....	0.004	$\mu\text{f}$
Pentode Plate to Triode Plate .....	0.095	$\mu\text{f}$

\* For definition of heater warm-up time and method for determining it, see type 6CG7.

## CLASS A<sub>1</sub> AMPLIFIER

**Maximum Ratings:**

	<i>Triode Unit</i>	<i>Pentode Unit</i>	
PLATE VOLTAGE .....	300 max	300 max	volts
GRID-NO.2 (SCREEN-GRID) SUPPLY VOLTAGE .....	-	300 max	volts
GRID-NO.2 VOLTAGE .....	-	See curve page 67	
<b>GRID-NO.1 (CONTROL-GRID) VOLTAGE:</b>			
Positive bias value .....	0 max	0 max	volts
PLATE DISSIPATION .....	2.5 max	3 max	watts
<b>GRID-NO.2 INPUT:</b>			
For grid-No.2 voltages up to 150 volts .....	-	1 max	watt
For grid-No.2 voltages between 150 and 300 volts .....	-	See curve page 67	
<b>PEAK HEATER-CATHODE VOLTAGE:</b>			
Heater negative with respect to cathode .....	200 max	200 max	volts
Heater positive with respect to cathode .....	200 <sup>max</sup>	200 <sup>max</sup>	volts

**Characteristics:**

Plate Supply Voltage .....	150	200	volts
Grid-No.2 Supply Voltage .....	-	125	volts
Grid-No.1 Voltage .....	-5	-	volts
Cathode-Bias Resistor .....	-	82	ohms
Amplification Factor .....	17	-	
Plate Resistance (Approx.) .....	5150	150000	ohms
Transconductance .....	3300	7000	$\mu\text{mhos}$
Grid-No.1 Voltage (Approx.) for plate current of 100 $\mu\text{a}$ .....	-14	-8	volts
Plate Current .....	9.5	15	ma
Grid-No.2 Current .....	-	3.4	ma

**Maximum Circuit Values:**

<b>Grid-No.1-Circuit Resistance:</b>			
For fixed-bias operation .....	0.5 max	0.25 max	megohm
For cathode-bias operation .....	1.0 max	1.0 max	megohm

■ The dc component must not exceed 100 volts.

### AVERAGE CHARACTERISTICS TRIODE UNIT

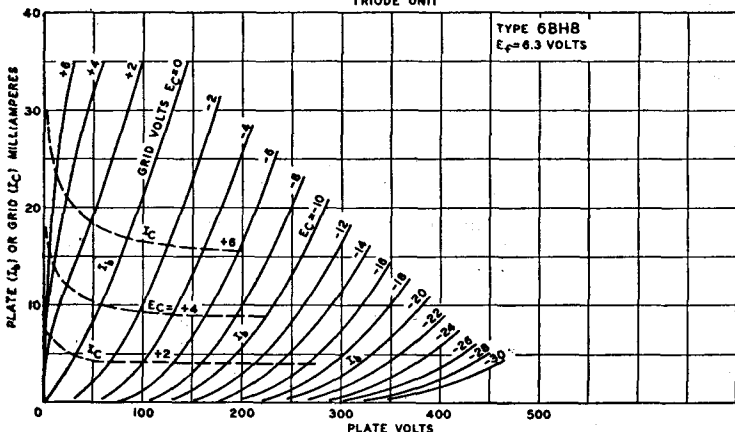

92CM-8790T

## AVERAGE CHARACTERISTICS PENTODE UNIT

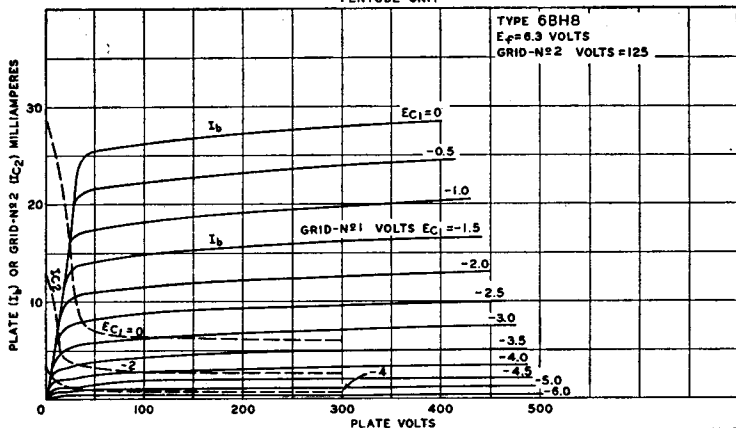

92CM-8797T

## REMOTE-CUTOFF PENTODE

Miniature type used as rf amplifier in high-frequency and wide-band applications. Features high transconductance and low grid-to-plate capacitance. Outline 11, OUTLINES SEC-

# 6BJ6

**TION.** Tube requires miniature seven-contact socket and may be mounted in any position. For heater and cathode considerations, refer to type 6AV6.

HEATER VOLTAGE (AC/DC) .....	6.3	volts
HEATER CURRENT .....	0.15	ampere
DIRECT INTERELECTRODE CAPACITANCES:		
Grid No.1 to Plate .....	0.0035 max	$\mu$ f
Grid No.1 to Cathode, Heater, Grid No. 2, Grid No. 3, and Internal Shield .....	4.5	$\mu$ f
Plate to Cathode, Heater, Grid No. 2, Grid No. 3, and Internal Shield .....	5.5	$\mu$ f

### Maximum Ratings:

### CLASS A<sub>1</sub> AMPLIFIER

PLATE VOLTAGE .....	300 max	volts
GRID-NO.2 (SCREEN-GRID) VOLTAGE .....	See curve page 67	
GRID-NO.2 SUPPLY VOLTAGE .....	300 max	volts
PLATE DISSIPATION .....	3 max	watts
GRID-NO.2 INPUT:		
For grid-No.2 voltages up to 150 volts .....	0.6 max	watt
For grid-No.2 voltages between 150 and 300 volts .....	See curve page 67	
GRID-NO.1 (CONTROL-GRID) VOLTAGE:		
Negative bias value .....	50 max	volts
Positive bias value .....	0 max	volts
PEAK HEATER-CATHODE VOLTAGE:		
Heater negative with respect to cathode .....	90 max	volts
Heater positive with respect to cathode .....	90 max	volts

### Characteristics:

Plate Voltage .....	100	250	volts
Grid No.3 (Suppressor Grid) .....	Connected to cathode at socket		
Grid-No.2 Voltage .....	100	100	volts
Grid-No.1 Voltage .....	-1.0	-1.0	volt
Plate Resistance (Approx.) .....	0.25	1.3	megohms
Transconductance .....	3650	3600	$\mu$ mhos
Grid-No.1 Voltage (Approx.) for transconductance of 15 $\mu$ mhos .....	-20	-20	volts
Plate Current .....	9.0	9.2	ma
Grid-No.2 Current .....	3.5	3.3	ma

## AVERAGE PLATE CHARACTERISTICS PENTODE CONNECTION

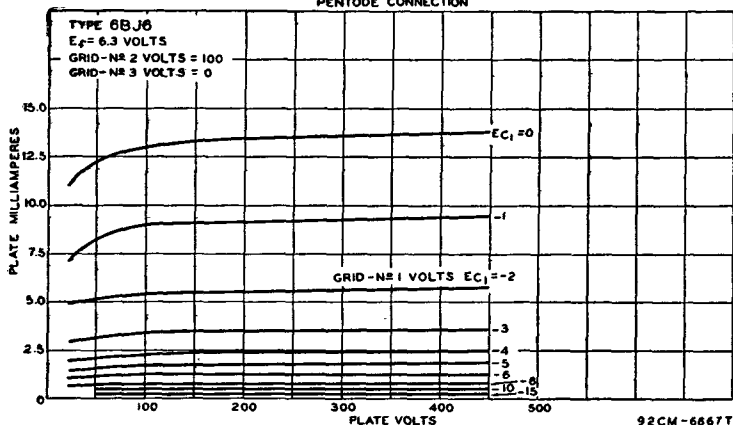

## SHARP-CUTOFF BEAM TRIODE

Glass octal type used for the voltage regulation of high-voltage, low-current dc power supplies in color television receivers. Outline 50, OUT-LINES SECTION. Tube requires octal socket and may be mounted in any position.

# 6BK4

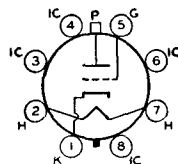

HEATER VOLTAGE (AC/DC) .....	6.3	volts
HEATER CURRENT .....	0.2	ampere
DIRECT INTERELECTRODE CAPACITANCES:		
Grid to Plate .....	0.03	$\mu$ f
Grid to Cathode and Heater .....	2.6	$\mu$ f
Plate to Cathode and Heater .....	1	$\mu$ f
AMPLIFICATION FACTOR .....	2000	

### Maximum Ratings:

### VOLTAGE-CONTROL SERVICE

DC PLATE VOLTAGE .....	25000 max	volts
UNREGULATED DC SUPPLY VOLTAGE .....	55000 max	volts

## AVERAGE TRANSFER CHARACTERISTICS

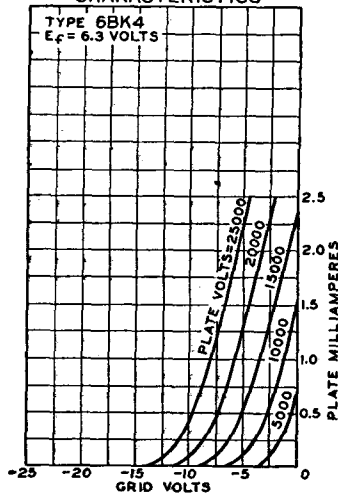



<b>GRID VOLTAGE:</b>		
DC Value.....	-125 <i>max</i>	volts
Peak Value.....	-400 <i>max</i>	volts
<b>DC PLATE CURRENT:</b>		
.....	1.5 <i>max</i>	ma
<b>PLATE DISSIPATION:</b>		
.....	25 <i>max</i>	watts
<b>PEAK HEATER-CATHODE VOLTAGE:</b>		
Heater negative with respect to cathode.....	225 <i>max</i>	volts
Heater positive with respect to cathode.....	Not recommended	
<b>Maximum Circuit Value:</b>		
<b>Grid-Circuit Resistance:</b>		
For use with "Flyback Transformer" high-voltage supply.....	3 <i>max</i>	megohms

## BEAM POWER TUBE

Miniature type used in audio output stages of television and radio receivers. Outline 14, OUTLINES SECTION. Tube requires miniature nine-contact socket and may be mounted in any position. Heater volts (ac/dc), 6.3; amperes, 1.2. This type is used principally for renewal purposes.

# 6BK5

### CLASS A<sub>1</sub> AMPLIFIER

<b>Maximum Ratings:</b>		
<b>PLATE VOLTAGE:</b> .....	250 <i>max</i>	volts
<b>GRID-NO.2 (SCREEN-GRID) VOLTAGE:</b> .....	250 <i>max</i>	volts
<b>DC GRID-NO.1 (CONTROL-GRID) VOLTAGE:</b>		
Positive bias value.....	0 <i>max</i>	volts
<b>GRID-NO.2 INPUT:</b> .....	2.5 <i>max</i>	watts
<b>PLATE DISSIPATION:</b> .....	9 <i>max</i>	watts
<b>PEAK HEATER-CATHODE VOLTAGE:</b>		
Heater negative with respect to cathode.....	100 <i>max</i>	volts
Heater positive with respect to cathode.....	100 <i>max</i>	volts

#### Typical Operation:

Plate Voltage.....	250	volts
Grid-No.2 Voltage.....	250	volts
Grid-No.1 Voltage.....	-5	volts
Peak AF Grid-No.1 Voltage.....	5	volts
Zero-Signal Plate Current.....	35	ma
Maximum-Signal Plate Current (Approx.).....	37	ma
Zero-Signal Grid-No.2 Current.....	3.5	ma
Maximum-Signal Grid-No.2 Current (Approx.).....	10	ma
Plate Resistance (Approx.).....	0.1	megohm
Transconductance.....	8500	$\mu$ mhos
Load Resistance.....	6500	ohms
Total Harmonic Distortion (Approx.).....	7	per cent
Power Output.....	3.5	watts

#### Maximum Circuit Values:

<b>Grid-No.1-Circuit Resistance:</b>		
For fixed-bias operation.....	0.1 <i>max</i>	megohm
For cathode-bias operation.....	0.5 <i>max</i>	megohm

## MEDIUM-MU TWIN TRIODE

Miniature type used as rf amplifier in tuners of vhf television receivers or as low-noise if preamplifier tube in uhf television receivers employing a crystal mixer. Especially useful in the rf stage of television receivers utilizing a cathode-drive amplifier of the direct-coupled type or in push-pull cathode-drive rf amplifiers. Outline 12, OUTLINES SECTION. Tube requires miniature nine-contact socket and may

# 6BK7-A

be mounted in any position. Heater volts (ac/dc), 6.3; amperes, 0.45. Maximum ratings and characteristics as class A<sub>1</sub> amplifier (each unit): plate volts, 150 (300 *max*); dc grid volts, -50 *max*; cathode-bias resistor, 56 ohms; plate resistance (approx.), 4600 ohms; transconductance, 9300 ohms; plate ma., 18; plate dissipation, 2.7 *max* watts; grid volts (approx.) for plate current of 10  $\mu$ a, -11; peak heater-cathode volts, 90 *max*. This type is used principally for renewal purposes.

# 6BL4

## HALF-WAVE VACUUM RECTIFIER

Glass octal type used as a damper tube in horizontal deflection circuits of color television receivers. Outline 40, OUTLINES SECTION. Tube requires octal socket and may be mounted in

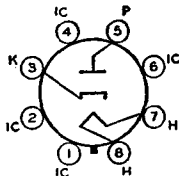

any position. It is especially important that this tube, like other power-handling tubes, be adequately ventilated. For curve of average plate characteristics, see page 64.

HEATER VOLTAGE (AC/DC).....	6.3	volts
HEATER CURRENT.....	3.0	amperes
DIRECT INTERELECTRODE CAPACITANCES (Approx.):		
Plate to Heater and Cathode.....	11.5	$\mu\mu\text{f}$
Cathode to Heater and Plate.....	16	$\mu\mu\text{f}$
Heater to Cathode.....	5	$\mu\mu\text{f}$

### DAMPER SERVICE

For operation in a 525-line, 30-frame system

<b>Maximum Ratings:</b>		
PEAK INVERSE PLATE VOLTAGE # (Absolute Maximum).....	4500° max	volts
PEAK PLATE CURRENT.....	1200 max	ma
DC PLATE CURRENT.....	200 max	ma
PLATE DISSIPATION.....	8.0 max	watts
PEAK HEATER-CATHODE VOLTAGE:		
Heater negative with respect to cathode # (Absolute Maximum).....	4500° max	volts
Heater positive with respect to cathode.....	300■ max	volts

# The duration of the voltage pulse must not exceed 15 per cent of one horizontal scanning cycle. In a 525-line, 30-frame system, 15 per cent of one horizontal scanning is 10 microseconds.

° Under no circumstances should this absolute value be exceeded.

\* The dc component must not exceed 900 volts.

■ The dc component must not exceed 100 volts.

## MEDIUM-MU TWIN TRIODE

Glass octal type used as a combined vertical deflection amplifier and vertical oscillator in television receivers. Outline 22, OUTLINES SECTION. Tube requires octal socket and may be mounted in any position.

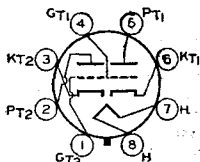

# 6BL7-GT

HEATER VOLTAGE (AC/DC).....	6.3	volts
HEATER CURRENT.....	1.5	amperes

### CLASS A<sub>1</sub> AMPLIFIER (Each Unit)

<b>Characteristics:</b>		
Plate Voltage.....	250	volts
Grid Voltage.....	-9	volts
Amplification Factor.....	15	
Plate Resistance.....	2150	ohms
Transconductance.....	7000	$\mu\text{mhos}$
Grid Voltage (Approx.) for plate current of 25 $\mu\text{a}$ .....	-25	volts
Plate Current.....	40	ma
Grid Voltage (Approx.) for plate voltage of 600 volts and plate current of 50 $\mu\text{a}$ .....	-60	volts

### VERTICAL DEFLECTION AMPLIFIER (Each Unit)

For operation in a 525-line, 30-frame system

<b>Maximum Ratings:</b>		
DC PLATE VOLTAGE.....	500 max	volts
PEAK POSITIVE-PULSE PLATE VOLTAGE†.....	2000 max	volts
PEAK NEGATIVE-PULSE GRID VOLTAGE.....	-500 max	volts
DC CATHODE CURRENT.....	60 max	ma
PLATE DISSIPATION.....	10 max	watts
(Total for both units).....	12 max	watts
PEAK HEATER-CATHODE VOLTAGE:		
Heater negative with respect to cathode.....	200 max	volts
Heater positive with respect to cathode.....	200 max	volts

### Maximum Circuit Value:

Grid-Circuit Resistance:	
For cathode-bias operation.....	4.7 max megohms

† The duration of the voltage pulse must not exceed 15 per cent of one vertical scanning cycle. In a 525-line, 30-frame system, 15 per cent of one vertical scanning cycle is 2.5 milliseconds.

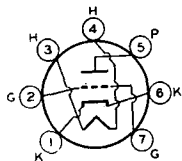

### MEDIUM-MU TRIODE

Miniature type used as rf amplifier in grid-drive circuits of vhf television tuners. The double base-pin connections for both cathode and grid reduce effective lead inductance and

# 6BN4

lead resistance with consequent reduction in input conductance. In addition, the basing arrangement facilitates isolation of input and output circuits and permits short, direct connections to base-pin terminals. Outline 11, OUTLINES SECTION. Tube requires miniature seven-contact socket and may be mounted in any position.

HEATER VOLTAGE (AC/DC) .....	6.3	volts
HEATER CURRENT .....	0.2	ampere
DIRECT INTERELECTRODE CAPACITANCES (Approx.):*		
Grid to Plate .....	1.2	$\mu\text{f}$
Grid to Cathode and Heater .....	3.2	$\mu\text{f}$
Plate to Cathode and Heater .....	1.4	$\mu\text{f}$
Heater to Cathode .....	2.8	$\mu\text{f}$

\* With external shield tied to cathode.

### CLASS A<sub>1</sub> AMPLIFIER

#### Maximum Ratings:

PLATE VOLTAGE .....	250 <i>max</i>	volts
GRID VOLTAGE:		
Positive bias value .....	0 <i>max</i>	volts
PLATE DISSIPATION .....	2 <i>max</i>	watts
CATHODE CURRENT .....	20 <i>max</i>	ma
PEAK HEATER-CATHODE VOLTAGE:		
Heater negative with respect to cathode .....	90 <i>max</i>	volts
Heater positive with respect to cathode .....	90 <i>max</i>	volts

#### Characteristics:

Plate-Supply Voltage .....	150	volts
Cathode-Bias Resistor .....	220	ohms
Amplification Factor .....	43	
Plate Resistance (Approx.) .....	6300	ohms
Transconductance .....	6800	$\mu\text{mhos}$
Grid Voltage (Approx.) for plate current of 100 $\mu\text{a}$ .....	-6	volts
Plate Current .....	9	ma

#### Maximum Circuit Value:

Grid-Circuit Resistance .....	0.5 <i>max</i>	megohm
-------------------------------	----------------	--------

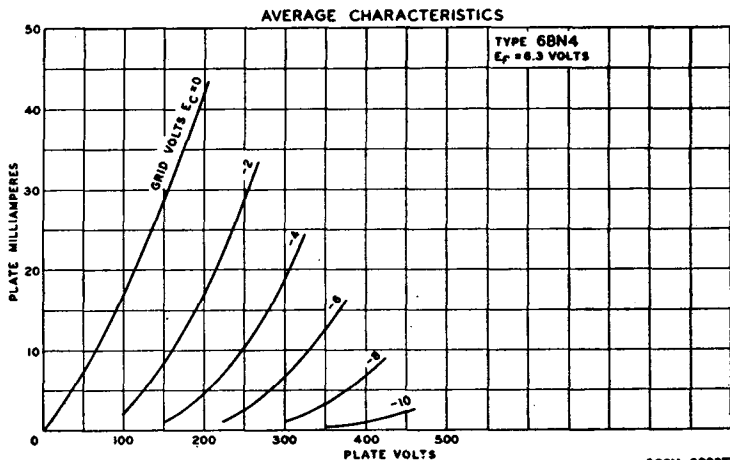

92CM-8839T

**BEAM PENTODE**

**6BN6**

Miniature type used as combined limiter, discriminator, and audio-voltage amplifier in intercarrier television and FM receivers, Outline 16, OUTLINES SECTION. Tube requires miniature seven-contact socket and may be mounted in any position.

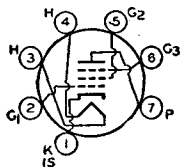

HEATER VOLTAGE (AC/DC) .....	6.3	volts
HEATER CURRENT .....	0.3	ampere

**LIMITER AND DISCRIMINATOR SERVICE**

**Maximum Ratings:**

PLATE-SUPPLY VOLTAGE .....	300 max	volts
GRID-NO.2 VOLTAGE .....	100 max	volts
GRID-NO.1 VOLTAGE:		
Positive peak value .....	55 max	volts
CATHODE CURRENT .....	11.5 max	ma
PEAK HEATER-CATHODE VOLTAGE:		
Heater negative with respect to cathode .....	90 max	volts
Heater positive with respect to cathode .....	90 max	volts

**6BQ6-GT**  
**6BQ6-GTB**  
**/6CU6**

**BEAM POWER TUBE**

Glass octal types used as horizontal deflection amplifiers in television receivers. Outline 30, OUTLINES SECTION. Tubes require octal socket and may be mounted in any position. These types may be supplied with pin No.1 omitted. Type 6BQ6-GT is used principally for renewal purposes.

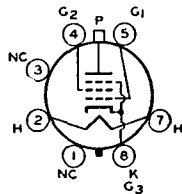

HEATER VOLTAGE (AC/DC) .....	6.3	volts
HEATER CURRENT .....	1.2	amperes
DIRECT INTERELECTRODE CAPACITANCES (Approx.):		
Grid No.1 to Plate .....	0.6	$\mu\mu\text{f}$
Grid No.1 to Cathode, Heater, Grid No.2, and Grid No.3 .....	15	$\mu\mu\text{f}$
Plate to Cathode, Heater, Grid No.2, and Grid No.3 .....	7.5	$\mu\mu\text{f}$
TRANSCONDUCTANCE* (6BQ6-GTB/6CU6)	6000	$\mu\text{mhos}$
MU-FACTOR, Grid No.2 to Grid No.1**	4.3	

\* For plate volts, 250; grid-No.2 volts, 150; grid-No.1 volts, -22.5; plate ma., 65; grid-No.2 ma., 2.1.

\*\* For plate and grid-No.2 volts, 150; grid-No.1 volts, -22.5.

**AVERAGE PLATE CHARACTERISTICS**

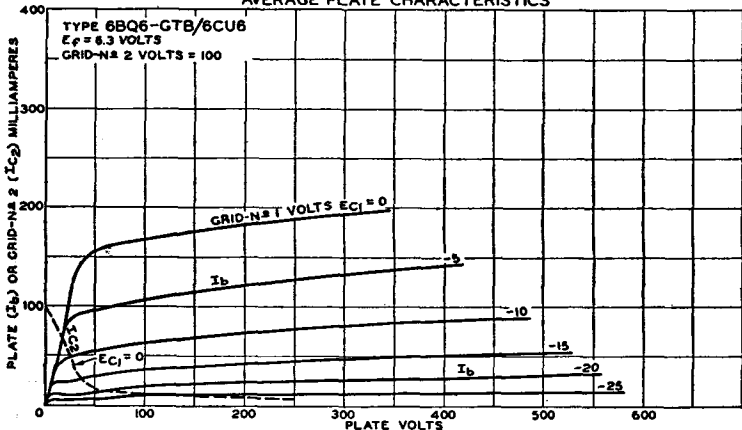

92CM-8500T

# RCA Receiving Tube Manual

## HORIZONTAL DEFLECTION AMPLIFIER For operation in a 525-line, 30-frame system

Maximum Ratings:	6BQ6-GT	6BQ6-GTB/6CU6	
DC PLATE VOLTAGE.....	550 max	600 max	volts
PEAK POSITIVE-PULSE PLATE VOLTAGE* (Absolute Maximum).....	5500†max	6000†max	volts
PEAK NEGATIVE-PULSE PLATE VOLTAGE.....	-1250 max	-1250 max	volts
DC GRID-NO.2 (SCREEN-GRID) VOLTAGE.....	175 max	200 max	volts
PEAK NEGATIVE-PULSE GRID-NO.1 (CONTROL-GRID)VOLTAGE.....	-300 max	-300 max	volts
CATHODE CURRENT:			
Peak.....	400 max	400 max	ma
Average.....	110 max	112.5 max	ma
GRID-NO.2 INPUT.....	2.5 max	2.5 max	watts
PLATE DISSIPATION‡.....	11 max	11 max	watts
PEAK HEATER-CATHODE VOLTAGE:			
Heater negative with respect to cathode.....	200 max	200 max	volts
Heater positive with respect to cathode.....	200‡max	200‡max	volts
BULB TEMPERATURE (At hottest point).....	220 max	220 max	°C

### Maximum Circuit Value:

Grid-No.1-Circuit Resistance.....	0.47 max megohm
-----------------------------------	-----------------

• The duration of the voltage pulse must not exceed 15 per cent of one horizontal scanning cycle. In a 525-line, 30-frame system, 15 per cent of one horizontal scanning cycle is 10 microseconds.

† Under no circumstances should this absolute value be exceeded.

‡ An adequate bias resistor or other means is required to protect the tube in the absence of excitation.

■ The dc component must not exceed 100 volts.

## MEDIUM-MU TWIN TRIODE

Miniature types used as rf amplifiers in tuners of vhf television receivers or as low-noise if pre-amplifier tubes in uhf television receivers employing a crystal mixer. Both types are especially

# 6BQ7 6BQ7-A

useful in the rf stage of television receivers utilizing a cathode-drive amplifier of the direct-coupled type or in push-pull cathode-drive rf amplifiers. Outline 12, OUTLINES SECTION. Tubes require miniature nine-contact socket and may be mounted in any position. Type 6BQ7 is a DISCONTINUED type listed for reference only.

HEATER VOLTAGE (AC/DC).....	6.3	volts	
HEATER CURRENT.....	0.4	ampere	
DIRECT INTERELECTRODE CAPACITANCES (Approx.):°	<i>Unit No.1</i>	<i>Unit No.2</i>	
Grid to Plate.....	1.2	1.2	μf
Grid to Cathode, Heater, and Internal Shield.....	2.6	-	μf
Cathode to Grid, Heater, and Internal Shield.....	-	5.0	μf
Plate to Cathode, Heater, and Internal Shield.....	1.2	-	μf
Plate to Grid, Heater, and Internal Shield.....	-	2.2	μf
Plate to Cathode.....	0.12 max	0.12 max	μf
Heater to Cathode (6BQ7).....	2.2	2.3	μf
Heater to Cathode (6BQ7-A).....	2.6	2.6	μf
Plate of Unit No.1 to Plate of Unit No.2.....	0.010 max		μf
Plate of Unit No.2 to Plate and Grid of Unit No.1.....	0.024 max		μf

### Maximum Ratings:

PLATE SUPPLY VOLTAGE.....	250*max	volts
PLATE DISSIPATION.....	2 max	watts
CATHODE CURRENT.....	20 max	ma
PEAK HEATER-CATHODE VOLTAGE:		
Heater negative with respect to cathode.....	200*max	volts
Heater positive with respect to cathode.....	200‡max	volts

### Characteristics:

	6BQ7	6BQ7-A	
Plate Supply Voltage.....	150	150	volts
Cathode-Bias Resistor.....	220	220	ohms
Amplification Factor.....	35	38	
Plate Resistance.....	5800	5900	ohms
Transconductance.....	6000	6400	μmhos
Plate Current.....	9	9	ma
Grid Voltage (Approx.) for plate current of 100 μa.....	-	-6.5	volts

° With external shield connected to internal shield.

\* In cathode-drive circuits with direct-coupled drive, it is permissible for this voltage to be as high as 300 volts.

‡ The dc component must not exceed 100 volts.

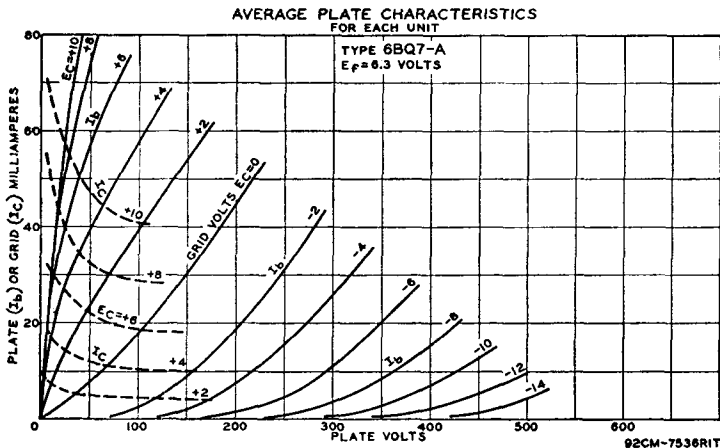

## MEDIUM-MU TWIN TRIODE

Glass octal type used as combined vertical deflection amplifier and vertical deflection oscillator in television receivers. When so operated, it is recommended that unit No.1 (pins 4, 5, and 6) be used as the oscillator. Outline 22, OUTLINES SECTION. Tube requires octal socket and may be mounted in any position.

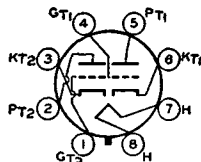

## 6BX7-GT

5, and 6) be used as the oscillator. Outline 22, OUTLINES SECTION. Tube requires octal socket and may be mounted in any position.

HEATER VOLTAGE (AC/DC).....	6.3	volts
HEATER CURRENT.....	1.5	amperes
AMPLIFICATION FACTOR*.....	10	
PLATE RESISTANCE (Approx.)*.....	1300	ohms
TRANSCONDUCTANCE*.....	7600	μmhos

\* For plate volts, 250; cathode-bias resistor, 390 ohms; plate ma., 42

### VERTICAL DEFLECTION OSCILLATOR OR AMPLIFIER (Each Unit)

*For operation in a 525-line, 30-frame system*

Maximum Ratings:	Oscillator	Amplifier	
DC PLATE VOLTAGE.....	500 max	500 max	volts
PEAK POSITIVE-PULSE PLATE VOLTAGE (Absolute Maximum)†.....	-	2000*max	volts
PEAK NEGATIVE-PULSE GRID VOLTAGE.....	400 max	250 max	volts
CATHODE CURRENT:			
Peak.....	180 max	180 max	ma
Average.....	60 max	60 max	ma
PLATE DISSIPATION:			
For either plate.....	10 max	10 max	watts
For both plates with both units operating.....	12 max	12 max	watts
PEAK HEATER-CATHODE VOLTAGE:			
Heater negative with respect to cathode.....	200 max	200 max	volts
Heater positive with respect to cathode.....	200°max	200°max	volts

#### Maximum Circuit Values:

Grid-Circuit Resistance.....	2.2 max	2.2 max	megohms
------------------------------	---------	---------	---------

† The duration of the voltage pulse must not exceed 15 per cent of one vertical scanning cycle. In a 525-line, 30-frame system, 15 per cent of one vertical scanning cycle is 2.5 milliseconds.

\* Under no circumstances should this absolute value be exceeded.

° The dc component must not exceed 100 volts.

**FULL-WAVE VACUUM RECTIFIER**

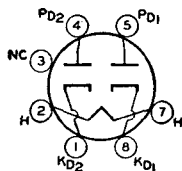

Octal type having high perveance used as a damper tube in horizontal deflection circuits of television receivers or as a rectifier in conventional power-supply applications. Outline 31, OUTLINES SECTION. Tube requires octal socket and may be mounted in any position. It is especially important that this tube, like other power-handling tubes, be adequately ventilated.

**6BY5-GA**

Heater volts (ac/dc), 6.3; amperes, 1.6. Maximum ratings for damper service (each unit): peak inverse plate volts, 3000 *max*; peak plate ma., 525 *max*; dc plate ma., 175 *max*. Peak heater-cathode volts: heater negative with respect to cathode, 450 *max*; heater positive with respect to cathode, 100 *max*. This type is used principally for renewal purposes.

**PENTAGRID AMPLIFIER**

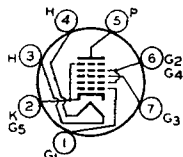

Miniature type used as a gated amplifier in color television receivers. In such service, it may be used as a combined sync separator and sync clipper. Outline 11, OUTLINES SECTION.

**6BY6**

Tube requires miniature seven-contact socket and may be mounted in any position.

HEATER VOLTAGE (AC/DC).....	6.3	volts
HEATER CURRENT.....	0.3	ampere
DIRECT INTERELECTRODE CAPACITANCES:		
Grid No.1 to Plate.....	0.08 <i>max</i>	$\mu$ f
Grid No.3 to Plate.....	0.35 <i>max</i>	$\mu$ f
Grid No.1 to Grid No.3.....	0.15 <i>max</i>	$\mu$ f
Grid No.1 to All Other Electrodes.....	5.4	$\mu$ f
Grid No.3 to All Other Electrodes.....	6.9	$\mu$ f
Plate to All Other Electrodes.....	7.6	$\mu$ f

**Characteristics:**

**CLASS A<sub>1</sub> AMPLIFIER**

Plate Voltage.....	250	volts
Grids-No.2-and-No.4 Voltage.....	100	volts
Grid-No.3 Voltage.....	-2.5	volts
Grid-No.1 Voltage.....	-2.5	volts
Grid-No.3-to-Plate Transconductance.....	500	$\mu$ mhos
Grid-No.1-to-Plate Transconductance.....	1900	$\mu$ mhos
Plate Current.....	6.5	ma
Grids-No.2-and-No.4 Current.....	9	ma
Grid-No.3 Volts (Approx.) for plate current of 35 $\mu$ a and grid-No.1 volts =-4.....	-15	volts
Grid-No.1 Volts (Approx.) for plate current of 35 $\mu$ a and grid-No.3 volts =0.....	-12	volts

**Maximum Ratings:**

**GATED AMPLIFIER SERVICE**

PLATE VOLTAGE.....	300 <i>max</i>	volts
GRIDS-NO.2-AND-NO.4 VOLTAGE.....	See curve page 67	
GRIDS-NO.2-AND-NO.4 SUPPLY VOLTAGE.....	300 <i>max</i>	volts
GRID-NO.3 SUPPLY VOLTAGE:		
Negative bias value.....	50 <i>max</i>	volts
Positive bias value.....	0 <i>max</i>	volts
Positive peak value.....	25 <i>max</i>	volts
GRID-NO.1 SUPPLY VOLTAGE:		
Negative bias value.....	100 <i>max</i>	volts
PLATE DISSIPATION.....	2 <i>max</i>	watts
GRID-NO.3 INPUT.....	0.1 <i>max</i>	watt
GRIDS-NO.2-AND-NO.4 INPUT:		
For grids-No.2-and-No.4 voltages up to 150 volts.....	1 <i>max</i>	watt
For grids-No.2-and-No.4 voltages between 150 and 300 volts.....	See curve page 67	
GRID-NO.1 INPUT.....	0.1 <i>max</i>	watt
PEAK HEATER-CATHODE VOLTAGE:		
Heater negative with respect to cathode.....	200 <i>max</i>	volts
Heater positive with respect to cathode.....	200° <i>max</i>	volts

**Characteristics as Sync Separator and Sync Clipper:**

Plate Voltage.....	10	volts
Grid-No.3 Voltage.....	0	volts
Grids-No.2-and-No.4 Voltage.....	25	volts

Grid-No.1 Voltage .....	0	volts
Plate Current .....	1.4	ma
Grids-No.2-and-No.4 Current .....	3.5	ma
Grid-No.3 Volts (Approx.) for plate voltage of 25 volts, grids-No.2-and-No.4 voltage of 25 volts, grid-No.1 voltage of 0 volts, and plate current of 50 $\mu$ a	-2.5	volts
Grid-No.1 Volts (Approx.) for plate voltage of 25 volts, grids-No.2-and-No.4 voltage of 25 volts, grid-No.3 voltage of 0 volts, and plate current of 50 $\mu$ a	-2.3	volts

**Maximum Circuit Values:**

**Grid-No.1 or Grid-No.3-Circuit Resistance:**

For fixed-bias operation .....	0.5 max	megohm
For cathode-bias operation .....	1.0 max	megohm

\* The dc component must not exceed 100 volts.

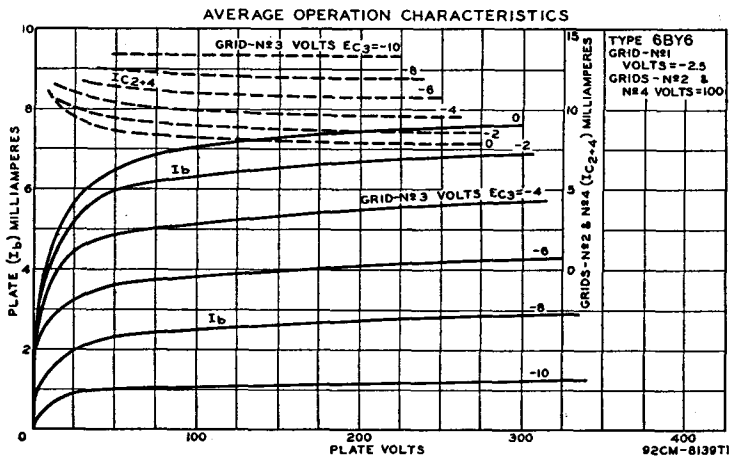
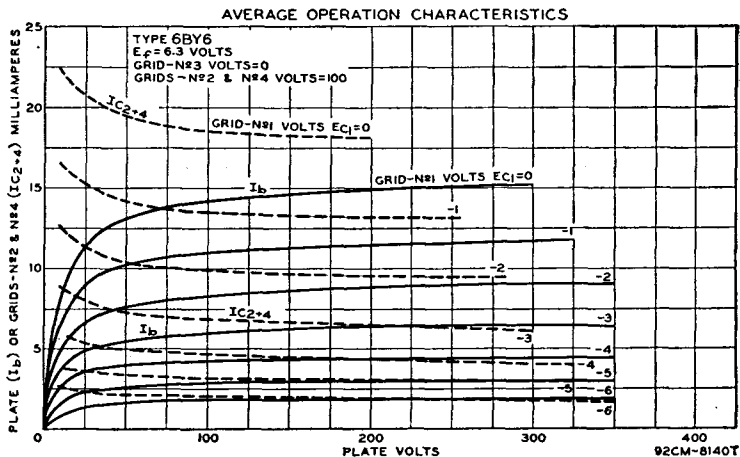

## SEMIREMOTE-CUTOFF PENTODE

# 6BZ6

Miniature type used in gain-controlled video if stages of television receivers. Outline 11, OUTLINES SECTION. Tube requires miniature seven-contact socket and may be mounted in any position.

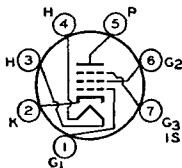



## RCA Receiving Tube Manual

HEATER VOLTAGE (AC/DC) .....	6.3	volts
HEATER CURRENT .....	0.3	ampere

DIRECT INTERELECTRODE CAPACITANCES:	Without External Shield	With External Shield	
Grid No.1 to Plate .....	0.02 max	0.015 max	$\mu\text{f}$
Grid No.1 to Cathode, Heater, Grid No.2, Grid No.3, and Internal Shield .....	7.5	7.5	$\mu\text{f}$
Plate to Cathode, Heater, Grid No.2, Grid No.3, and In- ternal Shield .....	1.8	2.8	$\mu\text{f}$

### CLASS A<sub>1</sub> AMPLIFIER

#### Maximum Ratings:

PLATE VOLTAGE .....	300 max	volts
GRID-NO.3 (SUPPRESSOR-GRID) VOLTAGE .....	0 max	volts
GRID-NO.2 (SCREEN-GRID) SUPPLY VOLTAGE .....	300 max	volts
GRID-NO.2 VOLTAGE .....	See curve page 67	
GRID-NO.1 (CONTROL-GRID) VOLTAGE:		
Positive bias value .....	0 max	volts
PLATE DISSIPATION .....	2.5 max	watts
GRID-NO.2 INPUT:		
For grid-No.2 voltages up to 150 volts .....	0.5 max	watt
For grid-No.2 voltages between 150 and 300 volts .....	See curve page 67	
PEAK HEATER-CATHODE VOLTAGE:		
Heater negative with respect to cathode .....	200 max	volts
Heater positive with respect to cathode .....	200 max	volts

#### Characteristics:

Plate Supply Voltage .....	200	volts
Grid No.3 .....	Connected to cathode at socket	
Grid No.2 Supply Voltage .....	150	volts
Cathode-Bias Resistor .....	180	ohms
Plate Resistance (Approx.) .....	0.6	megohm
Transconductance .....	6100	$\mu\text{mhos}$
Grid-No.1 Voltage (Approx.) for transconductance of 50 $\mu\text{mhos}$ .....	-23	volts
Plate Current .....	11	ma
Grid-No.2 Current .....	2.6	ma

#### Maximum Circuit Values:

For fixed-bias operation .....	0.25 max	megohm
For cathode-bias operation .....	1.0 max	megohm

• The dc component must not exceed 100 volts.

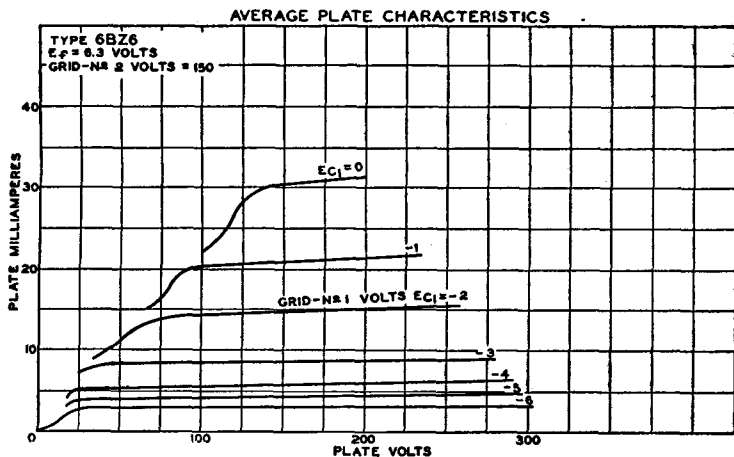

92CM-8506T

**MEDIUM-MU TWIN TRIODE**

**6BZ7**

Miniature type used as rf amplifier in tuners of vhf television receivers or as low-noise if pre-amplifier tube in uhf television receivers employing a crystal mixer. Especially useful in the

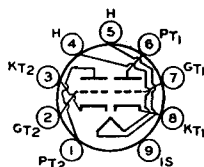

rf stage of television receivers utilizing a cathode-drive amplifier of the direct-coupled type or in push-pull cathode-drive rf amplifiers. Outline 12, OUTLINES SECTION. Tube requires miniature nine-contact socket and may be mounted in any position.

HEATER VOLTAGE (AC/DC) .....	6.3	volts
HEATER CURRENT .....	0.4	ampere

**Maximum Ratings: CLASS A<sub>1</sub> AMPLIFIER (Each Unit)**

PLATE VOLTAGE .....	250*max	volts
PLATE DISSIPATION .....	2.0 max	watts
CATHODE CURRENT .....	20 max	ma
PEAK HEATER-CATHODE VOLTAGE:		
Heater negative with respect to cathode .....	200*max	volts
Heater positive with respect to cathode .....	200max	volts

\* In cathode-drive circuits with direct-coupled drive, it is permissible for this voltage to be as high as 300 volts.

■ The dc component must not exceed 100 volts.

**Characteristics:**

Plate Supply Voltage .....	150	volts
Cathode-Bias Resistor .....	220	ohms
Amplification Factor .....	38	
Plate Resistance (Approx.) .....	5600	ohms
Transconductance .....	6800	μmhos
Plate Current .....	10	ma
Grid Voltage (Approx.) for plate current of 10 μa .....	-11	volts

**Maximum Circuit Value:**

Grid-Circuit Resistance .....	0.5 max	megohm
-------------------------------	---------	--------

**POWER TRIODE**

**6C4**

Miniature type used in compact radio equipment as a local oscillator in FM and other high-frequency circuits. It may also be used as a class C rf amplifier. In such service, it delivers

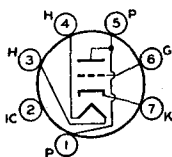

a power output of 5.5 watts at moderate frequencies, and 2.5 watts at 150 megacycles per second. Outline 11, OUTLINES SECTION. Tube requires miniature seven-contact socket and may be mounted in any position. For typical operation as a resistance-coupled amplifier, refer to Chart 10, RESISTANCE-COUPLED AMPLIFIER SECTION. For heater and cathode considerations, refer to type 6AV6. For additional curve of plate characteristics, refer to type 12AU7.

HEATER VOLTAGE (AC/DC) .....	6.3	volts
HEATER CURRENT .....	0.15	ampere
DIRECT INTERELECTRODE CAPACITANCES:		
Grid to Plate .....	1.6	μf
Grid to Cathode and Heater .....	1.8	μf
Plate to Cathode and Heater .....	1.3	μf

**Maximum Ratings: CLASS A<sub>1</sub> AMPLIFIER**

PLATE VOLTAGE .....	300 max	volts
PLATE DISSIPATION .....	3.5 max	watts
PEAK HEATER-CATHODE VOLTAGE:		
Heater negative with respect to cathode .....	200 max	volts
Heater positive with respect to cathode .....	200max	volts

**Characteristics:**

Plate Voltage .....	100	250	volts
Grid Voltage .....	0	-8.5	volts

# RCA Receiving Tube Manual

Amplification Factor .....	19.5	17	
Plate Resistance .....	6250	7700	ohms
Transconductance .....	3100	2200	$\mu$ mhos
Plate Current .....	11.8	10.5	ma

### Maximum Circuit Value:

Grid-Circuit Resistance:		
For fixed-bias operation .....	0.25 max	megohm
For cathode-bias operation .....	1.0 max	megohm

■ The dc component must not exceed 100 volts.

### RF POWER AMPLIFIER AND OSCILLATOR—Class C Telegraphy

#### Maximum Ratings:

DC PLATE VOLTAGE .....	300 max	volts
DC GRID VOLTAGE .....	-50 max	volts
DC PLATE CURRENT .....	25 max	ma
DC GRID CURRENT .....	8 max	ma
PLATE DISSIPATION .....	5 max	watts

#### Typical Operation (At Moderate Frequencies):

DC Plate Voltage .....	300	volts
DC Grid Voltage .....	-27	volts
DC Plate Current .....	25	ma
DC Grid Current (Approx.) .....	7	ma
Driving Power (Approx.) .....	0.35	watt
Power Output (Approx.) .....	5.5	watts

### AVERAGE PLATE CHARACTERISTICS

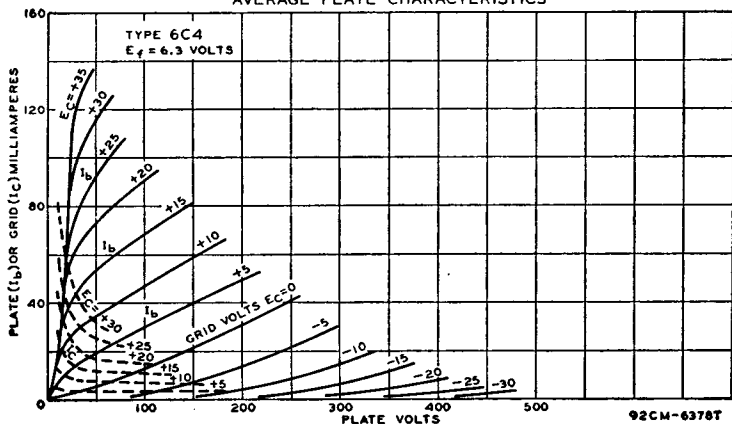

### MEDIUM-MU TRIODE

Metal type 6C5 and glass octal type 6C5-GT used as audio amplifier and oscillator. They are also used as detectors of grid-resistor-and-capacitor type or grid-bias type. Outlines 3 and 25, respectively, OUTLINES SECTION. Tubes require octal socket and may be mounted in any position. Heater volts (ac/dc), 6.3; amperes, 0.3. Maximum ratings as class A<sub>1</sub> amplifier:

## 6C5 6C5-GT

plate volts, 300 max; plate dissipation, 2.5 max watts; grid volts, 0 min. Typical operation: plate volts, 250; grid volts, -8 (grid-circuit resistance should not exceed 1.0 megohm); amplification factor, 20; plate resistance, 10000 ohms; transconductance, 2000  $\mu$ mhos; plate ma., 8. For typical operation as a resistance-coupled amplifier, refer to Chart 11, RESISTANCE-COUPLED AMPLIFIER SECTION. Type 6C5-GT is used principally for renewal purposes.

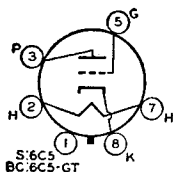

### SHARP-CUTOFF PENTODE

Glass type used as biased detector and as a high-gain amplifier in radio equipment. Outline 44, OUTLINES SECTION. Tube requires six-contact socket. Heater volts (ac/dc), 6.3; amperes, 0.3. For ratings and typical operation data, refer to type 6J7. Type 6C6 is used principally for renewal purposes.

## 6C6

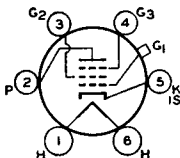

**TWIN DIODE—  
MEDIUM-MU TRIODE**

**6C7**

Glass type used as combined detector, amplifier, and avc tube. Outline 39, OUTLINES SECTION. Heater volts (ac/dc), 6.3; amperes, 0.3. This type is similar to, but not interchangeable with, type 85. The 6C7 is a DISCONTINUED type listed for reference only.

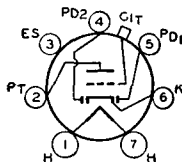

**MEDIUM-MU TWIN TRIODE**

**6C8-G**

Glass octal type used as a voltage amplifier and phase inverter in radio equipment. Outline 38, OUTLINES SECTION. When this type is used in a high-gain amplifier, hum may be reduced or eliminated by grounding pin No.7 or by grounding the arm of a 100-to-500-ohm potentiometer across the heater terminals. Tube requires octal socket. Heater volts (ac/dc), 6.3;

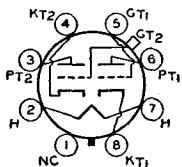

amperes, 0.3. Maximum ratings for each triode unit as class A<sub>1</sub> amplifier: plate volts, 250 max; grid volts, 0 min; plate dissipation, 1.0 max watt. Typical operation: plate volts, 250; grid volts, -4.5; plate ma., 3.2; plate resistance, 22500 ohms; amplification factor, 36; transconductance, 1600 μmhos. For typical operation as a resistance-coupled amplifier, refer to Chart 12, RESISTANCE-COUPLED AMPLIFIER SECTION. This type is used principally for renewal purposes.

**BEAM POWER TUBE**

**6CB5  
6CB5-A**

Glass octal types used as horizontal deflection amplifiers in color television receivers. Outlines 49 and 45, respectively, OUTLINES SECTION. Tubes require octal socket and may be mounted in any position.

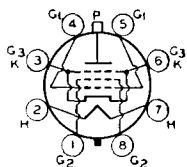

HEATER VOLTAGE (AC/DC) .....	6.3	volts
HEATER CURRENT .....	2.5	amperes
DIRECT INTERELECTRODE CAPACITANCES (Approx.):		
Grid No.1 to plate .....	0.4	μf
Grid No.1 to Cathode, Heater, Grid No.2, and Grid No.3 .....	22	μf
Plate to Cathode, Heater, Grid No.2, and Grid No.3 .....	10	μf
TRANSCONDUCTANCE* .....	8800	μmhos
MU-FACTOR, Grid No.2 to Grid No.1* .....	3.8	

\*For plate and grid-No.2 volts, 175; grid-No.1 volts, -30; plate ma., 90; grid-No.2 ma., 6.

AVERAGE PLATE CHARACTERISTICS  
WITH  $E_{C1}$  AS VARIABLE

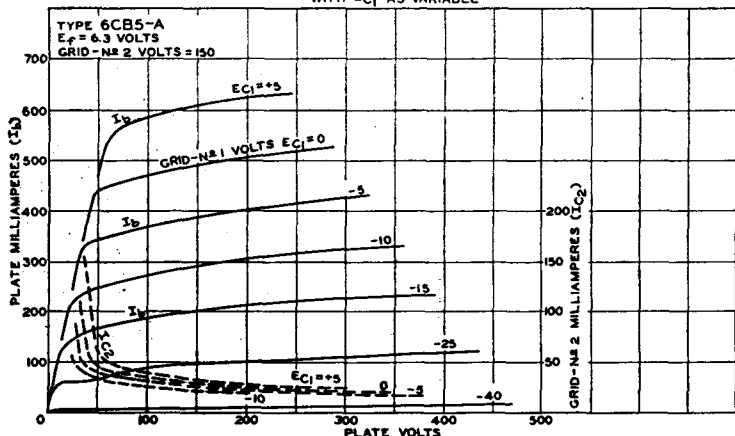

92CM-8436T1

## HORIZONTAL DEFLECTION AMPLIFIER

For operation in a 525-line, 30-frame system

### Maximum Ratings:

	6CB5	6CB5-A	
DC PLATE VOLTAGE.....	700 max	800 max	volts
PEAK POSITIVE-PULSE PLATE VOLTAGE <sup>‡</sup> (Absolute Maximum).....	6800 <sup>o</sup> max	6800 <sup>o</sup> max	volts
PEAK NEGATIVE-PULSE PLATE VOLTAGE.....	-1500 max	-1500 max	volts
DC GRID-NO.2 (SCREEN-GRID) VOLTAGE.....	200 max	200 max	volts
DC GRID-NO.1 (CONTROL-GRID) VOLTAGE.....	-50 max	-50 max	volts
PEAK NEGATIVE-PULSE GRID-NO.1 VOLTAGE.....	-200 max	-200 max	volts
<b>CATHODE CURRENT:</b>			
Peak.....	700 max	770 max	ma
Average.....	200 max	220 max	ma
GRID-NO.2 INPUT.....	3.6 max	3.6 max	watts
PLATE DISSIPATION.....	23 max	23 max	watts
<b>PEAK HEATER-CATHODE VOLTAGE:</b>			
Heater negative with respect to cathode.....	200 max	200 max	volts
Heater positive with respect to cathode.....	200 <sup>■</sup> max	200 <sup>■</sup> max	volts
BULB TEMPERATURE (At hottest point).....	220 max	220 max	°C

### Maximum Circuit Value:

Grid-No.1-Circuit Resistance..... 0.47 max megohm

<sup>‡</sup> The duration of the voltage pulse must not exceed 15 per cent of one horizontal scanning cycle. In a 525-line, 30-frame system, 15 per cent of one horizontal scanning cycle is 10 microseconds.

<sup>o</sup> Under no circumstances should this absolute value be exceeded.

<sup>†</sup> An adequate bias resistor or other means is required to protect the tube in the absence of excitation.

<sup>■</sup> The dc component must not exceed 100 volts.

AVERAGE PLATE CHARACTERISTICS  
WITH  $E_{C2}$  AS VARIABLE

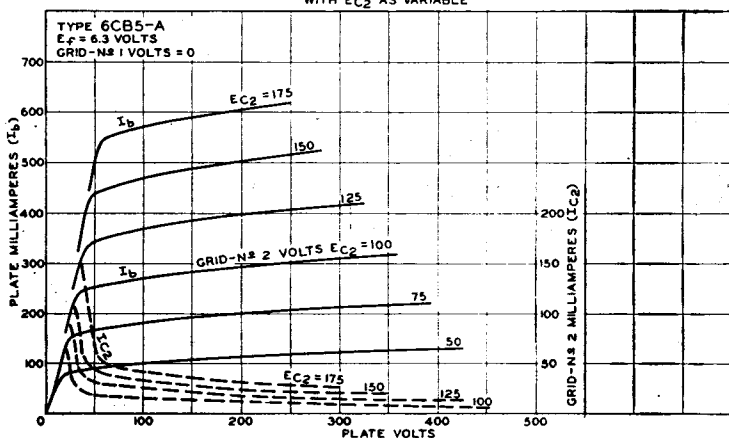

92CM-843771

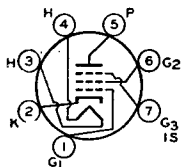

## SHARP-CUTOFF PENTODE

Miniature type used in television receivers as an intermediate-frequency amplifier at frequencies up to about 45 megacycles per second and as an rf amplifier in vhf television tuners. Tube

# 6CB6

features very high transconductance combined with low interelectrode capacitance values, and is provided with separate base pins for grid No.3 and the cathode to permit the use of an unbypassed cathode resistor to minimize the effects of regeneration. Outline 11, OUTLINES SECTION. Tube requires miniature seven-contact socket and may be mounted in any position. For heater and cathode considerations, refer to type 6AV6.

HEATER VOLTS (AC/DC).....	6.3	volts
HEATER CURRENT.....	0.3	ampere
<b>DIRECT INTERELECTRODE CAPACITANCES:</b>		
Grid No.1 to Plate.....	0.020 max	μf
Grid No.1 to Cathode, Heater, Grid No.2, Grid No.3, and Internal Shield..	6.5	μf
Plate to Cathode, Heater, Grid No.2, Grid No.3, and Internal Shield.....	2.0	μf

**Maximum Ratings:**
**CLASS A<sub>1</sub> AMPLIFIER**

PLATE VOLTAGE.....	300 max	volts
GRID-NO.2 (SCREEN-GRID) VOLTAGE.....	See curve page 67	
GRID-NO.2 SUPPLY VOLTAGE.....	300 max	volts
PLATE DISSIPATION.....	2.0 max	watts
GRID-NO.2 INPUT:		
For grid-No.2 voltages up to 150 volts.....	0.5 max	watt
For grid-No.2 voltages between 150 and 300 volts.....	See curve page 67	
PEAK HEATER-CATHODE VOLTAGE:		
Heater negative with respect to cathode.....	200 max	volts
Heater positive with respect to cathode.....	200 <sup>o</sup> max	volts

**Characteristics:**

Plate Supply Voltage.....	200	volts
Grid-No.3 (Suppressor Grid).....	Connected to cathode at socket	
Grid-No.2 Supply Voltage.....	150	volts
Cathode-Bias Resistor.....	180	ohms
Plate Resistance (Approx.).....	0.6	megohm
Transconductance.....	6200	$\mu$ mhos
Grid-No.1 Voltage (Approx.) for plate current of 10 $\mu$ a.....	-8	volts
Plate Current.....	9.5	ma
Grid-No.2 Current.....	2.8	ma

<sup>o</sup> The dc component must not exceed 100 volts.

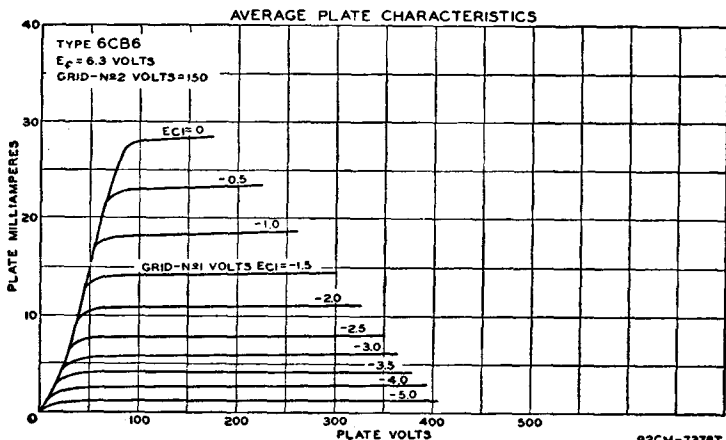

## 6CD6-G

### BEAM POWER TUBE

## 6CD6-GA

Glass octal types used as horizontal deflection amplifiers in high-efficiency deflection circuits of television receivers employing either transformer coupling or direct coupling to the deflection yoke. Outlines 53 and 45, respectively, OUTLINES SECTION. Tubes require octal socket. Vertical tube mounting is preferred but horizontal operation is permissible if pins No.2 and 7 are in vertical plane. Type 6CD6-G has a maximum peak positive-pulse plate voltage of 6600 volts and a maximum plate dissipation of 15 watts. Type 6CD6-G is used principally for renewal purposes.

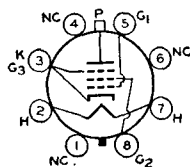

deflection yoke. Outlines 53 and 45, respectively, OUTLINES SECTION. Tubes require octal socket. Vertical tube mounting is preferred but horizontal operation is permissible if pins No.2 and 7 are in vertical plane. Type 6CD6-G has a maximum peak positive-pulse plate voltage of 6600 volts and a maximum plate dissipation of 15 watts. Type 6CD6-G is used principally for renewal purposes.

HEATER VOLTAGE (AC/DC).....	6.8	volts
HEATER CURRENT.....	2.5	amperes
DIRECT INTERELECTRODE CAPACITANCES (Approx.):		
Grid No.1 to Plate.....	1.1 max	$\mu$ mf
Grid No.1 to Cathode, Heater, Grid No.2, and Grid No.3.....	22	$\mu$ mf
Plate to Cathode, Heater, Grid No.2, and Grid No.3.....	8.5	$\mu$ mf
TRANSCONDUCTANCE <sup>o</sup> .....	7700	$\mu$ mhos
MU-FACTOR, Grid No.2 to Grid No.1 <sup>o</sup> .....	8.9	

<sup>o</sup> For plate and grid-No.2 volts, 175; grid-No.1 volts, -30.

# RCA Receiving Tube Manual

## HORIZONTAL DEFLECTION AMPLIFIER

For operation in a 525-line, 30-frame system

### Maximum Ratings:

DC PLATE VOLTAGE.....	700 max	volts
PEAK POSITIVE-PULSE PLATE VOLTAGE* (Absolute Maximum).....	7000 <sup>max</sup>	volts
PEAK NEGATIVE-PULSE PLATE VOLTAGE.....	-1500 max	volts
DC GRID-NO.2 (SCREEN-GRID) VOLTAGE.....	175 max	volts
DC GRID-NO.1 (CONTROL-GRID) VOLTAGE.....	-50 max	volts
PEAK NEGATIVE-PULSE GRID-NO.1 VOLTAGE.....	-200 max	volts
CATHODE CURRENT:		
Peak.....	700 max	ma
Average.....	200 max	ma
PLATE DISSIPATION†.....	20 max	watts
GRID-NO.2 INPUT.....	3 max	watts
PEAK HEATER-CATHODE VOLTAGE:		
Heater negative with respect to cathode.....	200 max	volts
Heater positive with respect to cathode.....	200 <sup>max</sup>	volts
BULB TEMPERATURE (At hottest point).....	225 max	°C

### Maximum Circuit Value:

Grid-No.1-Circuit Resistance..... 1.0 max megohm

\* The duration of the voltage pulse must not exceed 15 per cent of one horizontal scanning cycle. In a 525-line, 30-frame system, 15 per cent of one horizontal scanning cycle is 10 microseconds.

† Under no circumstances should this absolute value be exceeded.

‡ An adequate bias resistor or other means is required to protect the tube in the absence of excitation.

° The dc component must not exceed 100 volts.

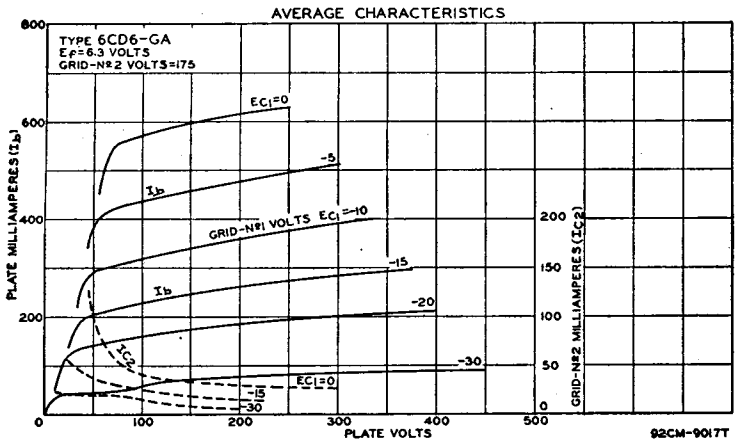
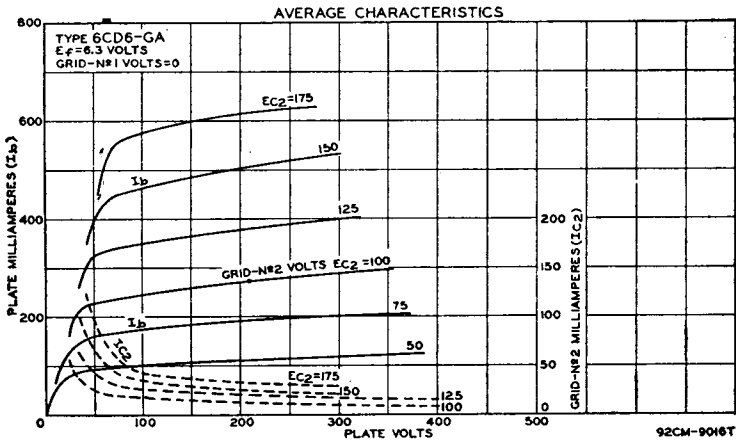

# 6CF6

## SHARP-CUTOFF PENTODE

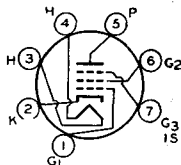

Miniature type used in television receivers as an intermediate-frequency amplifier at frequencies up to about 45 megacycles per second and as an rf amplifier in vhf television tuners. Because of its plate-current cutoff characteristic, this type is used in gain-controlled stages of video if amplifiers. This type is identical with miniature type 6CB6 except that the grid-No.1 voltage (approx.) for plate current of 35 microamperes is -6.5 volts. Outline 11, OUTLINES SECTION. Heater volts (ac/dc), 6.3; amperes, 0.3.

# 6CG7

## MEDIUM-MU TWIN TRIODE

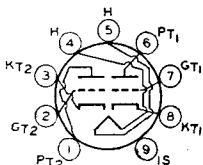

Miniature type used as vertical deflection oscillator and horizontal deflection oscillator in television receivers employing series-connected heater strings. Also used as phase inverter, sync separator and amplifier, and resistance-coupled amplifier in radio equipment. Except for the common heater, each triode unit is independent of the other. For typical operation as phase inverter or resistance-coupled amplifier, refer to Chart 13, RESISTANCE-COUPLED AMPLIFIER SECTION.

HEATER VOLTAGE (AC/DC) .....	6.3	volts
HEATER CURRENT .....	0.6	ampere
HEATER WARM-UP TIME (Average) .....	11	seconds
DIRECT INTERELECTRODE CAPACITANCES (Each Unit, Approx.):		
Grid to Plate .....	4.0	$\mu\mu\text{f}$
Grid to Cathode, Heater, and Internal Shield .....	2.3	$\mu\mu\text{f}$
Plate to Cathode, Heater, and Internal Shield .....	2.2	$\mu\mu\text{f}$

### CLASS A<sub>1</sub> AMPLIFIER (Each Unit)

<b>Maximum Ratings:</b>		
PLATE VOLTAGE .....	300 max	volts
GRID VOLTAGE:		
Positive bias value .....	0 max	volts
PLATE DISSIPATION:		
For either plate .....	3.5 max	watts
For both plates with both units operating .....	5 max	watts
CATHODE CURRENT .....	20 max	ma
PEAK HEATER-CATHODE VOLTAGE:		
Heater negative with respect to cathode .....	200 max	volts
Heater positive with respect to cathode .....	200 max	volts

### Characteristics:

Plate Voltage .....	90	250	volts
Grid Voltage .....	0	-8	volts
Amplification Factor .....	20	20	
Plate Resistance (Approx.) .....	6700	7700	ohms
Transconductance .....	3000	2600	$\mu\text{mhos}$
Grid Voltage (Approx.) for plate current of 10 $\mu\text{a}$ .....	-7	-18	volts
Plate Current for grid voltage of -12.5 volts .....	-	1.3	ma
Plate Current .....	10	9	ma

### Maximum Circuit Value:

Grid-Circuit Resistance:		
For fixed-bias operation .....	1.0 max	megohm

■ The dc component must not exceed 100 volts.

### OSCILLATOR

For operation in a 525-line, 30-frame system

	Vertical Deflection Oscillator	Horizontal Deflection Oscillator	
Maximum Ratings (Each Unit):			
DC PLATE VOLTAGE .....	300 max	300 max	volts
PEAK NEGATIVE-PULSE GRID VOLTAGE .....	-400 max	-600 max	volts



<b>CATHODE CURRENT:</b>			
Peak.....	70 max	300 max	ma
Average.....	20 max	20 max	ma
<b>PLATE DISSIPATION:</b>			
For either plate.....	3.5 max	3.5 max	watts
For both plates with both units operating.....	5 max	5 max	watts
<b>PEAK HEATER-CATHODE VOLTAGE:</b>			
Heater negative with respect to cathode.....	200 max	200 max	volts
Heater positive with respect to cathode.....	200 max	200 max	volts
<b>Maximum Circuit Value:</b>			
Grid-Circuit Resistance.....	2.2 max	2.2 max	megohms

■ The dc component must not exceed 100 volts.

## INSTALLATION AND APPLICATION

Type 6CG7 requires a miniature nine-contact socket and may be mounted in any position. Outline 14, OUTLINES SECTION. This type is designed with a 600-milliamper heater having a controlled warm-up time to insure dependable performance in television receivers employing series-connected heater strings. Heater warm-up

time is measured in the circuit shown above as follows: The heater is placed in series with a resistance having a value 3 times the nominal heater operating resistance ( $R=3 E_t/I_t$ ). A voltage having a value 4 times the rated heater voltage ( $V=4 E_t$ ) is then applied. The warm-up time is the time required for the voltage across the heater to reach 80 per cent of the rated value ( $E=0.8 E_t$ ).

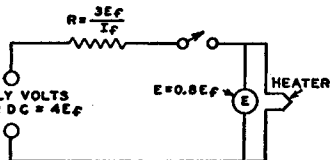

$E_f$  = RATED HEATER VOLTAGE  
 $I_f$  = RATED HEATER CURRENT

92CS-8503

AVERAGE PLATE CHARACTERISTICS  
FOR EACH UNIT

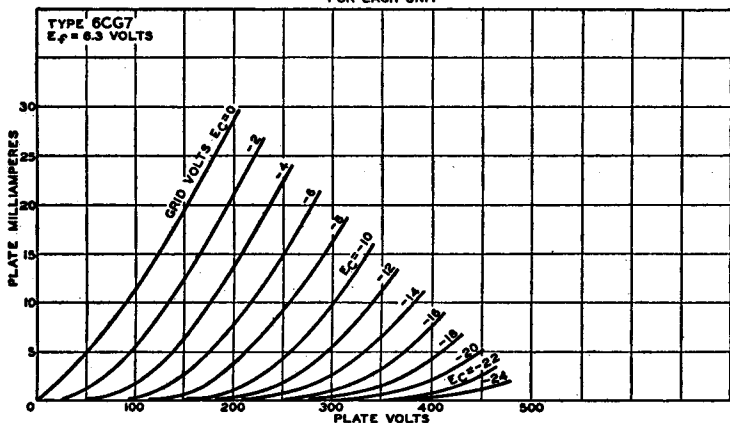

92CM-8442T

### TRIODE-PENTODE CONVERTER

Miniature types used as combined oscillator and mixer tubes in television receivers utilizing an intermediate frequency in the order of 40 megacycles per second. When used in an AM/FM

# 6CG8 6CG8-A

receiver, the triode unit is used as an oscillator for both sections. In the AM section, the pentode unit is used as a high-gain pentode mixer; in the FM section, the pentode unit is used either as a pentode mixer or as a triode-connected mixer depending on signal-to-noise considerations. Type 6CG8-A has a controlled heater

warm-up time for use in television receivers employing series-connected heater strings. Outline 12, OUTLINES SECTION. Tubes require miniature nine-contact socket and may be mounted in any position. Heater volts (ac/dc), 6.3; amperes, 0.45; warm-up time (average) for 6CG8-A, 11 seconds. For definition of heater warm-up time and method for determining it, see type 6CG7. Maximum ratings, characteristics, and typical operating values are the same as those of miniature type 6X8 except that maximum grid-No.2 input is 0.5 watt and maximum peak heater-cathode voltage is 200 volts. When the heater is positive with respect to the cathode, the dc component of the heater-cathode voltage should not exceed 100 volts. For curves of average characteristics, see type 6X8.

**DIRECT INTERELECTRODE CAPACITANCES:**

	<i>Without External Shield</i>	<i>With External Shield<sup>o</sup></i>	
<b>Triode Unit:</b>			
Grid to Plate.....	1.5	1.5	$\mu\mu\text{f}$
Grid to Cathode, Heater, and Pentode Grid No.3.....	2.6	3.0	$\mu\mu\text{f}$
Plate to Cathode, Heater, and Pentode Grid No.3.....	0.05	1.0	$\mu\mu\text{f}$
<b>Pentode Unit:</b>			
Grid No.1 to Plate.....	0.03 max	0.016 max	$\mu\mu\text{f}$
Grid No.1 to Cathode, Heater, Grid No.2, and Grid No.3	4.8	5.0	$\mu\mu\text{f}$
Plate to Cathode, Heater, Grid No.2, and Grid No.3...	0.9	1.6	$\mu\mu\text{f}$
Pentode Grid No.1 to Triode Plate.....	0.05 max	0.04 max	$\mu\mu\text{f}$
Pentode Plate to Triode Plate.....	0.05 max	0.007 max	$\mu\mu\text{f}$
Heater to Cathode.....	5.5	5.5*	$\mu\mu\text{f}$

<sup>o</sup> External shield connected to cathode except as indicated.  
\* External shield connected to ground.

**MEDIUM-MU TRIODE—  
SHARP-CUTOFF PENTODE**

**6CH8**

Miniature type used in a wide variety of applications in television receivers. The pentode unit is used as an if amplifier, video amplifier, age amplifier, or reactance tube. The triode

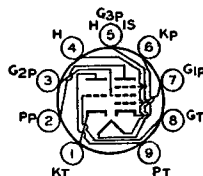

unit is used in low-frequency oscillator, sync-separator, sync-clipper, and phase-splitter circuits. Outline 12, OUTLINES SECTION. Tube requires miniature nine-contact socket and may be mounted in any position. Pin No.5 must be connected to ground to maintain the grid No.3 at ground potential. Heater volts (ac/dc), 6.3; amperes, 0.45. The heater-cathode voltage of the pentode unit (heater negative with respect to cathode) should not exceed the value of the operating cathode bias. Peak heater-cathode volts with heater positive with respect to cathode, 0 max. Other maximum ratings and characteristics are the same as those of miniature type 6AN8. For curves of average plate characteristics, refer to type 6AN8.

**DIRECT INTERELECTRODE CAPACITANCES:**

<b>Triode Unit:</b>			
Grid to Plate.....	1.6		$\mu\mu\text{f}$
Grid to Cathode, Heater, Pentode Grid No.3, and Internal Shield.....	1.9		$\mu\mu\text{f}$
Plate to Cathode, Heater, Pentode Grid No.3, and Internal Shield.....	1.6		$\mu\mu\text{f}$
<b>Pentode Unit:</b>			
Grid No.1 to Plate.....	0.025 max		$\mu\mu\text{f}$
Grid No.1 to Cathode, Heater, Grid No.2, Grid No.3, and Internal Shield	7		$\mu\mu\text{f}$
Plate to Cathode, Heater, Grid No.2, Grid No.3, and Internal Shield....	2.25		$\mu\mu\text{f}$
Triode Grid to Pentode Plate.....	0.005		$\mu\mu\text{f}$
Pentode Grid No.1 to Triode Plate.....	0.02		$\mu\mu\text{f}$
Pentode Plate to Triode Plate.....	0.04		$\mu\mu\text{f}$

**POWER PENTODE**

**6CL6**

Miniature type used in output stage of video amplifier of television receivers and as wide-band amplifier tube in industrial and laboratory equipment. Outline 14, OUTLINES SEC-

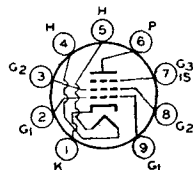

TION. Tube requires miniature nine-contact socket. Vertical tube mounting is preferred but horizontal mounting is permissible if pins No.3 and No.8 are in vertical plane.

# RCA Receiving Tube Manual

HEATER VOLTAGE (AC/DC).....	6.3	volts
HEATER CURRENT.....	0.65	ampere
DIRECT INTERELECTRODE CAPACITANCES:		
Grid No.1 to Plate.....	0.12	$\mu\mu\text{f}$
Grid No.1 to Cathode, Heater, Grid No.2, Grid No.3, and Internal Shield.....	11	$\mu\mu\text{f}$
Plate to Cathode, Heater, Grid No.2, Grid No.3, and Internal Shield....	5.5	$\mu\mu\text{f}$

<b>Maximum Ratings:</b>		<b>CLASS A<sub>1</sub> AMPLIFIER</b>
PLATE VOLTAGE.....	300 max	volts
PLATE SUPPLY VOLTAGE.....	300 max	volts
GRID-NO.3 (SUPPRESSOR-GRID) VOLTAGE.....	0 max	volts
GRID-NO.2 (SCREEN-GRID) SUPPLY VOLTAGE.....	300 max	volts
GRID-NO.2 VOLTAGE.....	150 max	volts
GRID-NO.1 (CONTROL-GRID) VOLTAGE:		
Negative bias value.....	50 max	volts
Positive bias value.....	0 max	volts
PLATE DISSIPATION.....	7.5 max	watts
GRID-NO.2 INPUT.....	1.7 max	watts
PEAK HEATER-CATHODE VOLTAGE:		
Heater negative with respect to cathode.....	90 max	volts
Heater positive with respect to cathode.....	90 max	volts
BULB TEMPERATURE (At hottest point).....	200 max	$^{\circ}\text{C}$

<b>Typical Operation:</b>		
Plate Voltage.....	250	volts
Grid-No.3 Voltage.....	Connected to cathode at socket	
Grid-No.2 Voltage.....	150	volts
Grid-No.1 Voltage.....	-3	volts
Peak AF Grid-No.1 Signal Voltage.....	3	volts
Zero-Signal DC Plate Current.....	30	ma
Maximum-Signal DC Plate Current.....	31	ma
Zero-Signal DC Grid-No.2 Current.....	7	ma
Maximum-Signal DC Grid-No.2 Current.....	7.2	ma
Plate Resistance (Approx.).....	0.09	megohm
Transconductance.....	11000	$\mu\text{mhos}$
Grid-No.1 Voltage (Approx.) for plate current of 10 $\mu\text{a}$ .....	-14	volts
Load Resistance.....	7500	ohms
Total Harmonic Distortion.....	8	per cent
Maximum-Signal Power Output.....	2.8	watts

<b>Typical Operation in 4-Mc-Bandwidth Video Amplifier:</b>		
Plate Supply Voltage.....	300	volts
Grid-No.3 Voltage.....	Connected to cathode at socket	
Grid-No.2 Supply Voltage.....	300	volts
Grid-No.1 Bias Voltage.....	-2	volts
Grid-No.1 Signal Voltage (Peak to Peak).....	3	volts
Grid-No.2 Resistor.....	24000	ohms
Grid-No.1 Resistor.....	0.1	megohm
Load Resistor.....	3900	ohms
Zero-Signal Plate Current.....	30	ma
Zero-Signal Grid-No.2 Current.....	7.0	ma
Voltage Output (Peak to Peak).....	132	volts

<b>Maximum Circuit Values (For maximum rated conditions):</b>		
Grid-No.1 Circuit Resistance:		
For fixed-bias operation.....	0.1 max	megohm
For cathode-bias operation.....	0.5 max	megohm

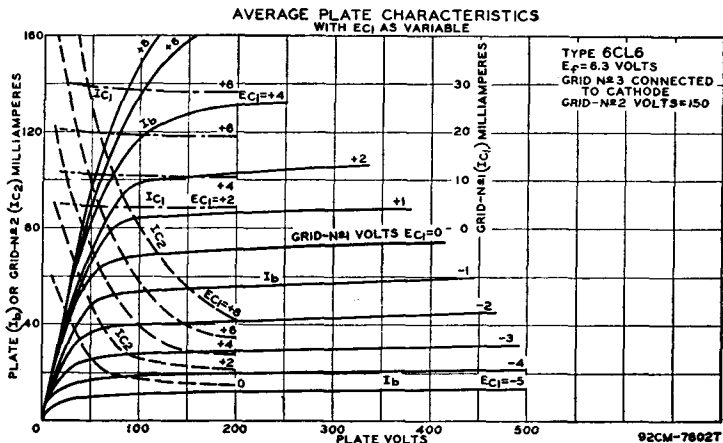

# 6CM7

## MEDIUM-MU DUAL TRIODE

Miniature type used as vertical deflection oscillator and vertical deflection amplifier in television receivers employing series-connected heater strings. Unit No.1 is used as a conventional blocking oscillator in vertical deflection circuits, and unit No.2 as a vertical deflection amplifier. Outline 14, OUTLINES SECTION. Tube requires miniature nine-contact socket and may be mounted in any position.

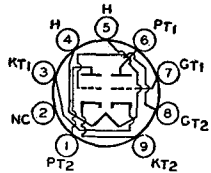

HEATER VOLTAGE (AC/DC).....	6.3	volts
HEATER CURRENT.....	0.6	ampere
HEATER WARM-UP TIME (Average)*.....	11	seconds

<b>DIRECT INTERELECTRODE CAPACITANCES (Approx.):</b>	<i>Unit No.1</i>	<i>Unit No.2</i>	
	<i>Oscillator</i>	<i>Amplifier</i>	
Grid to Plate.....	3.8	3	$\mu\text{f}$
Grid to Cathode and Heater.....	2	3.5	$\mu\text{f}$
Plate to Cathode and Heater.....	0.5	0.4	$\mu\text{f}$

\* For definition of heater warm-up time and method for determining it, refer to type 6CG7.

### VERTICAL DEFLECTION OSCILLATOR AND AMPLIFIER

For operation in a 525-line, 30-frame system

<b>Maximum Ratings:</b>	<i>Unit No.1</i>	<i>Unit No.2</i>	
	<i>Oscillator</i>	<i>Amplifier</i>	
DC PLATE VOLTAGE.....	500 max	500 max	volts
PEAK POSITIVE-PULSE PLATE VOLTAGE <sup>#</sup> (Absolute Maximum).....	-	2200 <sup>max</sup>	volts
PEAK NEGATIVE-PULSE GRID VOLTAGE.....	200 max	200 max	volts
<b>CATHODE CURRENT:</b>			
Peak.....	70 max	70 max	ma
Average.....	15 max	20 max	ma
<b>PLATE DISSIPATION.....</b>	1.25 max	5.5 max	watts
<b>PEAK HEATER-CATHODE VOLTAGE:</b>			
Heater negative with respect to cathode.....	200 max	200 max	volts
Heater positive with respect to cathode.....	200 <sup>max</sup>	200 <sup>max</sup>	volts

#### Maximum Circuit Values:

<b>Grid-Circuit Resistance:</b>		
For fixed-bias operation.....	2.2 max	1.0 max megohms
For cathode-bias operation.....	2.2 max	2.5 max megohms

<sup>#</sup> The duration of the voltage pulse must not exceed 15 per cent of one vertical scanning cycle. In a 525-line, 30-frame system, 15 per cent of one vertical scanning cycle is 2.5 milliseconds.

<sup>□</sup> Under no circumstances should this absolute value be exceeded.

<sup>▲</sup> The dc component must not exceed 100 volts.

### AVERAGE CHARACTERISTICS

UNIT #1

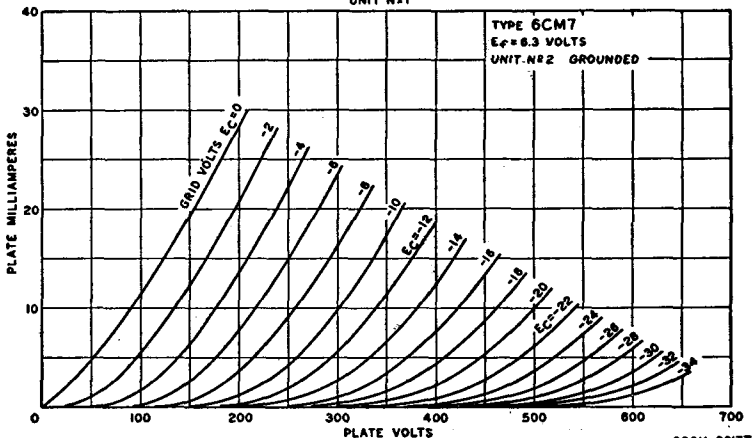

92CM-8617T

## CLASS A<sub>1</sub> AMPLIFIER

<b>Characteristics:</b>	<i>Unit No.1</i>	<i>Unit No.2</i>	
Plate Voltage.....	Oscillator	Amplifier	
Grid Voltage.....	200	250	volts
Amplification Factor.....	-7	-8	volts
Plate Resistance (Approx.).....	21	18	
Transconductance.....	10500	4100	ohms
Grid Voltage (Approx.) for plate current of 10 $\mu$ a.....	2000	4400	$\mu$ mhos
Plate Current.....	-14	-	volts
Plate Current for grid voltage of -10 volts.....	5	20	ma
	1	-	ma

AVERAGE CHARACTERISTICS  
UNIT N<sup>o</sup> 2

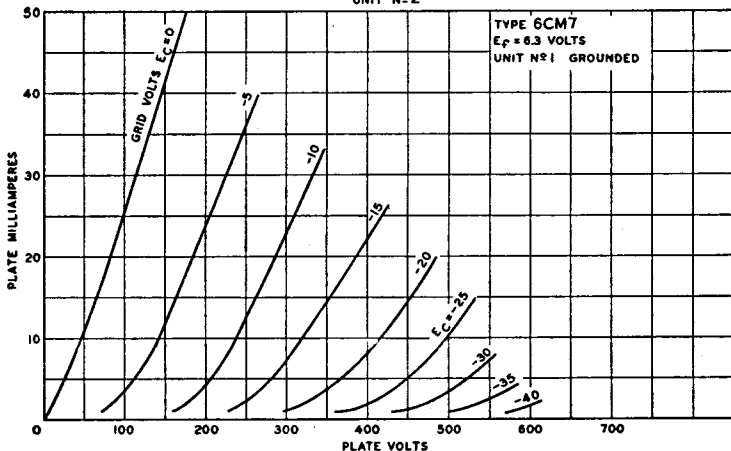

92CM-8815T

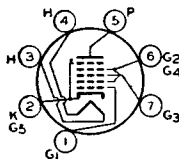

## PENTAGRID AMPLIFIER

Miniature type used as a gated amplifier in television receivers. In such service, it may be used as a combined sync separator and sync clipper. Outline 11, OUTLINES SECTION.

# 6CS6

Tube requires miniature seven-contact socket and may be mounted in any position.

HEATER VOLTAGE (AC/DC).....	6.3	volts
HEATER CURRENT.....	0.3	amperes

## CLASS A<sub>1</sub> AMPLIFIER

<b>Characteristics:</b>			
Plate Voltage.....	100	100	volts
Grids-No.2-and-No.4 Voltage.....	30	30	volts
Grid-No.3 Voltage.....	-1	0	volt
Grid-No.1 Voltage.....	0	-1	volt
Plate Resistance (Approx.).....	0.7	1	megohm
Grid-No.3-to-Plate Transconductance.....	1500	-	$\mu$ mhos
Grid-No.1-to-Plate Transconductance.....	-	1100	$\mu$ mhos
Plate Current.....	0.8	1.0	ma
Grids-No.2-and-No.4 Current.....	5.5	1.3	ma
Grid-No.3 Voltage (Approx.) for plate current of 50 $\mu$ a.....	-2.2	-	volts
Grid-No.1 Voltage (Approx.) for plate current of 50 $\mu$ a.....	-	-2.5	volts

## GATED AMPLIFIER SERVICE

### Maximum Ratings:

PLATE VOLTAGE.....	300 max	volts
GRIDS-NO.2-AND-NO.4 SUPPLY VOLTAGE.....	300 max	volts
GRIDS-NO.2-AND-NO.4 VOLTAGE.....	See curve page 67	
PLATE DISSIPATION.....	1 max	watt
GRIDS-NO.2-AND-NO.4 INPUT:		
For grids-No.2-and-No.4 voltages up to 150 volts.....	1 max	watt
For grids-No.2-and-No.4 voltages between 150 and 300 volts.....	See curve page 67	

CATHODE CURRENT.....	14 <i>max</i>	ma
PEAK HEATER-CATHODE VOLTAGE:		
Heater negative with respect to cathode.....	200 <i>max</i>	volts
Heater positive with respect to cathode.....	200 <i>max</i>	volts

### Typical Operation as Sync Separator and Sync Clipper:

Plate Voltage.....	10	volts
Grids-No.2-and-No.4 Voltage.....	30	volts
Grid-No.3 Voltage.....	0	volts
Grid-No.1 Voltage.....	0	volts
Plate Current.....	2.0	ma
Grids-No.2-and-No.4 Current.....	4.5	ma

### Maximum Circuit Values:

Grid-No.1-Circuit Resistance.....	0.47 <i>max</i>	megohm
Grid-No.3-Circuit Resistance.....	2.2 <i>max</i>	megohms

■ The dc component must not exceed 100 volts.

## BEAM POWER TUBE

Miniature type used in the audio output stage of television receivers. Outline 13, OUTLINES SECTION. Tube requires miniature seven-contact socket and may be mounted in any position.

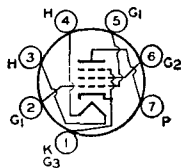

# 6CU5

HEATER VOLTAGE (AC/DC).....	6.3	volts
HEATER CURRENT.....	1.2	amperes
DIRECT INTERELECTRODE CAPACITANCES (Approx.):		
Grid No.1 to Plate.....	0.7	$\mu\text{f}$
Grid No.1 to Cathode, Heater, Grid No.2, and Grid No.3.....	13.2	$\mu\text{f}$
Plate to Cathode, Heater, Grid No.2, and Grid No.3.....	8.6	$\mu\text{f}$

### CLASS A<sub>1</sub> AMPLIFIER

Maximum Ratings:		
PLATE VOLTAGE.....	135 <i>max</i>	volts
GRID-NO.2 (SCREEN-GRID) VOLTAGE.....	117 <i>max</i>	volts
GRID-NO.1 (CONTROL-GRID) VOLTAGE:		
Positive bias value.....	0 <i>max</i>	volts
PLATE DISSIPATION.....	6 <i>max</i>	watts
GRID-NO.2 INPUT.....	1.25 <i>max</i>	watts
PEAK HEATER-CATHODE VOLTAGE:		
Heater negative with respect to cathode.....	200 <i>max</i>	volts
Heater positive with respect to cathode.....	200 <i>max</i>	volts
BULB TEMPERATURE (At hottest point).....	220 <i>max</i>	°C

### AVERAGE CHARACTERISTICS

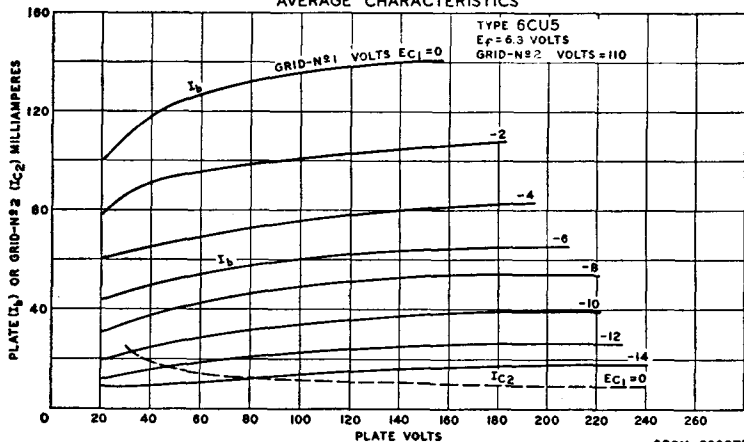

## Typical Operation:

Plate Voltage	120	volts
Grid-No.2 Voltage	110	volts
Grid-No.1 Voltage	-8	volts
Peak AF Grid-No.1 Voltage	8	volts
Zero-Signal Plate Current	49	ma
Maximum-Signal Plate Current	50	ma
Zero-Signal Grid-No.2 Current	4	ma
Maximum-Signal Grid-No.2 Current	8.5	ma
Plate Resistance (Approx.)	10000	ohms
Transconductance	7500	$\mu$ mhos
Load Resistance	2500	ohms
Total Harmonic Distortion	10	per cent
Maximum-Signal Power Output	2.3	watts

## Maximum Circuit Values:

Grid-No.1-Circuit Resistance:		
For fixed-bias operation	0.1 max	megohm
For cathode-bias operation	0.5 max	megohm

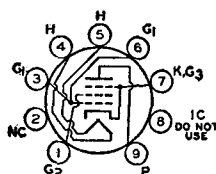

## BEAM POWER TUBE

Miniature type used as a vertical deflection amplifier in high-efficiency deflection circuits of television receivers utilizing picture tubes having diagonal deflection angles of 110 degrees

# 6CZ5

and operating at ultr voltages up to 18 kilovolts. Also used in the audio output stage of television and radio receivers. Outline 14, OUTLINES SECTION. Tube requires miniature nine-contact socket and may be mounted in any position.

HEATER VOLTAGE (AC/DC)	6.3	volts
HEATER CURRENT	0.45	ampere
DIRECT INTERELECTRODE CAPACITANCES:		
Grid No.1 to Plate	0.7 max	$\mu$ f
Grid No.1 to Cathode, Heater, Grid No.2, and Grid No.3	8	$\mu$ f
Plate to Cathode, Heater, Grid No.2, and Grid No.3	8.5	$\mu$ f

## VERTICAL DEFLECTION AMPLIFIER

*For operation in a 525-line, 30-frame system*

### Maximum Ratings:

DC PLATE VOLTAGE	3.5 max	volts
PEAK POSITIVE-PULSE PLATE VOLTAGE <sup>‡</sup> (Absolute Maximum)	2200*max	volts
GRID-NO.2 (SCREEN-GRID) VOLTAGE	285 max	volts
PEAK NEGATIVE-PULSE GRID-NO.1 (CONTROL-GRID) VOLTAGE	-250 max	volts
CATHODE CURRENT:		
Peak	140 max	ma
Average	40 max	ma
PLATE DISSIPATION	10 max	watts
GRID-NO.2 INPUT	2 max	watts
PEAK HEATER-CATHODE VOLTAGE:		
Heater negative with respect to cathode	200 max	volts
Heater positive with respect to cathode	200 max	volts
BULB TEMPERATURE (At hottest point)	250 max	°C

### Maximum Circuit Values:

Grid-No.1-Circuit Resistance:		
For fixed-bias operation	0.5 max	megohm
For cathode-bias operation	1.0 max	megohm

<sup>‡</sup> The duration of the voltage pulse must not exceed 15 per cent of one vertical scanning cycle. In a 525-line, 30-frame system, 15 per cent of one vertical scanning cycle is 2.5 milliseconds.

\* Under no circumstances should this absolute value be exceeded.

## CLASS A<sub>1</sub> AMPLIFIER

### Maximum Ratings:

PLATE VOLTAGE.....	350 max	volts
GRID-NO.2 VOLTAGE.....	285 max	volts
GRID-NO.2 INPUT.....	2 max	watts
PLATE DISSIPATION.....	12 max	watts
PEAK HEATER-CATHODE VOLTAGE:		
Heater negative with respect to cathode.....	200 max	volts
Heater positive with respect to cathode.....	200 <sup>▲</sup> max	volts

<sup>▲</sup> The dc component must not exceed 100 volts.

### Typical Operation:

Plate Voltage.....	250	volts
Grid-No.2 Voltage.....	250	volts
Grid-No.1 Voltage.....	-14	volts
Peak AF Grid-No.1 Voltage.....	13	volts
Zero-Signal Plate Current.....	46	ma
Maximum-Signal Plate Current.....	48	ma
Zero-Signal Grid-No.2 Current.....	4.6	ma
Maximum-Signal Grid-No.2 Current.....	8	ma
Plate Resistance (Approx.).....	73000	ohms
Transconductance.....	4800	μmhos
Load Resistance.....	5000	ohms
Total Harmonic Distortion.....	10	per cent
Maximum-Signal Power Output.....	5.4	watts

### Maximum Circuit Values:

Grid-No.1-Circuit Resistance:		
For fixed-bias operation.....	0.1 max	megohm
For cathode-bias operation.....	1.0 max	megohm

## PUSH-PULL CLASS AB<sub>1</sub> AMPLIFIER

### Maximum Ratings:

(Same as for single-tube Class A<sub>1</sub> Amplifier)

### Typical Operation (Values are for two tubes):

Plate Voltage.....	350	volts
Grid-No.2 Voltage.....	280	volts
Grid-No.1 Voltage.....	-23.5	volts
Peak AF Grid-No.1-to-Grid-No.1 Voltage.....	47	volts
Zero-Signal Plate Current.....	46	ma
Maximum-Signal Plate Current.....	103	ma
Zero-Signal Grid-No.2 Current.....	3	ma
Maximum-Signal Grid-No.2 Current.....	13	ma
Effective Load Resistance (Plate to plate).....	7500	ohms
Total Harmonic Distortion.....	1	per cent
Maximum-Signal Power Output.....	21.5	watts

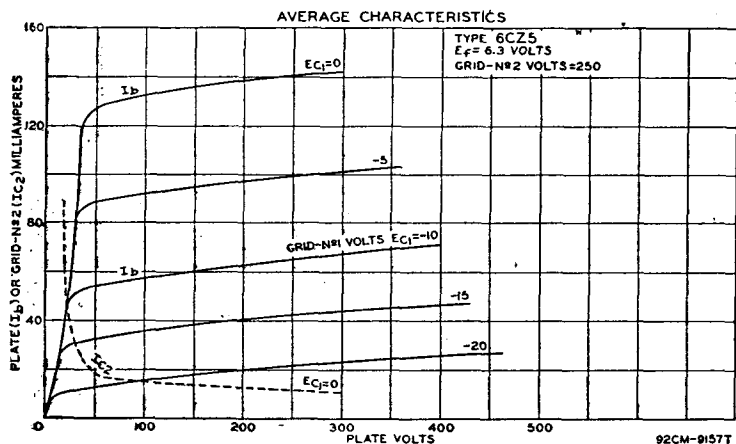



**Maximum Circuit Values:**
**Grid-No.1-Circuit Resistance:**

For fixed-bias operation.....	0.1 max	megohm
For cathode-bias operation.....	1.0 max	megohm

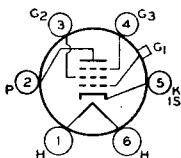

## REMOTE-CUTOFF PENTODE

Glass type used in rf and if stages of radio receivers employing avc. Outline 44, OUTLINES SECTION. Tube requires six-contact socket. Except for interelectrode capacitances, this type is identical electrically with type 6U7-G. Refer to type 6SK7 for general application information. Heater volts (ac/dc), 6.3; amperes, 0.3. This type is used principally for renewal purposes.

# 6D6

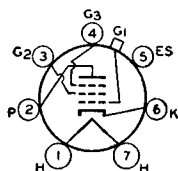

## SHARP-CUTOFF PENTODE

Glass type used as detector or amplifier in radio receivers. Outline 44, OUTLINES SECTION. Heater volts (ac/dc), 6.3; amperes, 0.3. For electrical characteristics, refer to type 6J7. Type 6D7 is a DISCONTINUED type listed for reference only.

# 6D7

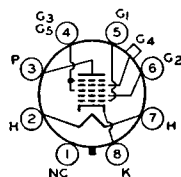

## PENTAGRID CONVERTER

Glass octal type used in superheterodyne circuits. Outline 38, OUTLINES SECTION. Tube requires octal socket. Heater volts (ac/dc), 6.3; amperes, 0.15. Except for interelectrode capacitances and heater rating, the 6D8-G is similar electrically to type 6A8-G. Type 6D8-G is a DISCONTINUED type listed for reference only.

# 6D8-G

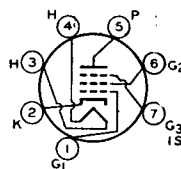

## SEMIREMOTE-CUTOFF PENTODE

Miniature type used in the gain-controlled picture if stages of color television receivers. It is also used as a radio-frequency amplifier in the tuners of such receivers. Outline 11, OUT-

# 6DC6

LINES SECTION. Tube requires seven-contact miniature socket and may be mounted in any position.

HEATER VOLTAGE (AC/DC).....	6.3	volts
HEATER CURRENT.....	0.3	ampere
<b>DIRECT INTERELECTRODE CAPACITANCES:</b>		
Grid No.1 to Plate.....	0.02 max	μf
Grid No.1 to Cathode, Heater, Grid No.2, Grid No.3, and Internal Shield.....	6.5	μμf
Plate to Cathode, Heater, Grid No.2, Grid No.3, and Internal Shield.....	2	μμf

**Maximum Ratings:**

### CLASS A<sub>1</sub> AMPLIFIER

PLATE VOLTAGE.....	800 max	volts
GRID-NO.3 (SUPPRESSOR-GRID) VOLTAGE.....	0 max	volts
GRID-NO.2 SUPPLY VOLTAGE.....	300 max	volts
GRID-NO.2 (SCREEN-GRID) VOLTAGE.....	See curve page 67	
<b>GRID-NO.1 (CONTROL-GRID) VOLTAGE:</b>		
Positive bias value.....	0 max	volts
PLATE DISSIPATION.....	2 max	watts

<b>GRID-NO.2 INPUT:</b>		
For grid-No.2 voltages up to 150 volts .....	0.5 max	watt
For grid-No.2 voltages between 150 and 300 volts .....	See curve	page 67
<b>PEAK HEATER-CATHODE VOLTAGE:</b>		
Heater negative with respect to cathode .....	200 max	volts
Heater positive with respect to cathode .....	200°max	volts

**Characteristics:**

Plate Supply Voltage .....	200	volts
Grid No.3 .....	Connected to cathode at socket	
Grid-No.2 Supply Voltage .....	150	volts
Cathode-Bias Resistor .....	180	ohms
Plate Resistance (Approx.) .....	0.5	megohm
Transconductance .....	5500	umhos
Grid-No.1 Voltage (Approx.) for transconductance of 50 umhos .....	-12.5	volts
Plate Current .....	9	ma
Grid-No.2 Current .....	3	ma

**Maximum Circuit Values (For maximum rated conditions):**

Grid-No.1-Circuit Resistance:		
For fixed-bias operation .....	0.25 max	megohm
For cathode-bias operation .....	1.0 max	megohm

°The dc component must not exceed 100 volts.

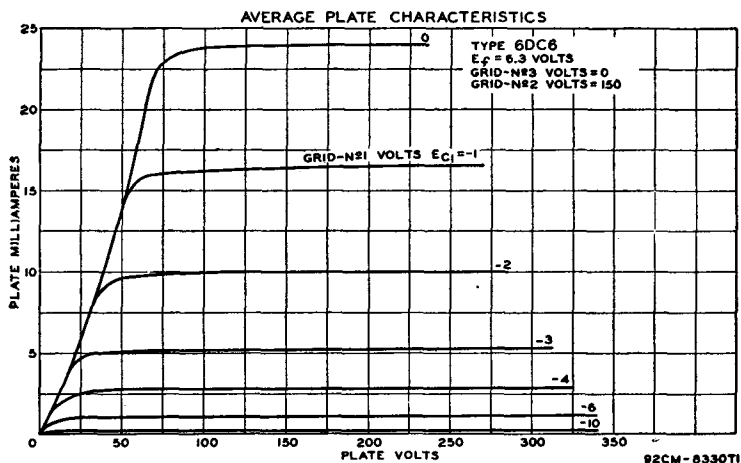

## SHARP-CUTOFF PENTODE

# 6DE6

Miniature type used in the gain-controlled picture if stages of television receivers utilizing an intermediate frequency in the order of 40 megacycles per second. Also used as an rf amplifier

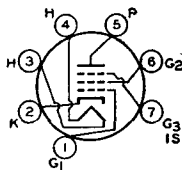

in vhf television tuners. This tube features very high transconductance combined with low interelectrode capacitance values, and is provided with separate base pins for grid No.3 and cathode to permit the use of an unbypassed cathode resistor to minimize the effects of regeneration. Outline 11, **OUTLINES SECTION**. Tube requires miniature seven-contact socket and may be mounted in any position.

<b>HEATER VOLTAGE (AC/DC) .....</b>	6.3	volts
<b>HEATER CURRENT .....</b>	0.3	ampere
<b>DIRECT INTERELECTRODE CAPACITANCES:</b>		
Grid No.1 to Plate .....	0.02 max	μf
Grid No.1 to Cathode, Heater, Grid No.2, Grid No.3, and Internal Shield .....	6.3 max	μf
Plate to Cathode, Heater, Grid No.2, Grid No.3, and Internal Shield .....	1.9 max	μf

## CLASS A<sub>1</sub> AMPLIFIER

### Maximum Ratings:

PLATE VOLTAGE.....	300 max	volts
GRID-NO.3 (SUPPRESSOR-GRID) VOLTAGE.....	0 max	volts
GRID-NO.2 (SCREEN-GRID) SUPPLY VOLTAGE.....	300 max	volts
GRID-NO.2 VOLTAGE.....	See curve page 67	
GRID-NO.1 (CONTROL-GRID) VOLTAGE:		
Positive bias value.....	0 max	volts
PLATE DISSIPATION.....	2 max	watts
GRID-NO.2 INPUT:		
For grid-No.2 voltages up to 150 volts.....	0.5 max	watt
For grid-No.2 voltages between 150 and 300 volts.....	See curve page 67	
PEAK HEATER-CATHODE VOLTAGE:		
Heater negative with respect to cathode.....	200 max	volts
Heater positive with respect to cathode.....	200 max	volts

### Characteristics:

Plate Supply Voltage.....	200	volts
Grid No.3.....	Connected to cathode at socket	
Grid-No.2 Supply Voltage.....	150	volts
Cathode-Bias Resistor.....	180	ohms
Plate Resistance (Approx.).....	0.6	megohm
Transconductance.....	6200	$\mu$ mhos
Grid-No.1 Voltage (Approx.) for transconductance of 600 $\mu$ mhos with plate voltage of 150 volts and no cathode resistor.....	-5.5	volts
Grid-No.1 Voltage (Approx.) for plate current of 10 $\mu$ a.....	-10	volts
Plate Current.....	9.5	ma
Grid-No.2 Current.....	2.8	ma

### AVERAGE PLATE CHARACTERISTICS

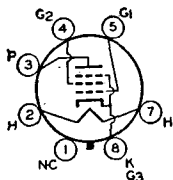
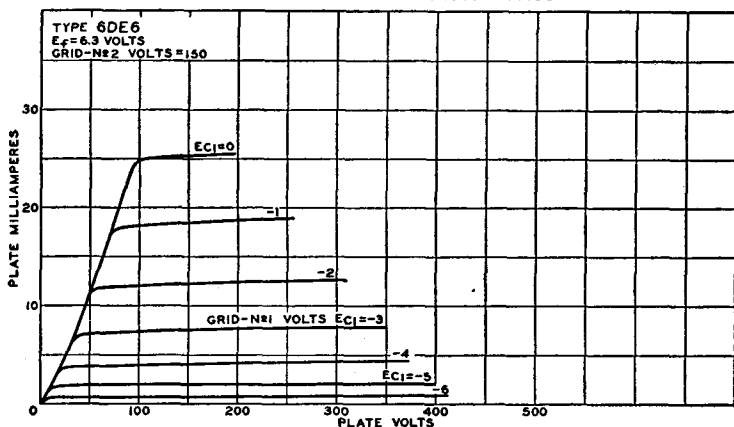

### BEAM POWER TUBE

Glass octal type used as output tube in audio-amplifier applications. Outline 22 or 23, OUTLINES SECTION. Tube requires octal socket and may be mounted in any position.

# 6DG6-GT

HEATER VOLTAGE (AC/DC).....	6.3	volts
HEATER CURRENT.....	1.2	amperes
DIRECT INTERELECTRODE CAPACITANCES (Approx.):		
Grid No.1 to Plate.....	0.6	$\mu$ f
Grid No.1 to Cathode, Heater, Grid No.2, and Grid No.3.....	15	$\mu$ f
Plate to Cathode, Heater, Grid No.2, and Grid No.3.....	10	$\mu$ f

## CLASS A<sub>1</sub> AMPLIFIER

### Maximum Ratings:

PLATE VOLTAGE.....	200 max	volts
GRID-NO.2 (SCREEN-GRID) VOLTAGE.....	125 max	volts
PLATE DISSIPATION.....	10 max	watts
GRID-NO.2 INPUT.....	1.25 max	watts
PEAK HEATER-CATHODE VOLTAGE:		
Heater negative with respect to cathode.....	90 max	volts
Heater positive with respect to cathode.....	90 max	volts

### Typical Operation:

Plate Supply Voltage.....	110	200	volts
Grid-No.2 Supply Voltage.....	110	125	volts
Grid-No.1 (Control-Grid) Voltage.....	-7.5	0	volts
Peak AF Grid-No.1 Voltage.....	7.5	8.5	volts
Cathode-Bias Resistor.....	0	180	ohms
Zero-Signal Plate Current.....	49	46	ma
Maximum-Signal Plate Current.....	50	47	ma
Zero-Signal Grid-No.2 Current.....	4	2.2	ma
Maximum-Signal Grid-No.2 Current.....	10	8.5	ma
Plate Resistance (Approx.).....	13000	28000	ohms
Transconductance.....	8000	8000	μmhos
Load Resistance.....	2000	4000	ohms
Total Harmonic Distortion.....	10	10	per cent
Maximum-Signal Power Output.....	2.1	3.8	watts

### Maximum Circuit Values:

Grid-No.1-Circuit Resistance:		
For fixed-bias operation.....	0.1 max	megohm
For cathode-bias operation.....	0.5 max	megohm

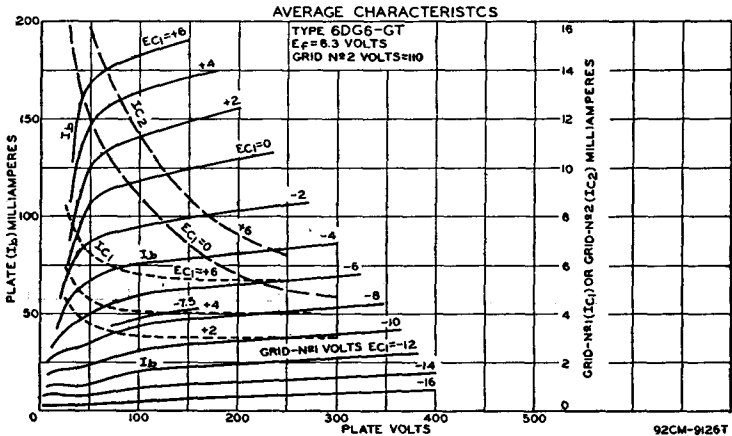

## BEAM POWER TUBE

Glass octal type used as horizontal deflection amplifier in high-efficiency deflection circuit of television receivers. Outline 37, OUTLINES SECTION. Tube requires octal socket and may be mounted in any position.

## 6DQ6-A

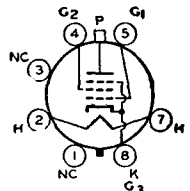

HEATER VOLTAGE (AC/DC).....	6.3	volts
HEATER CURRENT.....	1.2	amperes
DIRECT INTERELECTRODE CAPACITANCES (Approx.):		
Grid No.1 to Plate.....	0.55	μμf
Grid No.1 to Cathode, Heater, Grid No.2, and Grid No.3.....	15	μμf
Plate to Cathode, Heater, Grid No.2, and Grid No.3.....	7	μμf
TRANSCONDUCTANCE*.....	6600	μmhos
PLATE RESISTANCE*.....	20000	ohms
MU-FACTOR, Grid No.2 to Grid No.1**.....	4.1	

\* For plate volts, 250; grid-No.2 volts, 150; grid-No.1 volts, -22.5; plate ma., 75; grid-No.2 ma., 2.4.

\*\* For plate and grid-No.2 volts, 150; grid-No.1 volts, -22.5.

# RCA Receiving Tube Manual

## HORIZONTAL DEFLECTION AMPLIFIER

For operation in a 525-line, 30-frame system

### Maximum Ratings:

DC PLATE VOLTAGE.....	700 max	volts
PEAK POSITIVE-PULSE PLATE VOLTAGE (Absolute Maximum) #.....	6000 <sup>□</sup> max	volts
PEAK NEGATIVE-PULSE PLATE VOLTAGE.....	-1375 max	volts
DC GRID-NO.2 (SCREEN-GRID) VOLTAGE.....	200 max	volts
DC GRID-NO.1 (CONTROL-GRID) VOLTAGE.....	-50 max	volts
PEAK NEGATIVE-PULSE GRID-NO.1 VOLTAGE.....	-300 max	volts
<b>CATHODE CURRENT:</b>		
Peak.....	440 max	ma
Average.....	140 max	ma
GRID-NO.2 INPUT.....	3 max	watts
PLATE DISSIPATION†.....	15 max	watts
<b>PEAK HEATER-CATHODE VOLTAGE:</b>		
Heater negative with respect to cathode.....	200 max	volts
Heater positive with respect to cathode.....	200 <sup>*</sup> max	volts
BULB TEMPERATURE (At hottest point).....	220 max	°C

### Maximum Circuit Values:

Grid-No.1-Circuit Resistance: ..... 1.0 max megohm

# The duration of the voltage pulse must not exceed 15 per cent of one horizontal scanning cycle. In a 525-line, 30-frame system, 15 per cent of one horizontal scanning cycle is 10 microseconds.

□ Under no circumstances should this absolute value be exceeded.

† An adequate bias resistor or other means is required to protect the tube in the absence of excitation.

\* The dc component must not exceed 100 volts.

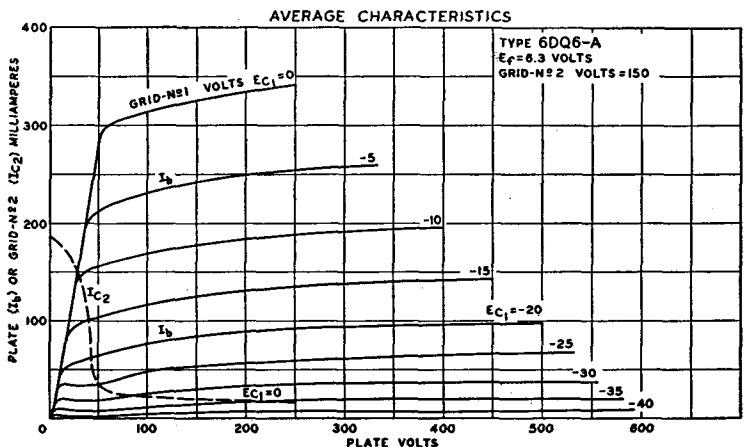

92CM-8953T

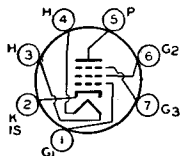

### SHARP-CUTOFF PENTODE

Miniature type used as FM detector in television receivers. Outline 11, OUTLINES SECTION. Tube requires miniature seven-contact socket and may be mounted in any position.

# 6DT6

HEATER VOLTAGE (AC/DC).....	6.3	volts
HEATER CURRENT.....	0.3	ampere
<b>DIRECT INTERELECTRODE CAPACITANCES (Approx.)*</b>		
Grid No.1 to Plate.....	0.02	μf
Grid No.1 to Cathode, Heater, Grid No.2, Grid No.3, and Internal Shield.....	5.8	μf
Grid No.3 to Plate.....	1.4	μf
Grid No.1 to Grid No.3.....	0.1	μf
Grid No.3 to Cathode, Heater, Grid No.2, Grid No.3, and Internal Shield.....	6.1	μf

\*External shield connected to cathode.

## CLASS A<sub>1</sub> AMPLIFIER

### Characteristics:

Plate Supply Voltage	150	volts
Grid-No.3 (Suppressor-Grid) Supply Voltage	0	volts
Grid-No.2 (Screen-Grid) Supply Voltage	100	volts
Cathode-Bias Resistor	560	ohms
Plate Resistance (Approx.)	0.15	megohm
Transconductance, Grid No.1 to Plate	800	$\mu$ mhos
Transconductance, Grid No.3 to Plate	515	$\mu$ mhos
Plate Current	1.1	ma
Grid-No.2 Current	2.1	ma
Grid-No.1 Voltage (Approx.) for plate current of 10 $\mu$ a	-4.5	volts
Grid-No.3 Voltage (Approx.) for plate current of 10 $\mu$ a	-3.5	volts

### FM DETECTOR SERVICE

#### Maximum Ratings:

PLATE VOLTAGE	300 max	volts
GRID-NO.3 VOLTAGE	25 max	volts
GRID-NO.2 SUPPLY VOLTAGE	300 max	volts
GRID-NO.2 VOLTAGE	See curve page 67	
GRID-NO.1 (CONTROL-GRID) VOLTAGE:		
Positive bias value	0 max	volts
GRID-NO.2 INPUT:		
For grid-No.2 voltages up to 150 volts	1.5 max	watts
For grid-No.2 voltages between 150 and 300 volts	See curve page 67	

#### AVERAGE CHARACTERISTICS

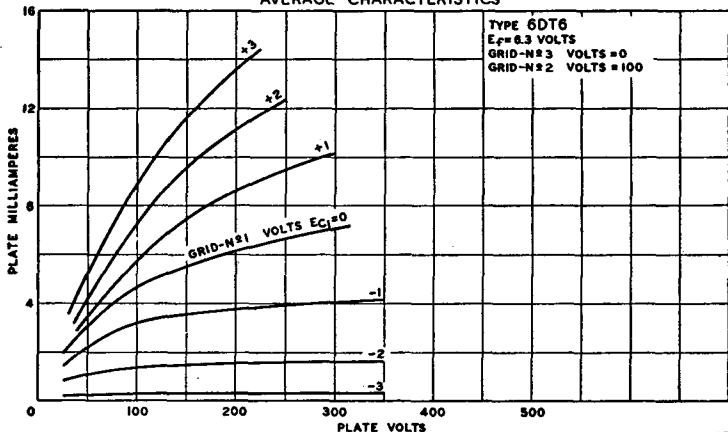

92CM-8827T

#### AVERAGE CHARACTERISTICS

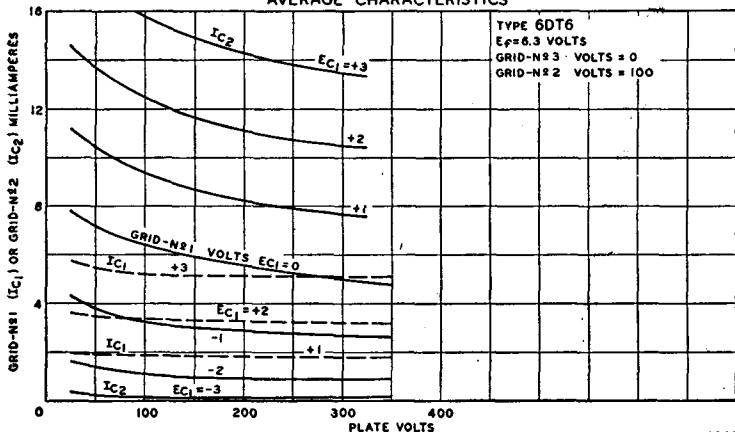

92CM-8829T

**PEAK HEATER-CATHODE VOLTAGE:**

Heater negative with respect to cathode.....	200 max	volts
Heater positive with respect to cathode.....	200 <sup>max</sup>	volts

**Maximum Circuit Values:**

<b>Grid-No.1-Circuit Resistance:</b>		
For fixed-bias operation.....	0.25 max	megohm
For cathode-bias operation.....	0.5 max	megohm

■ The dc component must not exceed 100 volts.

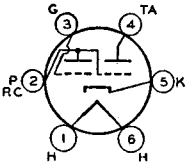

**ELECTRON-RAY TUBE**

Glass type used to indicate visually by means of a fluorescent target the effects of a change in a controlling voltage. It is used as a convenient means of indicating accurate radio-

**6E5**

receiver tuning. Outline 34, OUTLINES SECTION. Tube requires six-contact socket. Heater volts (ac/dc), 6.3; amperes, 0.3. For additional considerations, refer to *Tuning Indication with Electron-Ray Tubes* in ELECTRON TUBE APPLICATIONS SECTION.

**Maximum Ratings:**

<b>PLATE-SUPPLY VOLTAGE</b> .....	250 max	volts
<b>TARGET VOLTAGE</b> .....	{ 250 max	volts
	{ 125 min	volts

**Typical Operation:**

Plate and Target Supply.....	200	250	volts
Series Triode-Plate Resistor.....	1	1	megohm
Target Current*†.....	3	4	ma
Triode-Plate Current*.....	0.19	0.24	ma
<b>Triode-Grid Voltage (Approx.):</b>			
For shadow angle of 0°.....	-6.5	-8.0	volts
For shadow angle of 90°.....	0	0	volts

\* For zero triode-grid voltage. † Subject to wide variations.

**TUNING INDICATOR**

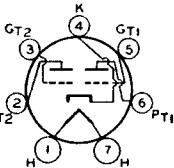

**TWIN POWER TRIODE**

Glass type used as class A<sub>1</sub> amplifier in either push-pull or parallel circuits. Outline 42, OUTLINES SECTION. Heater volts (ac/dc), 6.3; amperes, 0.6. With plate volts of 250 and grid volts of -27.5, characteristics for each unit are: plate ma., 18; plate resistance, 3500 ohms; transconductance, 1700 μmhos; amplification factor, 6. With plate-to-plate load resistance

**6E6**

of 14000 ohms, output for two tubes is 1.6 watts. This is a DISCONTINUED type listed for reference only.

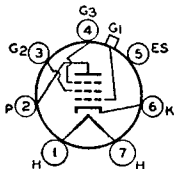

**REMOTE-CUTOFF PENTODE**

Glass type used in rf and if stages of radio receiver employing avc. Outline 44, OUTLINES SECTION. Except for interelectrode capacitances, this type is identical electrically with type 6U7-G. Heater volts (ac/dc), 6.3; amperes, 0.3. This is a DISCONTINUED type listed for reference only.

**6E7**

**HIGH-MU TRIODE**

Metal type 6F5 and glass-octal type 6F5-GT used in resistance-coupled amplifier circuits. Outlines 4 and 21, respectively, OUTLINES SECTION. Tubes require octal socket and may be mounted in any position. Type 6F5-GT may be supplied with pin No.1 omitted. For typical operation as a resistance-coupled amplifier, refer to Chart 17, RESISTANCE-COUPLED AMPLIFIER SECTION. For

**6F5**  
**6F5-GT**

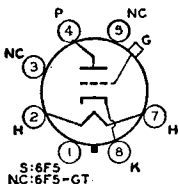

heater and cathode considerations, refer to type 6AV6. Heater volts (ac/dc), 6.3; amperes, 0.3. Typical operation as class A<sub>1</sub> amplifier: plate volts, 250 (300 max); grid volts, -2; amplification factor, 100; plate resistance, 66000 ohms; transconductance, 1500  $\mu$ mhos; plate ma., 0.9. These types are used principally for renewal purposes.

## 6F6 6F6-G 6F6-GT

### POWER PENTODE

Metal type 6F6 and glass-octal types 6F6-G and 6F6-GT are used in the audio output stage of ac receivers. They are capable of large power output with relatively small input voltage.

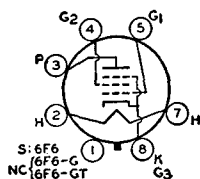

Outlines 6, 41, and 27, respectively, OUTLINES SECTION. Type 6F6-GT may be supplied with pin No.1 omitted. Tubes require octal socket and may be mounted in any position. It is especially important that these tubes, like other power-handling tubes, be adequately ventilated. Types 6F6-G and 6F6-GT are used principally for renewal purposes.

HEATER VOLTAGE (AC/DC) .....	6.3	volts
HEATER CURRENT .....	0.7	ampere

#### SINGLE-TUBE CLASS A<sub>1</sub> AMPLIFIER

**Maximum Ratings:**

PLATE VOLTAGE .....	375 max	volts
GRID No.2 (SCREEN-GRID) VOLTAGE .....	285 max	volts
PLATE DISSIPATION .....	11 max	watts
GRID-No.2 INPUT .....	3.75 max	watts
<b>PEAK HEATER-CATHODE VOLTAGE:</b>		
Heater negative with respect to cathode .....	90 max	volts
Heater positive with respect to cathode .....	90 max	volts

**Typical Operation:**

	Fixed Bias		Cathode Bias		
Plate Supply Voltage .....	250	285	250	285	volts
Grid-No.2 Supply Voltage .....	250	285	250	285	volts
Grid-No.1 (Control-Grid) Voltage .....	-16.5	-20	-	-	volts
Cathode-Bias Resistor .....	-	-	410	440	ohms
Peak AF Grid-No.1 Voltage .....	16.5	20	16.5	20	volts
Zero-Signal Plate Current .....	34	38	34	38	ma
Maximum-Signal Plate Current .....	36	40	35	38	ma
Zero-Signal Grid-No.2 Current .....	6.5	7	6.5	7	ma
Maximum-Signal Grid-No.2 Current .....	10.5	13	9.7	12	ma
Plate Resistance (Approx.) .....	80000	78000	-	-	ohms
Transconductance .....	2500	2650	-	-	$\mu$ mhos
Load Resistance .....	7000	7000	7000	7000	ohms
Total Harmonic Distortion .....	8	9	8.5	9	per cent
Maximum-Signal Power Output .....	3.2	4.8	3.1	4.5	watts

**Maximum Ratings:**

#### PUSH-PULL CLASS A<sub>1</sub> AMPLIFIER

(Same as for single-tube class A<sub>1</sub> amplifier)

**Typical Operation (Values are for two tubes):**

	Fixed Bias	Cathode Bias	
Plate Supply Voltage .....	315	315	volts
Grid-No.2 Supply Voltage .....	285	285	volts
Grid-No.1 (Control-Grid) Voltage .....	-24	-	volts
Cathode-Bias Resistor .....	-	320	ohms
Peak AF Grid-No.1-to-Grid-No.1 Voltage .....	48	58	volts
Zero-Signal Plate Current .....	62	62	ma
Maximum-Signal Plate Current .....	80	78	ma
Zero-Signal Grid-No.2 Current .....	12	12	ma
Maximum-Signal Grid-No.2 Current .....	19.5	18	ma
Effective Load Resistance (Plate-to-plate) .....	10000	10000	ohms
Total Harmonic Distortion .....	4	3	per cent
Maximum-Signal Power Output .....	11	10.5	watts



**MEDIUM-MU TRIODE—  
REMOTE-CUTOFF PENTODE**

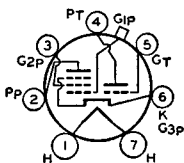

**6F7**

Glass type adaptable to circuit design in several ways. Except for common cathode, the triode and pentode units are independent of each other. Outline 39, OUTLINES SECTION. Heater volts (ac/dc), 6.3; amperes, 0.3. Typical operation of pentode unit as class A<sub>1</sub> amplifier: plate volts, 250 *max*; grid-No.2 volts, 100; grid-No.1 volts, -3; plate resistance, 0.85 megohm; transconductance, 1100  $\mu$ mhos; plate ma.,

6.5; grid-No. 2 ma., 1.5. Typical operation of triode unit as class A amplifier: plate volts, 100 *max*; grid volts, -3; amplification factor, 8; plate resistance, 0.016 megohm; transconductance, 500  $\mu$ mhos; plate ma., 3.5. This type is used principally for renewal purposes.

**MEDIUM-MU TWIN TRIODE**

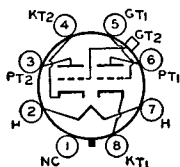

**6F8-G**

Glass octal type used as voltage amplifier or phase inverter in radio equipment. Except for common heater each triode is independent of the other. Outline 38, OUTLINES SECTION. Tube requires octal socket. Except for the heater rating of 6.3 volts (ac/dc) and 0.6 ampere and interelectrode capacitances, each triode unit is identical electrically with type 6J5. For typical operation as a resistance-coupled amplifier, refer to Chart 13, RESISTANCE-COUPLED AMPLIFIER SECTION. Type 6F8-G is used principally for renewal purposes.

**POWER PENTODE**

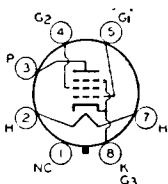

**6G6-G**

Glass octal type used in output stage of radio receivers where moderate power output is required. This type is economical because of its low plate-power requirements and low heater current. Outline 36, OUTLINES SECTION. Tube requires octal socket. Except for interelectrode capacitances and a plate resistance of 175000 ohms, this type is electrically identical with type 6AK6. Heater volts (ac/dc), 6.3; amperes, 0.15. This type is used principally for renewal purposes.

**TWIN DIODE**

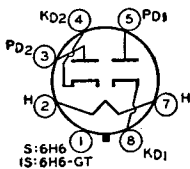

**6H6  
6H6-GT**

Metal type 6H6 and glass-octal type 6H6-GT are used as detectors, low-voltage rectifiers, and avc tubes. Except for the common heater, the two diode units are independent of

each other. For diode detector considerations, refer to ELECTRON TUBE APPLICATIONS SECTION. Type 6H6-GT is a DISCONTINUED type listed for reference only.

HEATER VOLTAGE (AC/DC).....	6.3	volts
HEATER CURRENT.....	0.3	ampere
DIRECT INTERELECTRODE CAPACITANCES:†		
	<b>6H6</b>	<b>6H6-GT</b>
Plate No.1 to Cathode No.1.....	3.0	3.0
Plate No.2 to Cathode No.2.....	3.4	4.0
Plate No.1 to Plate No.2.....	0.1 <i>max</i>	0.1 <i>max</i>
		$\mu$ f
		$\mu$ f
		$\mu$ f

† With shell or external and internal shields connected to cathode.

**Maximum Ratings:**

**RECTIFIER OR DOUBLER**

PEAK INVERSE PLATE VOLTAGE.....	420 <i>max</i>	volts
PEAK PLATE CURRENT (Per Plate).....	48 <i>max</i>	ma
DC OUTPUT CURRENT (Per Plate).....	8 <i>max</i>	ma
PEAK HEATER-CATHODE VOLTAGE:		
Heater negative with respect to cathode.....	330 <i>max</i>	volts
Heater positive with respect to cathode.....	330 <i>max</i>	volts

## Typical Operation (As Half-Wave Rectifier)\*

AC Plate Voltage (Per Plate, rms) .....	117	150	volts
Min. Total Effective Plate-Supply Impedance (Per Plate)* .....	15	40	ohms
DC Output Current (Per Plate) .....	8	8	ma

## Typical Operation (As Voltage Doubler):

	<i>Half-Wave</i>	<i>Full-Wave</i>	
AC Plate Voltage (Per Plate, rms) .....	117	117	volts
Min. Total Effective Plate-Supply Impedance (Per Plate) <sup>o</sup> .....	30	15	ohms
DC Output Current .....	8	8	ma

\* In half-wave service, the two units may be used separately or in parallel.

<sup>o</sup> When a filter-input capacitor larger than 40  $\mu$ f is used, it may be necessary to use more plate-supply impedance than the value shown to limit the peak plate current to the rated value.

## INSTALLATION AND APPLICATION

Types 6H6 and 6H6-GT require an octal socket and may be mounted in any position. Type 6H6-GT may be supplied with pin No.1 omitted. Outlines 1 and 23 respectively, OUTLINES SECTION. For heater and cathode considerations, refer to type 6AV6.

For detection, the diodes may be utilized in a full-wave circuit or in a half-wave circuit. In the latter case, one plate only, or the two plates in parallel, may be employed. For the same signal voltage, the use of the half-wave arrangement will provide approximately twice the rectified voltage as compared with the full-wave arrangement.

For automatic-volume control, the 6H6 and 6H6-GT may be used in circuits similar to those employed for any of the twin-diode types of tubes. The only difference is that the 6H6 and 6H6-GT are more adaptable because each diode has its own separate cathode.

## MEDIUM-MU TRIODE

# 6J5 6J5-GT

Metal type 6J5 and glass-octal type 6J5-GT used as detectors, amplifiers, or oscillators in radio equipment. These types feature high transconductance together with comparatively

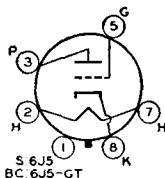

high amplification factor. Outlines 3 and 25, respectively, OUTLINES SECTION. Tubes require octal socket and may be mounted in any position. For heater and cathode considerations, refer to type 6AV6. For typical operation as resistance-coupled amplifiers, refer to Chart 13, RESISTANCE-COUPLED AMPLIFIER SECTION.

HEATER VOLTAGE (AC/DC) .....	6.3	volts	
HEATER CURRENT .....	0.3	ampere	
DIRECT INTERELECTRODE CAPACITANCES (Approx.):	<i>6J5*</i>	<i>6J5-GT**</i>	
Grid to Plate .....	3.4	3.8	$\mu$ f
Grid to Cathode and Heater .....	3.4	4.2	$\mu$ f
Plate to Cathode and Heater .....	3.6	5.0	$\mu$ f

\* Shell connected to cathode.

\*\* Base sleeve and external shield connected to cathode.

### Maximum Ratings:

### CLASS A<sub>1</sub> AMPLIFIER

PLATE VOLTAGE .....	300 maz	volts
GRID VOLTAGE, Positive Bias Value .....	0 maz	volts
PLATE DISSIPATION .....	2.5 maz	watts
PEAK HEATER-CATHODE VOLTAGE:		
Heater negative with respect to cathode .....	90 maz	volts
Heater positive with respect to cathode .....	90 maz	volts
CATHODE CURRENT .....	20 maz	ma

### Characteristics:

Plate Voltage.....	90	250	volts
Grid Voltage.....	0	-8	volts
Amplification Factor.....	20	20	
Plate Resistance.....	6700	7700	ohms
Transconductance.....	3000	2600	$\mu$ mhos
Grid Voltage (Approx.) for plate current of 10 $\mu$ a.....	-7	-18	volts
Plate Current.....	10	9	ma

### Maximum Circuit Value:

Grid-Circuit Resistance.....	1.0 max	megohm
------------------------------	---------	--------

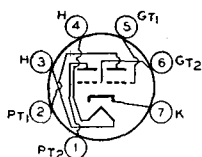
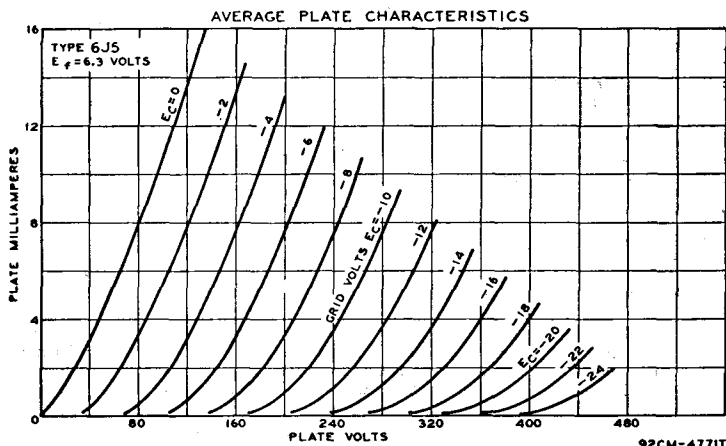

## MEDIUM-MU TWIN TRIODE

Miniature type used as an rf power amplifier and oscillator or as an af amplifier. With a push-pull arrangement of the grids and with the plates in parallel, it is also used as a mixer at

# 6J6

frequencies as high as 600 megacycles per second. Outline 11, **OUTLINES SECTION**. Tube requires miniature seven-contact socket and may be mounted in any position. For heater and cathode considerations, refer to type 6AQ5.

HEATER VOLTAGE (AC/DC).....	6.3	volts
HEATER CURRENT.....	0.45	ampere
DIRECT INTERELECTRODE CAPACITANCES (Each Unit, Approx.):		
Grid to Plate.....	1.6	$\mu$ f
Grid to Cathode and Heater.....	2.2	$\mu$ f
Plate to Cathode and Heater.....	0.4	$\mu$ f

### Maximum Ratings:

### CLASS A<sub>1</sub> AMPLIFIER

PLATE VOLTAGE.....	300 max	volts
PLATE DISSIPATION (Per Unit).....	1.5 max	watts
PEAK HEATER-CATHODE VOLTAGE:		
Heater negative with respect to cathode.....	100 max	volts
Heater positive with respect to cathode.....	100 max	volts

### Characteristics (Each Unit):

Plate Voltage.....	100	volts
Cathode-Bias Resistor.....	50 $\dagger$	ohms

Amplification Factor.....	38	
Plate Resistance.....	7100	ohms
Transconductance.....	5300	$\mu\text{mhos}$
Plate Current.....	8.5	ma

**Maximum Circuit Values** (For maximum rated conditions):

Grid-Circuit Resistance:	
For fixed-bias operation.....	Not recommended
For cathode-bias operation.....	0.5 max megohms

‡ Value is for both units operating at the specified conditions.

## RF POWER AMPLIFIER AND OSCILLATOR—Class C Telegraphy

*Values are for both units, unless otherwise specified.*

**Maximum Ratings:**

DC PLATE VOLTAGE.....	300 max	volts
DC GRID VOLTAGE.....	-40 max	volts
DC PLATE CURRENT (Per Unit).....	15 max	ma
DC GRID CURRENT (Per Unit).....	8 max	ma
DC PLATE INPUT (Per Unit).....	4.5 max	watts
PLATE DISSIPATION (Per Unit).....	1.5 max	watts
PEAK HEATER-CATHODE VOLTAGE:		
Heater negative with respect to cathode.....	100 max	volts
Heater positive with respect to cathode.....	100 max	volts

**Typical Operation:‡**

DC Plate Voltage.....	150	volts
DC Grid Voltage <sup>o</sup> .....	-10	volts
DC Plate Current.....	30	ma
DC Grid Current (Approx.).....	16	ma
Driving Power (Approx.).....	0.35	watt
Power Output (Approx.).....	3.5	watts

‡ At moderate frequencies in push-pull. Key-down conditions without modulation. At 250 Mc, approximately 1.0 watt can be obtained when the 6J6 is used as a push-pull oscillator with a plate voltage of 150 volts, with maximum rated plate dissipation, and with a grid resistor of 2000 ohms common to both units.

<sup>o</sup> Obtained by grid resistor (625 ohms), cathode-bias resistor (220 ohms), or fixed supply.

**AVERAGE PLATE CHARACTERISTICS  
FOR EACH UNIT**

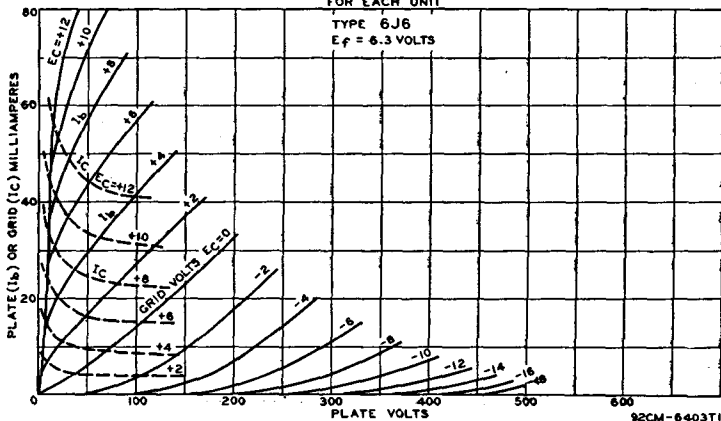

92CM-6403T1

**6J7**  
**6J7-G**  
**6J7-GT**

### SHARP-CUTOFF PENTODE

Metal type 6J7 and glass-octal types 6J7-G and 6J7-GT are used as biased detectors or high-gain audio amplifiers in radio receivers. Outlines 4, 38, and 24, respectively, OUTLINES

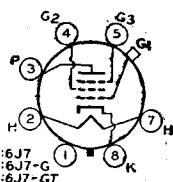

**SECTION.** Type 6J7-GT is used principally for renewal purposes. Type 6J7-G is a **DISCONTINUED** type listed for reference only. All types require octal socket and may be mounted in any position. For typical operation as resistance-coupled amplifiers, refer to Charts 11 and 14, **RESISTANCE-COUPLED AMPLIFIER SECTION.** For heater and cathode considerations, refer to type 6AV6.

HEATER VOLTAGE (AC/DC).....	6.3	volts
HEATER CURRENT.....	0.3	ampere

**Maximum Ratings: CLASS A<sub>1</sub> AMPLIFIER (Pentode Connection)**

PLATE VOLTAGE.....	300 <i>max</i>	volts
GRID-NO.2 (SCREEN-GRID) VOLTAGE.....	See curve page 67	
GRID-NO.2 SUPPLY VOLTAGE.....	300 <i>max</i>	volts
GRID-NO.1 (CONTROL-GRID) VOLTAGE, Positive Bias Value.....	0 <i>max</i>	volts
PLATE DISSIPATION.....	0.75 <i>max</i>	watt
GRID-NO.2 INPUT:		
For grid-No.2 voltages up to 150 volts.....	0.10 <i>max</i>	watt
For grid-No.2 voltages between 150 and 300 volts.....	See curve page 67	
<b>PEAK HEATER-CATHODE VOLTAGE:</b>		
Heater negative with respect to cathode.....	90 <i>max</i>	volts
Heater positive with respect to cathode.....	90 <i>max</i>	volts

**Characteristics:**

Plate Voltage.....	100	250	volts
Grid No.3 (Suppressor-Grid).....	Connected to cathode at socket		
Grid-No.2 Voltage.....	100	100	volts
Grid-No.1 Voltage.....	-3	-3	volts
Plate Resistance.....	1.0	*	megohm
Transconductance.....	1385	1225	μmhos
Grid-No.1 Voltage (Approx.) for cathode-current cutoff.....	-7	-7	volts
Plate Current.....	2	2	ma
Grid-No.2 Current.....	0.5	0.5	ma

**Maximum Circuit Value:**

Grid-No.1-Circuit Resistance.....	1.0 <i>max</i>	megohm
-----------------------------------	----------------	--------

**Maximum Ratings: CLASS A<sub>1</sub> AMPLIFIER (Triode Connection)<sup>o</sup>**

PLATE VOLTAGE.....	250 <i>max</i>	volts
GRID-NO.1 VOLTAGE, Positive Bias Value.....	0 <i>max</i>	volts
PLATE AND GRID-NO.2 DISSIPATION (TOTAL).....	1.75 <i>max</i>	watts

**Characteristics:**

Plate Voltage.....	180	250	volts
Grid-No.1 Voltage.....	-5.3	-8	volts
Amplification Factor.....	20	20	
Plate Resistance.....	11000	10500	ohms
Transconductance.....	1800	1900	μmhos
Plate Current.....	5.3	6.5	ma

**Maximum Circuit Value:**

Grid-No.1-Circuit Resistance.....	1.0 <i>max</i>	megohm
-----------------------------------	----------------	--------

<sup>o</sup> Greater than 1.0 megohm.

\* Grids No.2 and No.3 connected to plate.

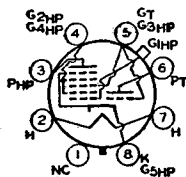

### TRIODE—HEPTODE CONVERTER

Glass octal type used as a combined triode oscillator and heptode mixer in radio receivers. Outline 38, **OUTLINES SECTION.** Tube requires octal socket. Heater volts (ac/dc), 6.3; amperes, 0.3. Typical operation—Heptode unit: plate volts, 250 (300 *max*); grids-No.2-and-No.4 volts, 100 *max*; grid-No.1 volts, -3; plate resistance, 1.5 megohms; conversion transconductance, 290 μmhos; plate ma., 1.4; grids-No.2-and-No.4 ma., 2.8. Triode unit: plate volts, 250 *max* (applied through 20000-ohm dropping resistor); grid resistor, 50000 ohms; plate ma., 5.0. This is a **DISCONTINUED** type listed for reference only.

## 6J8-G

**DISCONTINUED** type listed for reference only.

**HIGH-MU TRIODE**

Glass octal type used as voltage amplifier in radio equipment. Outline 24, OUTLINES SECTION. Tube requires octal socket. Heater volts (ac/dc), 6.3; amperes, 0.3. Characteristics as class A<sub>1</sub> amplifier: plate volts, 250 *max*; grid volts, -3; amplification factor, 70; plate resistance, 50000 ohms; transconductance, 1400  $\mu$ mhos; plate ma., 1.1. This is a DISCONTINUED type listed for reference only.

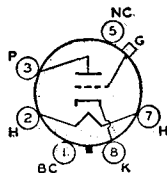

**POWER PENTODE**

Glass octal type used in output stage of radio receivers and, triode-connected, as a vertical deflection amplifier in television receivers. It is capable of delivering moderate power output

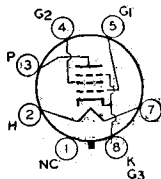

**6K6-GT**

**6K5-GT**

with relatively small input voltage. Tube may be used singly or in push-pull. This type may be supplied with pin No.1 omitted. Tube requires octal socket and may be mounted in any position. Outline 23, OUTLINES SECTION. It is especially important that this tube, like other power-handling tubes, be adequately ventilated.

HEATER VOLTAGE (AC/DC) .....	6.3	volts
HEATER CURRENT .....	0.4	ampere
DIRECT INTERELECTRODE CAPACITANCES (Approx.):		
Grid No.1 to Plate .....	0.5	$\mu$ f.
Grid No.1 to Cathode, Heater, Grid No.2, and Grid No.3 .....	5.5	$\mu$ f.
Plate to Cathode, Heater, Grid No.2, and Grid No.3 .....	6.0	$\mu$ f.

**Maximum Ratings:**

**CLASS A<sub>1</sub> AMPLIFIER**

PLATE VOLTAGE .....	315 <i>max</i>	volts
GRID-NO.2 (SCREEN-GRID) VOLTAGE .....	285 <i>max</i>	volts
PLATE DISSIPATION .....	8.5 <i>max</i>	watts
GRID-NO.2 INPUT .....	2.8 <i>max</i>	watts
GRID-NO.1 (CONTROL-GRID) VOLTAGE, Positive Bias Value .....	0 <i>max</i>	volts
PEAK HEATER-CATHODE VOLTAGE:		
Heater negative with respect to cathode .....	200 <i>max</i>	volts
Heater positive with respect to cathode .....	200* <i>max</i>	volts

\* The dc component must not exceed 100 volts.

**Typical Operation:**

Plate Voltage .....	100	250	315	volts
Grid-No.2 Voltage .....	100	250	250	volts
Grid-No.1 Voltage .....	-7	-18	-21	volts
Peak AF Grid-No.1 Voltage .....	7	18	21	volts
Zero-Signal Plate Current .....	9	32	25.5	ma
Maximum-Signal Plate Current .....	9.5	33	28	ma
Zero-Signal Grid-No.2 Current .....	1.6	5.5	4.0	ma
Maximum-Signal Grid-No.2 Current .....	3	10	9	ma
Plate Resistance (Approx.) .....	104000	90000	110000	ohms
Transconductance .....	1500	2300	2100	$\mu$ mhos
Load Resistance .....	12000	7600	9000	ohms
Total Harmonic Distortion .....	11	11	15	per cent
Maximum-Signal Power Output .....	0.35	3.4	4.5	watts

**Typical Push-Pull Operation (Values are for two tubes):**

	<i>Fixed Bias</i>	<i>Cathode Bias</i>	
Plate Supply Voltage .....	285	285	volts
Grid-No.2 Supply Voltage .....	285	285	volts
Grid-No.1 Voltage .....	-25.5	-	volts
Cathode-Bias Resistor .....	-	400	ohms
Peak AF Grid-No.1-to-Grid-No.1 Voltage .....	51	51	volts
Zero-Signal Plate Current .....	55	55	ma
Maximum-Signal Plate Current .....	72	61	ma
Zero-Signal Grid-No.2 Current .....	9	9	ma
Maximum-Signal Grid-No.2 Current .....	17	13	ma
Effective Load Resistance (Plate-to-plate) .....	12000	12000	ohms
Total Harmonic Distortion .....	6	4	per cent
Maximum-Signal Power Output .....	10.5	9.8	watts

### Maximum Circuit Values:

Grid-No.1-Circuit Resistance:		
For fixed-bias operation.....	0.1 max	megohm
For cathode-bias operation.....	0.5 max	megohm

### Characteristics (Triode Connection)\*:

Plate Voltage.....	250	volts
Grid-No.1 Voltage.....	-18	volts
Plate Current.....	37.5	ma
Transconductance.....	2700	$\mu$ mhos
Amplification Factor.....	6.8	
Plate Resistance (Approx.).....	2500	ohms
Grid Voltage (Approx.) for plate current of 0.5 ma.....	-48	volts

\* Grid-No.2 connected to plate.

### VERTICAL DEFLECTION AMPLIFIER (Triode Connection)\*

*For operation in a 525-line, 30-frame system*

<b>Maximum Ratings:</b>		
DC PLATE VOLTAGE.....	315 max	volts
PEAK POSITIVE-PULSE PLATE VOLTAGE† (Absolute maximum).....	1200 <sup>o</sup> max	volts
PEAK NEGATIVE-PULSE GRID-NO.1 VOLTAGE.....	-250 max	volts
<b>CATHODE CURRENT:</b>		
Peak.....	75 max	ma
Average.....	25 max	ma
<b>PLATE DISSIPATION.....</b>		
	7 max	watts
<b>PEAK HEATER-CATHODE VOLTAGE:</b>		
Heater negative with respect to cathode.....	200 max	volts
Heater positive with respect to cathode.....	200 <sup>o</sup> max	volts

### Maximum Circuit Value:

Grid-No.1-Circuit Resistance:	
For cathode-bias operation.....	2.2 max megohms

\* Grid No.2 connected to plate.

† The duration of the voltage pulse must not exceed 15 per cent of one vertical scanning cycle. In a 525-line, 30-frame system, 15 per cent of one vertical scanning cycle is 2.5 milliseconds.

<sup>o</sup> Under no circumstances should this absolute value be exceeded.

■ The dc component must not exceed 100 volts.

AVERAGE PLATE CHARACTERISTICS  
PENTODE CONNECTION

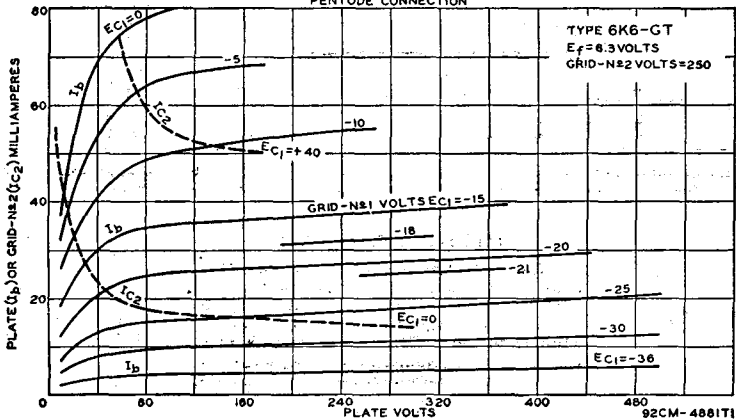

### REMOTE-CUTOFF PENTODE

Metal type 6K7 and glass-octal types 6K7-G and 6K7-GT used in rf and if stages of radio receivers, particularly in those employing avc. Outlines 4, 38, and 24, respectively, OUTLINES SECTION. These tubes require octal socket and may be mounted in any position. For electrode voltage supplies and application, refer to type 6SK7. For heater and cathode

6K7  
6K7-G  
6K7-GT

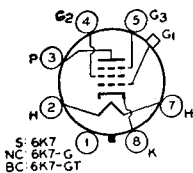

considerations, refer to type 6AV6. Heater volts (ac/dc), 6.3; amperes, 0.3. Typical operation and maximum ratings as class A<sub>1</sub> amplifier: plate volts 250 (300 max); grid No.3 connected to cathode at socket; grid-No.2 supply volts, 300 max; grid-No.2 volts, 125; grid-No.1 volts, -3; plate resistance, 0.6 megohm; transconductance, 1650  $\mu$ mhos; plate ma., 10.5; grid-No.2 ma., 2.6; plate dissipation, 2.75 max watts; grid-No.2 input, 0.35 max watts. Types 6K7 and 6K7-GT are used principally for renewal purposes. Type 6K7-G is a DISCONTINUED type listed for reference only.

**6K8**  
**6K8-G**  
**6K8-GT**

**TRIODE-HEXODE CONVERTER**

Metal type 6K8 and glass-octal types 6K8-G and 6K8-GT used as combined triode oscillator and hexode mixer in radio receivers. Type 6K8, Outline 5, type 6K8-G, Outline 38,

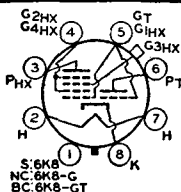

**OUTLINES SECTION.** Types 6K8-G and 6K8-GT are **DISCONTINUED** types listed for reference only. Tubes require octal socket and may be mounted in any position. For heater and cathode considerations, refer to type 6AV6. For application, refer to *Frequency Conversion* in **ELECTRON TUBE APPLICATIONS SECTION.**

HEATER VOLTAGE (AC/DC).....	6.3	volts
HEATER CURRENT.....	0.3	ampere

Maximum Ratings:	CONVERTER SERVICE	
HEXODE PLATE VOLTAGE.....	300 max	volts
HEXODE GRIDS-NO.2-AND-NO.4 (SCREEN-GRID) VOLTAGE.....	150 max	volts
HEXODE GRIDS-NO.2-AND-NO.4 SUPPLY VOLTAGE.....	300 max	volts
HEXODE GRID-NO.3 (CONTROL-GRID) VOLTAGE, Positive Bias Value.....	0 max	volts
TRIODE PLATE VOLTAGE.....	125 max	volts
HEXODE PLATE DISSIPATION.....	0.75 max	watt
HEXODE GRIDS-NO.2-AND-NO.4 INPUT.....	0.7 max	watt
TRIODE PLATE DISSIPATION.....	0.75 max	watt
TOTAL CATHODE CURRENT.....	16 max	ma
PEAK HEATER-CATHODE VOLTAGE:		
Heater negative with respect to cathode.....	90 max	volts
Heater positive with respect to cathode.....	90 max	volts

**Typical Operation.**

Hexode Plate Voltage.....	100	250	volts
Hexode Grids-No.2-and-No.4 Voltage.....	100	100	volts
Hexode Grid-No.3 Voltage.....	-3	-3	volts
Triode Plate Voltage.....	100	100	volts
Triode Grid Resistor.....	50000	50000	ohms
Hexode Plate Resistance (Approx.).....	0.4	0.6	megohm
Conversion Transconductance.....	325	350	μmhos
Hexode Grid-No.3 Voltage (Approx.) for conversion transconductance of 2 μmhos.....	-30	-30	volts
Hexode Plate Current.....	2.3	2.5	ma
Hexode Grids-No.2-and-No.4 Current.....	6.2	6.0	ma
Triode Plate Current.....	3.8	3.8	ma
Triode Grid and Hexode Grid-No.1 Current.....	0.15	0.15	ma
Total Cathode Current.....	12.5	12.5	ma

The transconductance of the triode section, not oscillating, of the 6K8 is approximately 3000 μmhos when the triode plate voltage is 100 volts, and the triode grid voltage is 0 volts.

**MEDIUM-MU TRIODE**

Glass octal type used as detector, amplifier, or oscillator in radio receivers. Outline 36, **OUTLINES SECTION.** Heater volts (ac/dc), 6.3; amperes, 0.15. Typical operation and characteristics: plate volts, 250 max; grid volts, -9; plate ma., 8; plate resistance, 9000 ohms; amplification factor, 17; transconductance, 1900 μmhos; grid voltage for cathode-current cutoff, -20. This is a **DISCONTINUED** type listed for reference only.

**6L5-G**

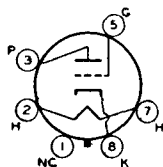

**6L6**  
**6L6-G**

**BEAM POWER TUBE**

Metal type 6L6 and glass-octal type 6L6-G are used in output stage of radio receivers and amplifiers, especially those designed to have ample reserve of power-delivering ability.

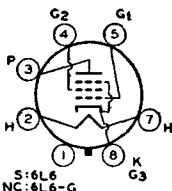

These types provide high power output, sensitivity, and high efficiency. Power output at all levels has low third and negligible higher-order harmonics. For discussion of beam power tube considerations, refer to **ELECTRONS, ELECTRODES, AND ELECTRON TUBES SECTION.**



## RCA Receiving Tube Manual

HEATER VOLTAGE (AC/DC).....	6.3	volts
HEATER CURRENT.....	0.9	ampere
DIRECT INTERELECTRODE CAPACITANCES (Approx.)*:	6L6	6L6-G
Grid No.1 to Plate.....	0.4	0.9
Grid No.1 to Cathode, Heater, Grid No.2, and Grid No.3..	10	11.5
Plate to Cathode, Heater, Grid No.2, and Grid No.3.....	12	9.5

\* Pin No.1 connected to pin No.8.

### Maximum Ratings: SINGLE-TUBE CLASS A<sub>1</sub> AMPLIFIER

PLATE VOLTAGE.....	360 max	volts
GRID-NO.2 (SCREEN-GRID) VOLTAGE.....	270 max	volts
PLATE DISSIPATION.....	19 max	watts
GRID-NO.2 INPUT.....	2.5 max	watts
PEAK HEATER-CATHODE VOLTAGE:		
Heater negative with respect to cathode.....	180 max	volts
Heater positive with respect to cathode.....	180 max	volts

### Typical Operation:

	<i>Fixed Bias</i>		<i>Cathode Bias</i>		
Plate Supply Voltage.....	250	350	250	300	volts
Grid-No.2 Supply Voltage.....	250	250	250	200	volts
Grid-No.1 (Control-Grid) Voltage.....	-14	-18	-	-	volts
Cathode-Bias Resistor.....	-	-	170	220	ohms
Peak AF Grid-No.1 Voltage.....	14	18	14	12.5	volts
Zero-Signal Plate Current.....	72	54	75	51	ma
Maximum-Signal Plate Current.....	79	66	78	54.5	ma
Zero-Signal Grid-No.2 Current.....	5	2.5	5.4	3	ma
Maximum-Signal Grid-No.2 Current.....	7.3	7	7.2	4.6	ma
Plate Resistance.....	22500	33000	-	-	ohms
Transconductance.....	6000	5200	-	-	μmhos
Load Resistance.....	2500	4200	2500	4500	ohms
Total Harmonic Distortion.....	10	15	10	11	per cent
Maximum-Signal Power Output.....	6.5	10.8	6.5	6.5	watts

### SINGLE-TUBE CLASS A<sub>1</sub> AMPLIFIER (Triode Connection)†

#### Maximum Ratings:

PLATE VOLTAGE.....	275 max	volts
PLATE AND GRID-NO.2 DISSIPATION (TOTAL).....	19.0 max	watts
PEAK HEATER-CATHODE VOLTAGE:		
Heater negative with respect to cathode.....	180 max	volts
Heater positive with respect to cathode.....	180 max	volts

#### Typical Operation:

	<i>Fixed Bias</i>		<i>Cathode Bias</i>		
Plate Supply Voltage.....	250		250		volts
Grid-No.1 Voltage.....	-20		-		volts
Cathode-Bias Resistor.....	-		490		ohms
Peak AF Grid-No.1 Voltage.....	20		20		volts
Zero-Signal Plate Current.....	40		40		ma
Maximum-Signal Plate Current.....	44		42		ma
Plate Resistance.....	1700		-		ohms
Amplification Factor.....	8		-		
Transconductance.....	4700		-		μmhos
Load Resistance.....	5000		6000		ohms
Total Harmonic Distortion.....	5		6		per cent
Maximum-Signal Power Output.....	1.4		1.3		watts

† Grid No.2 connected to plate.

### Maximum Ratings: PUSH-PULL CLASS A<sub>1</sub> AMPLIFIER

(Same as for single-tube class A<sub>1</sub> amplifier)

#### Typical Operation (Values are for two tubes):

	<i>Fixed Bias</i>		<i>Cathode Bias</i>		
Plate Supply Voltage.....	250	270	270		volts
Grid-No.2 Supply Voltage.....	250	270	270		volts
Grid-No.1 Voltage.....	-16	-17.5	-		volts
Cathode-Bias Resistor.....	-	-	125		ohms
Peak AF Grid-No.1-to-Grid-No.1 Voltage.....	32	35	28.2		volts
Zero-Signal Plate Current.....	120	134	134		ma
Maximum-Signal Plate Current.....	140	155	145		ma
Zero-Signal Grid-No.2 Current.....	10	11	11		ma
Maximum-Signal Grid-No.2 Current.....	16	17	17		ma

Plate Resistance (Per tube) . . . . .	24500	23500	-	ohms
Transconductance (Per tube) . . . . .	5500	5700	-	μmhos
Effective Load Resistance (Plate-to-plate) . . . . .	5000	5000	5000	ohms
Total Harmonic Distortion . . . . .	2	2	2	per cent
Maximum-Signal Power Output . . . . .	14.5	17.5	18.5	watts

### Maximum Ratings: PUSH-PULL CLASS AB<sub>1</sub> AMPLIFIER

(Same as for single-tube class A<sub>1</sub> amplifier)

#### Typical Operation (Values are for two tubes):

	Fixed Bias	Cathode Bias	
Plate Supply Voltage . . . . .	360	360	360 volts
Grid-No.2 Supply Voltage . . . . .	270	270	270 volts
Grid-No.1 Voltage . . . . .	-22.5	-22.5	- volts
Cathode-Bias Resistor . . . . .	-	-	250 ohms
Peak AF Grid-No.1-to-Grid-No.1 Voltage . . . . .	45	45	40.6 volts
Zero-Signal Plate Current . . . . .	88	88	88 ma
Maximum-Signal Plate Current . . . . .	132	140	100 ma
Zero-Signal Grid-No.2 Current . . . . .	5	5	5 ma
Maximum-Signal Grid-No.2 Current . . . . .	15	11	17 ma
Effective Load Resistance (Plate-to-plate) . . . . .	6600	3800	9000 ohms
Total Harmonic Distortion . . . . .	2	2	4 per cent
Maximum-Signal Power Output . . . . .	26.5	18	24.5 watts

### Maximum Ratings: PUSH-PULL CLASS AB<sub>2</sub> AMPLIFIER

(Same as for single-tube class A<sub>1</sub> amplifier)

#### Typical Operation (Values are for two tubes):

	Fixed Bias	
Plate Voltage . . . . .	360	360 volts
Grid-No.2 Voltage . . . . .	225	270 volts
Grid-No. 1 Voltage . . . . .	-18	-22.5 volts
Peak AF Grid-No.1-to-Grid-No.1 Voltage . . . . .	52	72 volts
Zero-Signal Plate Current . . . . .	78	88 ma
Maximum-Signal Plate Current . . . . .	142	205 ma
Zero-Signal Grid-No.2 Current . . . . .	3.5	5 ma
Maximum-Signal Grid-No.2 Current . . . . .	11	16 ma
Effective Load Resistance (Plate-to-plate) . . . . .	6000	3800 ohms
Total Harmonic Distortion . . . . .	2	2 per cent
Maximum-Signal Power Output . . . . .	31	47 watts

#### Maximum Circuit Values:

Grid-No.1-Circuit Resistance:		
For fixed-bias operation . . . . .	0.1 max	megohm
For cathode-bias operation . . . . .	0.5 max	megohm

## INSTALLATION AND APPLICATION

Types 6L6 and 6L6-G require an octal socket and may be mounted in any position. Outlines 7 and 51, respectively, OUTLINES SECTION. It is especially important that these tubes, like other power-handling tubes, be adequately ventilated.

The heater is designed to operate at 6.3 volts. The transformer supplying this voltage should be designed to operate the heater at this recommended value for full-load operating conditions at average line voltage. Under the maximum grid-No.2- and plate-dissipation conditions, the heater voltage should never fluctuate so that it exceeds 7.0 volts. For cathode connection, refer to type 6AQ5.

In all services, precautions should be taken to insure that the dissipation rating is not exceeded with expected line-voltage variations, especially in the cases of fixed-bias operation. When the push-pull connection is used, fixed-bias values up to 10 per cent of each typical grid-No.2 voltage can be used without increasing distortion.

As class A<sub>1</sub> power amplifiers, the 6L6 and 6L6-G may be operated as shown in the tabulated data. The values cover cathode- and fixed-bias operation for both types where used as beam power tubes as well as where they are connected as triodes and have been determined on the basis that no grid current flows during any part of the input-signal swing. The second harmonics can easily be eliminated by the use of push-pull circuits. In single-tube amplifiers with resistance-coupled input, the second harmonics can be minimized by generating out-of-phase second harmonics in the pre-amplifier.

As push-pull class AB<sub>1</sub> power amplifiers, the 6L6 and 6L6-G may be operated as shown in the tabulated data. The values shown cover cathode- and fixed-

bias operation and have been determined on the basis that no grid current flows during any part of the input-signal swing.

As push-pull class AB<sub>2</sub> power amplifiers, the 6L6 and the 6L6-G may be operated as shown in the tabulated data. The values cover operation with fixed bias and have been determined on the basis that some grid current flows during the most positive swing of the input signal.

Refer to CIRCUIT SECTION for circuits employing the 6L6 or 6L6-G, and to the ELECTRON TUBE APPLICATIONS SECTION for discussion of inverse-feedback arrangements.

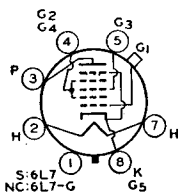
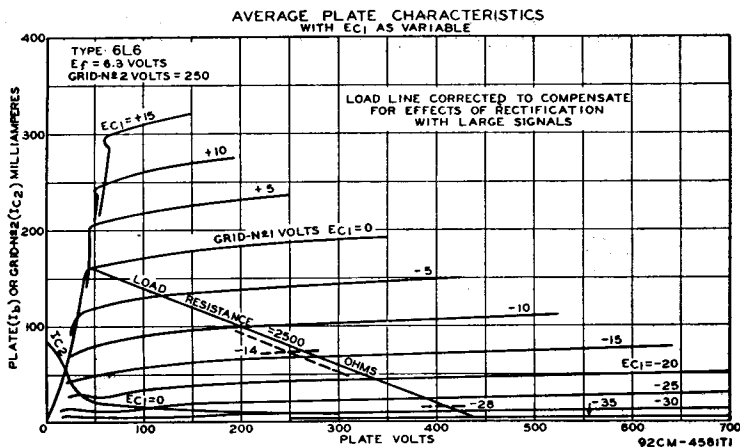

## PENTAGRID MIXER

Metal type 6L7 and glass-octal type 6L7-G are used as mixers in superheterodyne circuits having a separate oscillator stage as well as in other applications where dual control

is desirable in a single stage. The two separate control grids are shielded from each other and the coupling effects between oscillator and signal circuits are very small. For additional information, refer to *Frequency Conversion*, ELECTRON TUBE APPLICATIONS SECTION. Outlines 4 and 38, respectively, OUTLINES SECTION. Heater volts (ac/dc), 6.3; amperes, 0.3. Maximum ratings as mixer: plate volts, 300; grids-No.2-and-No.4 volts, 150; plate dissipation, 1.0 watt; grids-No.2-and-No.4 input, 1.5 watts. Typical operation as mixer (values recommended for all-wave receivers): plate volts, 250; grids-No.2-and-No.4 volts, 150; grid-No.1 (signal-grid) volts,  $-6$  min; grid-No.3 (oscillator-grid) volts,  $-15$ ; peak oscillator volts applied to grid-No.3,  $18$  min; plate ma, 3.3; grids-No.2-and-No.4 ma, 9.2; plate resistance, greater than 1 megohm; conversion transconductance,  $350 \mu\text{mhos}$ ; grid-No.1 volts for  $5 \mu\text{mhos}$  conversion transconductance,  $-45$ . The dc resistance in the grid-No.3 circuit should be limited to 50000 ohms. Type 6L7-G is a DISCONTINUED type listed for reference only.

# 6L7

# 6L7-G

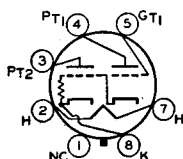

## DIRECT-COUPLED POWER TRIODE

Glass octal type used as class A<sub>1</sub> power amplifier. Outline 41, OUTLINES SECTION. Heater volts (ac/dc), 6.3; amperes, 0.8. For electrical characteristics, refer to type 6B5. Type 6N6-G is a DISCONTINUED type listed for reference only.

# 6N6-G

**HIGH-MU TWIN POWER TRIODE**

**6N7  
6N7-GT**

Metal type 6N7 and glass-octal type 6N7-GT used in output stage of radio receivers as class B power amplifier or with units in parallel as a class A<sub>1</sub> amplifier to drive a 6N7 or 6N7-GT

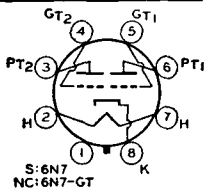

as a class B amplifier. Outlines 6 and 23, respectively, OUTLINES SECTION. Tubes require octal socket and may be mounted in any position. For typical operation as a resistance-coupled amplifier, refer to Chart 6, RESISTANCE-COUPLED AMPLIFIER SECTION. For class B amplifier considerations, refer to ELECTRON TUBE APPLICATIONS SECTION. Type 6N7 is used principally for renewal purposes.

HEATER VOLTAGE (AC/DC).....	6.8	volts
HEATER CURRENT.....	0.8	ampere

**CLASS B POWER AMPLIFIER**

Maximum Ratings (Each Unit):

PLATE VOLTAGE.....	300 max	volts
PEAK PLATE CURRENT.....	125 max	ma
AVERAGE PLATE DISSIPATION.....	5.5 max	watts
PEAK HEATER-CATHODE VOLTAGE:		
Heater negative with respect to cathode.....	90 max	volts
Heater positive with respect to cathode.....	90 max	volts

Typical Operation (Both Units):

Plate-Supply Impedance.....	0	1000	ohms
Effective Grid-Circuit Impedance.....	0	516**	ohms
Plate Voltage.....	300	300	volts
Grid Voltage.....	0	0	volts
Peak AF Grid-to-Grid Voltage.....	58	82	volts
Zero-Signal DC Plate Current.....	35	35	ma
Maximum-Signal DC Plate Current.....	70	70	ma
Peak Grid Current (Each Unit).....	20	22	ma
Effective Load Resistance (Plate to plate).....	8000	8000	ohms
Total Harmonic Distortion.....	4	8	per cent
Maximum-Signal Power Output.....	10	10	watts

\*\* At 400 cycles per second for class B stage in which the effective resistance per grid circuit is 500 ohms, and the leakage reactance of the coupling transformer is 50 millihenries. The driver stage should be capable of supplying the grids of the class B stage with the specified values at low distortion.

**CLASS A<sub>1</sub> AMPLIFIER**

Both grids connected together at socket; likewise, both plates

Maximum Ratings:

PLATE VOLTAGE.....	300 max	volts
PLATE DISSIPATION (Per plate).....	1.0 max	watt
PEAK HEATER-CATHODE VOLTAGE:		
Heater negative with respect to cathode.....	90 max	volts
Heater positive with respect to cathode.....	90 max	volts

Typical Operation:

Plate Voltage.....	250	300	volts
Grid Voltage.....	-5	-6	volts
Amplification Factor.....	35	35	
Plate Resistance.....	11300	11000	ohms
Transconductance.....	3100	3200	μmhos
Plate Current.....	6	7	ma

Plate Load—Depends largely on the design factors of the class B amplifier. In general, the load will be between 20000 and 40000 ohms.

Power Output—Under maximum voltage conditions, upwards of 400 milliwatts can be obtained.

**MEDIUM-MU TRIODE**

Glass octal type used as detector, amplifier, or oscillator in radio receivers. Outline 23, OUTLINES SECTION. This type may be supplied with pin No.1 omitted. Tube requires octal socket. Heater volts (ac/dc), 6.3; amperes, 0.3. Except for interelectrode capacitances, this type is identical electrically with type 76. Type 6P5-GT is a DISCONTINUED type listed for reference only.

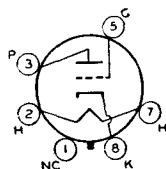

**6P5-GT**

**TRIODE—PENTODE**

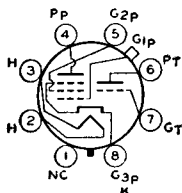

Glass octal type used as an amplifier. Outline 38, OUTLINES SECTION. Heater volts (ac/dc), 6.3; amperes, 0.3. Except for inter-electrode capacitances, this type is identical electrically with type 6F7. Type 6P7-G is a DISCONTINUED type listed for reference only.

**6P7-G**

**TWIN DIODE—HIGH-MU TRIODE**

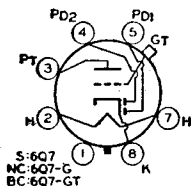

Metal type 6Q7 and glass-octal types 6Q7-G and 6Q7-GT used as combined detector, amplifier, and avc tubes in radio receivers. Outlines 4, 38, and 24, respectively, OUTLINES SECTION. Types 6Q7 and 6Q7-GT are used principally for renewal purposes. Type 6Q7-G is a DISCONTINUED type listed for reference only. Tubes require octal socket and may be mounted in any position. Heater volts (ac/dc),

**6Q7**  
**6Q7-G**  
**6Q7-GT**

6.3; amperes, 0.3. For heater and cathode considerations, refer to type 6AV6. These types are similar electrically in most respects to types 6SQ7 and 6AT6. Maximum ratings and typical operation of the triode unit as a class A<sub>1</sub> amplifier are the same as those for type 6AT6 except that with a plate voltage of 100 volts, the transconductance is 1200  $\mu$ mhos and the plate resistance 58000 ohms. The triode unit is recommended for use only in resistance-coupled circuits; refer to Chart 7, RESISTANCE-COUPLED AMPLIFIER SECTION. For triode-unit, grid-bias considerations and diode curves, refer to type 6AV6.

**TWIN DIODE—  
MEDIUM-MU TRIODE**

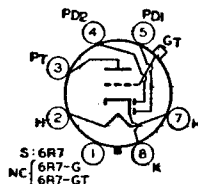

Metal type 6R7 and glass-octal types 6R7-G and 6R7-GT used as combined-detector, amplifier, and avc tubes. Outlines 4, 38, and 21, respectively, OUTLINES SECTION. Type 6R7-GT may be supplied with pin No.1 omitted. Tubes require octal sockets. Within their maximum ratings, these types are identical electrically with type 6BF6 except for capacitances. Maximum ratings of triode unit as class

**6R7**  
**6R7-G**  
**6R7-GT**

A<sub>1</sub> amplifier: plate volts, 250 max; plate dissipation, 2.5 max watts. For typical operation as a resistance-coupled amplifier, refer to Chart 9, RESISTANCE-COUPLED AMPLIFIER SECTION. Types 6R7-G and 6R7-GT are DISCONTINUED types listed for reference only. Type 6R7 is used principally for renewal purposes.

**MEDIUM-MU TRIODE**

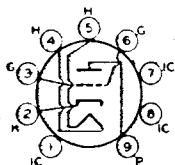

Miniature types having high permeance used as vertical deflection amplifiers in television receivers. Type 6S4-A has a controlled heater warm-up time for use in television receivers employing series-connected heater strings. Outline 14, OUTLINES SECTION. Tubes require miniature nine-contact socket and may be mounted in any position. For heater and cathode considerations, refer to type 6AQ5. Type 6S4 is used principally for renewal purposes.

**6S4**  
**6S4-A**

HEATER VOLTAGE (AC/DC) .....	6.3	volts
HEATER CURRENT .....	0.6	ampere
HEATER WARM-UP TIME (Average)* for 6S4-A .....	11	seconds

\* For definition of heater warm-up time and method for determining it, see type 6CG7.

<b>Characteristics:</b>	<b>CLASS A<sub>1</sub> AMPLIFIER</b>	
Plate Voltage .....	250	volts
Grid Voltage .....	-8	volts
Amplification Factor .....	16	

# RCA Receiving Tube Manual

Plate Resistance (Approx.)	3600	ohms
Transconductance	4500	$\mu$ mhos
Plate Current	26	ma
Plate Current for grid voltage of -15 volts	4.5	ma
Grid Voltage (Approx.) for plate current of 50 $\mu$ a.	-23	volts

## VERTICAL DEFLECTION AMPLIFIER

*For operation in a 525-line, 30-frame system*

### Maximum Ratings:

DC PLATE VOLTAGE	500 max	volts
PEAK POSITIVE-PULSE PLATE VOLTAGE† (Absolute maximum)	2200 max	volts
PEAK NEGATIVE-PULSE GRID VOLTAGE	-250 max	volts
CATHODE CURRENT:		
Peak	105 max	ma
Average	30 max	ma
PLATE DISSIPATION	7.5 max	watts
PEAK HEATER-CATHODE VOLTAGE:		
Heater negative with respect to cathode	200 max	volts
Heater positive with respect to cathode	200 max	volts

### Maximum Circuit Values:

Grid-Circuit Resistance:		
For cathode-bias operation	2.2 max	megohms

† The duration of the voltage pulse must not exceed 15 per cent of one vertical scanning cycle. In a 525-line, 30-frame system, 15 per cent of one vertical scanning cycle is 2.5 milliseconds.

° Under no circumstances should this absolute value be exceeded.

■ The dc component must not exceed 100 volts.

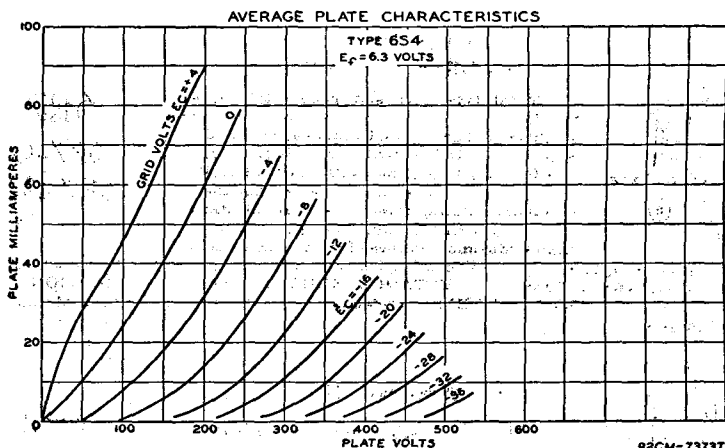

## REMOTE-CUTOFF PENTODE

Metal type 6S7 and glass-octal type 6S7-G used in rf and if stages of automobile receivers employing avc. Outlines 5 and 38, respectively, OUTLINES SECTION. Type 6S7 is used principally for renewal purposes. Type 6S7-G is a DISCONTINUED type listed for reference only. Tubes require octal socket and may be mounted in any position. Heater volts, 6.3; amperes, 0.15. Typical operation and maximum

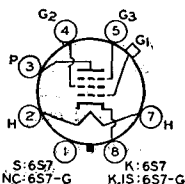

6S7  
6S7-G

ratings as Class A<sub>1</sub> amplifier: plate volts, 250 (300 max); grid-No.2 volts, see curve page 67; grid-No.2 supply volts, 300 max; grid-No.1 volts, -3 (0 min); grid No.3 connected to cathode at socket; plate ma., 8.5; grid-No.2 ma., 2; plate resistance, 1.0 megohm; transconductance, 1750  $\mu$ mhos; grid-No.1 volts for transconductance of 10  $\mu$ mhos, -38; plate dissipation, 2.25 max watts; grid-No.2 input: for grid-No.2 voltages up to 150 volts, 0.25 max watt; for grid-No.2 voltages between 150 and 300 volts, see curve page 67. For typical operation as a resistance-coupled amplifier, refer to Chart 15, RESISTANCE-COUPLED AMPLIFIER SECTION.

**TRIPLE DIODE—HIGH-MU TRIODE**

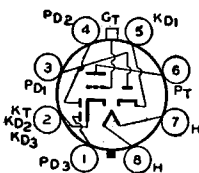

Glass octal type used as audio amplifier, AM detector, and FM detector in AM/FM receivers. Diode unit No.2 is used for AM detection, and diode units No.1 and No.3 are used for FM detection. The grid of the high-mu triode is brought out to a top cap. Outline 28, OUTLINES SECTION. Tube requires octal socket and may be mounted in any position. For

**6S8-GT**

heater and cathode considerations, refer to type 6AV6. For typical operation of triode unit as a resistance-coupled amplifier, refer to Chart 4, RESISTANCE-COUPLED AMPLIFIER SECTION. Heater volts (ac/dc), 6.3; amperes, 0.3. Maximum ratings of triode unit as class A<sub>1</sub> amplifier: plate volts, 300 max; plate dissipation, 0.5 max watts; peak heater-cathode volts, 90 max. Maximum plate ma. for diode units, 1.0 max (each unit). For diode operation curves, refer to type 6AV6. Type 6S8-GT is used principally for renewal purposes.

**Characteristics:**

**TRIODE UNIT AS CLASS A<sub>1</sub> AMPLIFIER**

Plate Voltage	50	100	250	volts
Grid Voltage	-	-1	-2	volts
Grid Resistor	10	0	0	megohms
Amplification Factor	85	100	100	
Plate Resistance	285000	110000	91000	ohms
Transconductance	300	900	1100	μmhos
Plate Current	0.07	0.4	0.9	ma

**PENTAGRID CONVERTER**

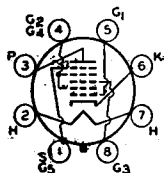

Metal type 6SA7 and glass-octal type 6SA7-GT used as converters in superheterodyne circuits. They are similar in performance to type 6BE6. For general discussion of pentagrid types, see *Frequency Conversion* in ELECTRON TUBE APPLICATIONS SECTION. Both tubes have excellent frequency stability. Type 6SA7-GT is used principally for renewal purposes.

**6SA7**

**6SA7-GT**

HEATER VOLTAGE (AC/DC)	6.3	volts
HEATER CURRENT	0.3	ampere

**DIRECT INTERELECTRODE CAPACITANCES:**

	6SA7	6SA7-GT	
Grid No.3 to All Other Electrodes (RF Input)	9.5*	9.5**	μf
Plate to All Other Electrodes (Mixer Output)	9.5*	9.5**	μf
Grid No.1 to All Other Electrodes (Osc. Input)	7*	8**	μf
Grid No.3 to Plate	0.25 max*	0.5 max**	μf
Grid No.3 to Grid No.1	0.15 max*	0.4 max**	μf
Grid No.1 to Plate	0.06 max*	0.2 max**	μf
Grid No.1 to Shell, Grid No.5, and All Other Electrodes except Cathode	4.4	-	μf
Grid No.1 to All Other Electrodes except Cathode and Grid No.5	-	5	μf
Grid No.1 to Cathode	2.6	-	μf
Grid No.1 to Cathode and Grid No.5	-	3	μf
Cathode to Shell, Grid No.5, and All Other Electrodes except Grid No.1	5	-	μf
Cathode and Grid No.5 to All Other Electrodes except Grid No.1	-	14	μf

\* With shell connected to cathode. \*\* With external shield connected to cathode.

**CONVERTER SERVICE**

Maximum Ratings:		
PLATE VOLTAGE	300 max	volts
GRIDS-NO.2-AND-NO.4 VOLTAGE	100 max	volts
GRIDS-NO.2-AND-NO.4 SUPPLY VOLTAGE	300 max	volts

GRID-NO.3 VOLTAGE:		
Negative bias value.....	-50 max	volts
Positive bias value.....	0 max	volts
PLATE DISSIPATION.....	1.0 max	watt
GRIDS-NO.2-AND-NO.4 INPUT.....	1.0 max	watt
TOTAL CATHODE CURRENT.....	14 max	ma
PEAK HEATER-CATHODE VOLTAGE:		
Heater negative with respect to cathode.....	90 max	volts
Heater positive with respect to cathode.....	90 max	volts

Typical Operation:	Self-Excitation†		Separate Excitation		
Plate Voltage.....	100	250	100	250	volts
Grids-No.2-and-No.4 Voltage.....	100	100	100	100	volts
Grid-No.3 (Control-Grid) Voltage.....	0	0	-2	-2	volts
Grid-No.1 Resistor.....	20000	20000	20000	20000	ohms
Plate Resistance (Approx.).....	0.5	1.0	0.5	1.0	megohm
Conversion Transconductance.....	425	450	425	450	μmhos
Grid-No.3 Voltage (Approx.) for transconductance of 10 μmhos.....	-25	-25	-25	-25	volts
Grid-No.3 Voltage (Approx.) for conversion transconductance of 100 μmhos....	-9	-9	-9	-9	volts
Plate Current.....	3.3	3.5	3.3	3.5	ma
Grids-No.2-and-No.4 Current.....	8.5	8.5	8.5	8.5	ma
Grid-No.1 Current.....	0.5	0.5	0.5	0.5	ma
Total Cathode Current.....	12.3	12.5	12.3	12.5	ma

NOTE: The transconductance between grid No.1 and grids No.2 and No.4 connected to plate (not oscillating) is approximately 4500 μmhos under the following conditions: grids No.1, No.3, and shell at 0 volts; grids No.2 and No.4 and plate at 100 volts.

† Characteristics are approximate only and are shown for a Hartley circuit with a feedback of approximately 2 volts peak in the cathode circuit.

## INSTALLATION AND APPLICATION

Types 6SA7 and 6SA7-GT require octal socket and may be mounted in any position. Outlines 3 and 23, respectively, OUTLINES SECTION. For heater and cathode considerations, refer to type 6AV6.

Because of the special structural arrangement of the 6SA7 and 6SA7-GT, a change in signal-grid voltage produces little change in cathode current. Consequently, an rf voltage on the signal grid produces little modulation of the electron current flowing in the cathode circuit. This feature is important because it is desirable that the impedance in the cathode circuit should produce little degeneration or regeneration of the signal-frequency input and intermediate-frequency output. Another important feature is that, because signal-grid voltage has little effect on the space charge near the cathode, changes in avc bias produce little change in oscillator transconductance and in the input capacitance of the No.1 grid. There is, therefore, little detuning of the oscillator by avc bias.

A typical self-excited oscillator circuit for use with the 6SA7 will be similar to that for the 6BE6 in the CIRCUIT SECTION. For operation in frequency bands lower than approximately 6 megacycles per second, the circuit should generally be adjusted to provide, with recommended values of plate and grids-No.2-and-No.4 voltage, a cathode voltage of approximately 2 volts peak, and a grid-No.1 current of 0.5 milliampere through a grid resistor of 20000 ohms. In the low- and medium-frequency bands, the recommended oscillator conditions can be readily met. However, in the band covering frequencies higher than approximately 6 megacycles per second, the tank-circuit impedance is generally so low that it is not easy to obtain these oscillator conditions. For optimum performance in this band, it is generally best to adjust the oscillator circuit for maximum conversion gain at the low-frequency end of the band. Maximum conversion gain at this end of the band is usually obtained by adjustment of the oscillator circuit to give a cathode voltage of approximately 2 volts peak and a grid-No.1 current of 0.20 to 0.25 milliampere, with a grid resistor of 20000 ohms.

In the 6SA7 and 6SA7-GT operation characteristics curves with self-excitation,  $E_k$  is the voltage across the oscillator-coil section between cathode and ground;  $E_g$  is the oscillator voltage between cathode and grid.



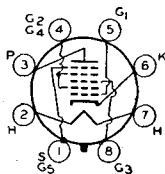
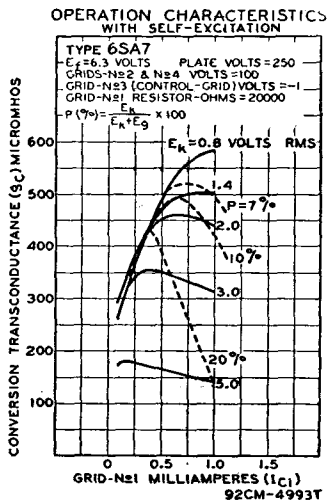
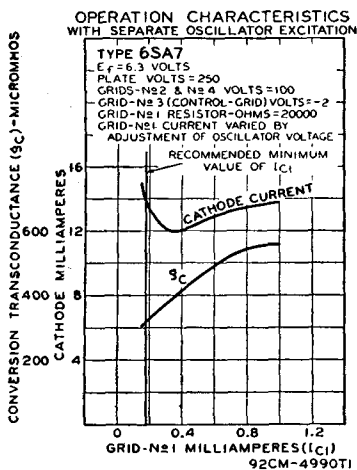

## PENTAGRID CONVERTER

Metal type used as converter in superheterodyne circuits. Because of its high conversion and oscillator transductance, it is especially useful in FM converter service in the 100-megacycle region. The 6SB7-Y has a micanol base which minimizes drift in oscillator frequency during warm-up period. For general discussion of pentagrid types, see *Frequency Conversion* in ELECTRON TUBE APPLICATIONS SECTION. Outline 3, OUTLINES SECTION.

# 6SB7-Y

version in ELECTRON TUBE APPLICATIONS SECTION. Outline 3, OUTLINES SECTION. Tube requires octal socket and may be mounted in any position. For heater and cathode considerations, refer to type 6AV6. Heater volts (ac/dc), 6.3; amperes, 0.3. Maximum ratings: plate volts, 300 max; grids-No.2-and-No.4 volts, 100 max; grids-No.2-and-No.4 supply volts, 300 max; plate dissipation, 2.0 max watts; grids-No.2-and-No.4 input, 1.5 max watts; total cathode ma., 22 max; grid-No.3 volts, 100 max (negative bias), 0 max (positive bias); peak heater-cathode volts, 90 max. Type 6SB7-Y is used principally for renewal purposes.

## CONVERTER SERVICE

### Typical Operation (Separate Excitation):\*

Plate Voltage.....	100	250	volts
Grids-No.2-and-No.4 (Screen-Grid) Voltage.....	100	100	volts
Grid-No.3 (Control-Grid) Voltage.....	-1.0	-1.0	volt
Grid-No.1 (Oscillator Grid) Resistor.....	20000	20000	ohms
Plate Resistance (Approx.).....	0.5	1.0	megohm
Conversion Transductance.....	900	950	μmhos
Conversion Transductance with grid-No.3 voltage of -20 volts.....	3.5	3.5	μmhos
Plate Current.....	3.6	3.8	ma
Grids-No.2-and-No.4 Current.....	10.2	10	ma
Grid-No.1 Current.....	0.35	0.35	ma
Total Cathode Current.....	14.2	14.2	ma

\* The characteristics shown with separate excitation correspond very closely with those obtained in a self-excited oscillator circuit operating with zero bias.

### Typical Operation in FM Band (88-108 Mc):

Plate Voltage.....	250	volts
Grids-No.2-and-No.4 Supply Voltage.....	250	volts
Grids-No.2-and-No.4 Resistor.....	12000	ohms
Grid-No.1 Resistor.....	22000	ohms

Signal Frequency.....	88	108	Mc
Oscillation Frequency.....	98.7	118.7	Mc
Plate Current.....	6.8	6.5	ma
Grids-No.2-and-No.4 Current.....	12.6	12.5	ma
Grid-No.1 Current.....	0.130	0.140	ma

NOTE: The transconductance between grid No.1 and grids No.2 and No.4 connected to plate (not oscillating) is approximately 8000  $\mu$ hos under the following conditions: signal applied to grid No.1 at zero bias; grids No.2 and No.4 and plate at 100 volts; grid No.3 grounded. Under the same conditions, the plate current is 82 milliamperes and the amplification factor is 16.5.

## HIGH-MU TWIN TRIODE

# 6SC7

Metal type used as phase inverter or voltage amplifier in radio equipment. Except for common cathode, each triode is independent of the other. Outline 3, OUTLINES SECTION.

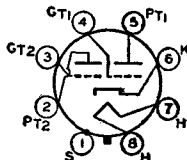

Tube requires octal socket and may be mounted in any position. For heater and cathode considerations, refer to type 6AV6. For typical operation as a resistance-coupled amplifier, refer to Chart 16, RESISTANCE-COUPLED AMPLIFIER SECTION.

HEATER VOLTAGE (AC/DC).....	6.3	volts
HEATER CURRENT.....	0.3	ampere
DIRECT INTERELECTRODE CAPACITANCES (Each Unit, Approx.):		
Grid to Plate.....	2	$\mu$ mf
Grid to Cathode, Heater, and Shell.....	2	$\mu$ mf
Plate to Cathode, Heater, and Shell.....	3	$\mu$ mf

### Maximum Ratings:

### CLASS A<sub>1</sub> AMPLIFIER

PLATE VOLTAGE.....	250 <i>max</i>	volts
PEAK HEATER-CATHODE VOLTAGE:		
Heater negative with respect to cathode.....	90 <i>max</i>	volts
Heater positive with respect to cathode.....	90 <i>max</i>	volts

### Characteristics: (Each Unit):

Plate Voltage.....	250	volts
Grid Voltage.....	-2	volts
Amplification Factor.....	70	
Plate Resistance (Approx.).....	53000	ohms
Transconductance (Approx.).....	1825	$\mu$ hos
Plate Current.....	2	ma

AVERAGE PLATE CHARACTERISTICS  
EACH TRIODE UNIT

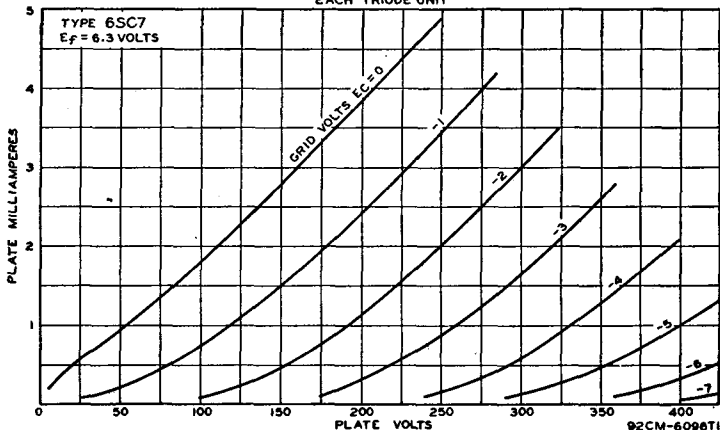

**HIGH-MU TRIODE**

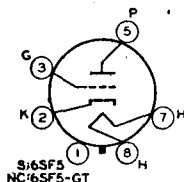

Metal type 6SF5 and glass-octal type 6SF5-GT are used in resistance-coupled amplifier circuits. Outlines 3 and 23, respectively, OUTLINES SECTION. Type 6SF5-GT may be supplied with pin No.1 omitted. Tubes require octal socket and may be mounted in any position. Characteristics, application, and references under type 6F5 apply to types 6SF5 and 6SF5-GT. Heater volts (ac/dc), 6.3; amperes, 0.3. Type 6SF5-GT is used principally for renewal purposes.

**6SF5**  
**6SF5-GT**

**DIODE—  
REMOTE-CUTOFF PENTODE**

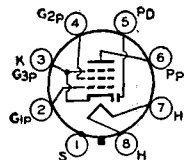

Metal type used as combined rf or if amplifier and detector or avc tube in radio receivers. Also used as resistance-coupled af amplifier. Outline 3, OUTLINES SECTION. Tube requires octal socket and may be mounted in any position. Heater volts (ac/dc), 6.3; amperes, 0.3. For heater and cathode considerations, refer to type 6AV6. For typical operation as a resistance-coupled amplifier, refer to Chart 18, RESISTANCE-COUPLED AMPLIFIER SECTION.

**6SF7**

Type 6SF7 is used principally for renewal purposes.

**Maximum Ratings:**

**PENTODE UNIT AS CLASS A<sub>1</sub> AMPLIFIER**

PLATE VOLTAGE.....	300 max	volts
GRID-NO.2 (SCREEN-GRID) VOLTAGE.....	100 max	volts
GRID-NO.2 SUPPLY VOLTAGE.....	300 max	volts
GRID-NO.1 (CONTROL-GRID) VOLTAGE, Positive Bias Value.....	0 max	volts
PLATE DISSIPATION.....	3.5 max	watts
GRID-NO.2 INPUT.....	0.5 max	watt
<b>PEAK HEATER-CATHODE VOLTAGE:</b>		
Heater negative with respect to cathode.....	90 max	volts
Heater positive with respect to cathode.....	90 max	volts

**Characteristics:**

Plate Voltage.....	100	250	volts
Grid-No.2 Voltage.....	100	100	volts
Grid-No.1 Voltage.....	-1	-1	volt
Plate Resistance (Approx.).....	0.2	0.7	megohm
Transconductance.....	1975	2050	μmhos
Grid-No.1 Voltage (Approx.) for transconductance of 10 μmhos.....	-35	-35	volts
Plate Current.....	13.5	13.9	ma
Grid-No. 2 Current.....	4.3	4.1	ma

**DIODE UNIT**

The diode plate is placed around the cathode, the sleeve of which is common to the pentode unit. For diode operation curves, refer to type 6AV6.

**REMOTE-CUTOFF PENTODE**

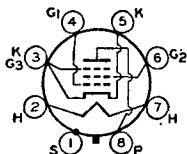

Metal type used as rf amplifier in high-frequency and wide-band applications. Features high transconductance with low grid-No.1-to-plate capacitance. Suitable for frequencies

**6SG7**

up to 18 megacycles per second (approx.). Two separate cathode terminals enable the input and output circuits to be effectively isolated from each other. Outline 3, OUTLINES SECTION. Tube requires octal socket and may be mounted in any position. For heater and cathode considerations, refer to type 6AV6.

HEATER VOLTAGE (AC/DC).....	6.3	volts
HEATER CURRENT.....	0.3	ampere
<b>DIRECT INTERELECTRODE CAPACITANCES:</b>		
Grid No.1 to Plate.....	0.008 max	μμf
Grid No.1 to Cathode, Heater, Grid No.2, Grid No.3, and Shell.....	8.5	μμf
Plate to Cathode, Heater, Grid No.2, Grid No.3, and Shell.....	7.0	μμf

**Maximum Ratings:**
**CLASS A<sub>1</sub> AMPLIFIER**

PLATE VOLTAGE.....			300 max	volts
GRID-NO.2 (SCREEN-GRID) VOLTAGE.....			See curve page 67	
GRID-NO.2 SUPPLY VOLTAGE.....			300 max	volts
GRID-NO.1 (CONTROL-GRID) VOLTAGE, Positive Bias Value.....			0 max	volts
PLATE DISSIPATION.....			3 max	watts
GRID-NO.2 INPUT:				
For grid-No.2 voltages up to 150 volts.....			0.6 max	watt
For grid-No.2 voltages between 150 and 300 volts.....			See curve page 67	
PEAK HEATER-CATHODE VOLTAGE:				
Heater negative with respect to cathode.....			90 max	volts
Heater positive with respect to cathode.....			90 max	volts

**Characteristics:**

Plate Voltage.....	100	250	250	volts
Grid-No.2 Voltage.....	100	125	150	volts
Grid-No.1 Voltage.....	-1	-1	-2.5	volts
Plate Resistance (Approx.).....	0.25	0.9	*	megohm
Transconductance.....	4100	4700	4000	μmhos
Grid-No.1 Voltage (Approx.) for transconductance of 40 μmhos.....	-11.5	-14	-17.5	volts
Plate Current.....	8.2	11.8	9.2	ma
Grid-No.2 Current.....	3.2	4.4	3.4	ma

\* Greater than 1 megohm.

## SHARP-CUTOFF PENTODE

# 6SH7

Metal type used as rf amplifier in high-frequency, wide-band applications and as a limiter tube in FM equipment. Similar electrically to miniature type 6AU6. It features high

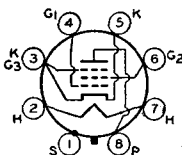

transconductance and low grid-No.1-to-plate capacitance. Outline 3, **OUTLINES SECTION**. Tube requires octal socket and may be mounted in any position. Two separate cathode terminals enable the input and output circuits to be isolated effectively from each other. This type is not recommended for high-gain, audio-amplifier applications because undesirable hum may be encountered. For heater and cathode considerations, refer to type 6AV6. For typical operation as a resistance-coupled amplifier, refer to Chart 8, **RESISTANCE-COUPLED AMPLIFIER SECTION**.

HEATER VOLTAGE (AC/DC).....	6.3	volts
HEATER CURRENT.....	0.3	ampere
DIRECT INTERELECTRODE CAPACITANCES:		
Grid No.1 to Plate.....	0.003 max	μμf
Grid No.1 to Cathode, Heater, Grid No.2, Grid No.3, and Shell.....	8.5	μμf
Plate to Cathode, Heater, Grid No.2, Grid No.3, and Shell.....	7.0	μμf

**Maximum Ratings:**
**CLASS A<sub>1</sub> AMPLIFIER**

PLATE VOLTAGE.....			300 max	volts
GRID NO.2 (SCREEN-GRID) VOLTAGE.....			See curve page 67	
GRID-NO.2 SUPPLY VOLTAGE.....			300 max	volts
PLATE DISSIPATION.....			3 max	watts
GRID-NO.2 INPUT:				
For grid-No.2 voltages up to 150 volts.....			0.7 max	watt
For grid-No.2 voltages between 150 and 300 volts.....			See curve page 67	
GRID-NO.1 (CONTROL-GRID) VOLTAGE, Positive Bias Value.....			0 max	volts
PEAK HEATER-CATHODE VOLTAGE:				
Heater negative with respect to cathode.....			90 max	volts
Heater positive with respect to cathode.....			90 max	volts

**Characteristics:**

Plate Voltage.....	100	250	volts
Grid-No.2 Voltage.....	100	150	volts
Grid-No.1 Voltage.....	-1	-1	volt
Plate Resistance (Approx.).....	0.35	0.9	megohm
Transconductance.....	4000	4900	μmhos
Grid-No.1 Voltage for plate current of 10 μa.....	-4.0	-5.5	volts
Plate Current.....	5.3	10.8	ma
Grid-No.2 Current.....	2.1	4.1	ma

SHARP-CUTOFF PENTODE

6SJ7  
6SJ7-GT

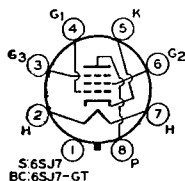

Metal type 6SJ7 and glass-octal type 6SJ7-GT are used as rf amplifiers and biased detectors. As a detector, either type is capable of delivering large audio-frequency output voltage with relatively small input voltage. Type 6SJ7-GT is used principally for renewal purposes.

HEATER VOLTAGE (AC/DC).....	6.3	volts
HEATER CURRENT.....	0.3	ampere
DIRECT INTERELECTRODE CAPACITANCES: <sup>o</sup>		
Pentode Connection:		
Grid No.1 to Plate.....	0.005 max	0.005 max    μuf
Grid No.1 to Cathode, Heater, Grid No.2, and Grid No.3..	6.0	7.0    μuf
Plate to Cathode, Heater, Grid No.2, and Grid No.3.....	7.0	7.0    μuf
Triode Connection:■		
Grid No.1 to Plate.....	2.8	2.8    μuf
Grid No.1 to Cathode and Heater.....	3.4	3.4    μuf
Plate to Cathode and Heater.....	11	11    μuf

<sup>o</sup> With shell or external shield connected to cathode.

■ With grids No.2 and No.3 connected to plate.

CLASS A<sub>1</sub> AMPLIFIER

Maximum Ratings:

	Triode Connection	Pentode Connection	
PLATE VOLTAGE.....	250 max	300 max	volts
GRID-NO.2 (SCREEN-GRID) VOLTAGE.....	-	See curve page 67	
GRID-NO.2 SUPPLY VOLTAGE.....	-	300 max	volts
GRID-NO.1 (CONTROL-GRID) VOLTAGE, Positive Bias Value....	0 max	0 max	volts
PLATE DISSIPATION.....	2.5 max	2.5 max	watts
GRID-NO.2 INPUT:			
For grid-No.2 voltages up to 150 volts.....		0.7 max	watt
For grid-No.2 voltages between 150 and 300 volts.....		See curve page 67	
PEAK HEATER-CATHODE VOLTAGE:			
Heater negative with respect to cathode.....	90 max	90 max	volts
Heater positive with respect to cathode.....	90 max	90 max	volts

Typical Operation:

	Triode Connection*		Pentode Connection		
Plate Voltage.....	180	250	100	250	volts
Grid-No.2 Voltage.....	-	-	100	100	volts
Grid-No.1 Voltage.....	-6	-8.5	-3	-3	volts
Grid No.3 (Suppressor Grid).....	-	-	Connected to cathode at socket		
Amplification Factor.....	19	19	-	-	
Plate Resistance.....	8250	7600	700000	↑	ohms
Transconductance.....	2300	2500	1675	1650	μmhos
Grid-No.1 Voltage for plate current					
of 10 μa.....	-	-	-8	-8	volts
Plate Current.....	6.0	9.2	2.9	3.0	ma
Grid-No.2 Current.....	-	-	0.9	0.8	ma

\* Grids No.2 and No.3 connected to plate.

↑ Greater than 1 megohm.

INSTALLATION AND APPLICATION

Types 6SJ7 and 6SJ7-GT require octal socket and may be mounted in any position. Outlines 3 and 25, respectively, OUTLINES SECTION. For heater and cathode considerations, refer to type 6AV6.

As a class A<sub>1</sub> amplifier, the 6SJ7 or 6SJ7-GT may be operated either as a pentode or as a triode, as shown under tabulated data. The grid-No.2 voltage for the 6SJ7 operated as a pentode may be obtained from a potentiometer or bleeder circuit across the B-supply device. Due to the grid-No.2-current characteristics of the 6SJ7, a resistor in series with the high-voltage supply may be employed for obtaining the grid-No.2 voltage, provided the cathode-resistor method of bias

control is used. This method, however, is not recommended if the high-voltage B-supply exceeds 300 volts.

As a **radio-frequency amplifier**, the 6SJ7 or 6SJ7-GT may be used particularly in applications where the rf signal applied to grid No.1 is relatively low, that is, of the order of a few volts. In such cases either grid-No.2 or grid-No.1 voltage (or both) may be varied to control the receiver volume. When larger signals are involved, a remote-cutoff amplifier tube should be employed to prevent the occurrence of excessive cross-modulation and modulation-distortion.

As an **audio-frequency amplifier** in resistance-coupled circuits, the 6SJ7 or 6SJ7-GT may be operated under conditions shown in Chart 19, RESISTANCE-COUPLED AMPLIFIER SECTION.

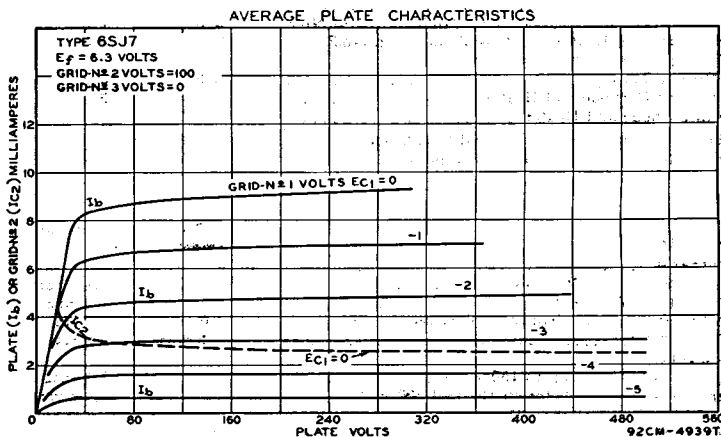

## REMOTE-CUTOFF PENTODE

Metal type 6SK7 and glass-octal type 6SK7-GT are used as rf or if amplifiers in radio receivers. They feature single-ended construction and interlead shields. Because of remote-cutoff

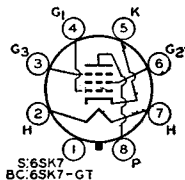

# 6SK7 6SK7-GT

characteristic, these types are able to handle large signal voltages without cross-modulation or modulation-distortion and are often used in receivers with avc. Type 6SK7-GT is used principally for renewal purposes.

HEATER VOLTAGE (AC/DC).....	6.3	volts
HEATER CURRENT.....	0.3	ampere
DIRECT INTERELECTRODE CAPACITANCES:		
Grid No.1 to Plate.....	0.003 max	μuf
Grid No.1 to Cathode, Heater, Grid No.2, and Grid No.3.....	6.0	μuf
Plate to Cathode, Heater, Grid No.2, and Grid No.3.....	7.0	μuf

\* With shell connected to cathode.

\*\* With external shield connected to cathode.

### Maximum Ratings:

### CLASS A<sub>1</sub> AMPLIFIER

PLATE VOLTAGE.....	300 max	volts
GRID-NO.2 (SCREEN-GRID) VOLTAGE.....	See curve page 67	
GRID-NO.2 SUPPLY VOLTAGE.....	300 max	volts
GRID-NO.1 (CONTROL-GRID) VOLTAGE, Positive Bias Value.....	0 max	volts
PLATE DISSIPATION.....	4.0 max	watts
GRID-NO.2 INPUT:		
For grid-No.2 voltages up to 150 volts.....	0.4 max	watt
For grid-No.2 voltages between 150 and 300 volts.....	See curve page 67	

# RCA Receiving Tube Manual

## PEAK HEATER-CATHODE VOLTAGE:

Heater negative with respect to cathode.....	90 max	volts
Heater positive with respect to cathode.....	90 max	volts

## Characteristics:

Plate Voltage.....	100	250	volts
Grid-No.2 Voltage.....	100	100	volts
Grid-No.1 Voltage.....	-1	-3	volts
Grid No.3 (Suppressor Grid).....	Connected to cathode at socket		
Plate Resistance (Approx.).....	0.12	0.8	megohm
Transconductance.....	2350	2000	$\mu$ mhos
Grid-No.1 Voltage for transconductance of 10 $\mu$ mhos.....	-35	-35	volts
Plate Current.....	13	9.2	ma
Grid-No.2 Current.....	4.0	2.6	ma

## INSTALLATION AND APPLICATION

Types 6SK7 and 6SK7-GT require octal socket and may be mounted in any position. Outlines 3 and 25, respectively, OUTLINES SECTION. For heater and cathode considerations, refer to type 6AV6.

Control-grid bias variation will be found effective in changing the volume of the receiver. In order to obtain adequate volume control, an available grid-bias voltage of approximately 50 volts will be required. The exact value will depend upon the circuit design and operating conditions. This voltage may be obtained, depending on the receiver requirements, from a potentiometer across a fixed supply voltage, from a variable cathode-bias resistor, from the avc system, or from a combination of these methods.

The grid-No.2 (screen-grid) voltage may be obtained from a potentiometer or bleeder circuit across the B-supply source, or through a dropping resistor from the plate supply. The use of series resistors for obtaining satisfactory control of grid-No.2 voltage in the case of four-electrode tubes is usually impossible because of secondary-emission phenomena. In the 6SK7, however, because grid No.3 practically removes these effects, it is possible to obtain grid-No.2 voltage through a series-dropping resistor from the plate supply or from some high intermediate voltage, provided the source does not exceed the plate-supply voltage. With this method, the grid-No.2-to-cathode voltage will fall off very little from minimum to maximum value of the resistor controlling cathode bias. In some cases, it may actually rise. This rise of grid-No.2-to-cathode voltage above the normal maximum value is allowable because both the grid-No.2 current and the plate current are reduced simultaneously by a sufficient amount to prevent damage to the tube. It should be recognized that, in general, the series-resistor method of obtaining grid-No.2 voltage from a higher voltage supply necessitates the use of the variable

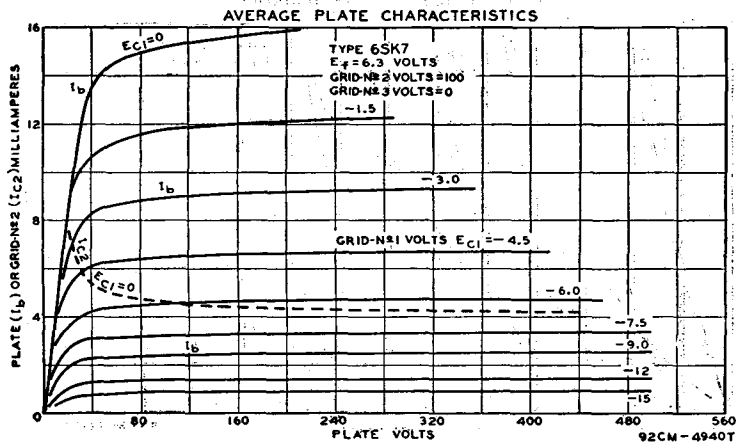

cathode-resistor method of controlling volume in order to prevent too high a voltage on grid No.2. When grid-No.2 and control-grid voltage are obtained in this manner, the remote "cutoff" advantage of the 6SK7 and 6SK7-GT can be fully realized. However, it should be noted that the use of a resistor in the grid-No.2 circuit will have an effect on the change in plate resistance with variation in grid-No.3 (suppressor-grid) voltage in case grid No.3 is utilized for control purposes.

Grid No.3 (suppressor grid) may be connected directly to the cathode or it may be made negative with respect to the cathode. For the latter condition, the grid-No.3 voltage may be obtained from a potentiometer or bleeder circuit, or from the avc system.

# 6SL7-GT

## HIGH-MU TWIN TRIODE

Glass octal type used as phase inverter or resistance-coupled amplifier in radio equipment. Outline 23, OUT-LINES SECTION. Tube requires octal socket and may be mounted in

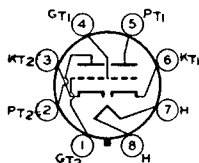

any position. Except for the common heater, each triode unit is independent of the other. For typical operation as phase inverter or resistance-coupled amplifier, refer to Chart 7, RESISTANCE-COUPLED AMPLIFIER SECTION. For heater and cathode considerations, refer to type 6AV6.

HEATER VOLTAGE (AC/DC).....	6.3	volts
HEATER CURRENT.....	0.3	ampere
DIRECT INTERELECTRODE CAPACITANCES (Approx.):*		
Grid to Plate.....	Unit No. 1	Unit No. 2
Grid to Cathode and Heater.....	2.8	2.8
Plate to Cathode and Heater.....	3.0	3.4
Plate to Cathode.....	3.8	3.2
		$\mu\text{f}$

\* With close-fitting shield connected to cathode.

### Maximum Ratings:

### CLASS A<sub>1</sub> AMPLIFIER (Each Unit)

PLATE VOLTAGE.....	300 max	volts
GRID VOLTAGE, Positive Bias Value.....	0 max	volts
PLATE DISSIPATION.....	1 max	watt
PEAK HEATER-CATHODE VOLTAGE:		
Heater negative with respect to cathode.....	90 max	volts
Heater positive with respect to cathode.....	96 max	volts

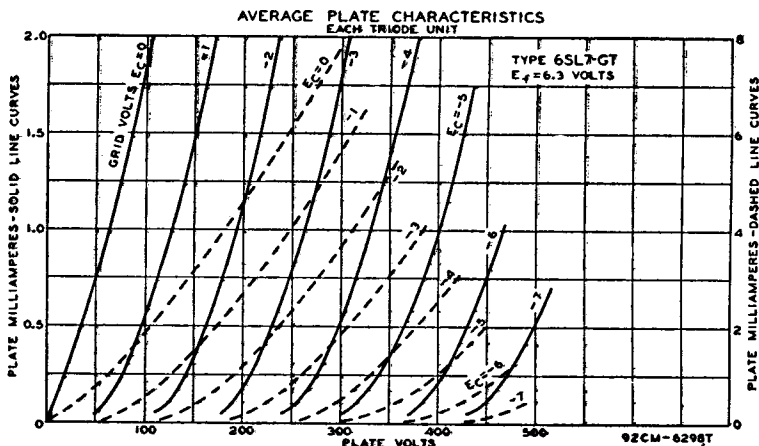



### Characteristics:

Plate Voltage .....	250	volts
Grid Voltage .....	-2	volts
Amplification Factor .....	70	
Plate Resistance .....	44000	ohms
Transconductance .....	1600	ohms
Plate Current .....	2.3	ma

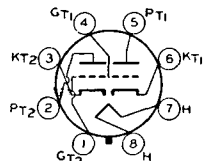

## MEDIUM-MU TWIN TRIODE

Glass octal types used as combined vertical oscillators and vertical deflection amplifiers, and as horizontal deflection oscillators, in television receivers. Also used as phase inverters,

## 6SN7-GT 6SN7-GTA 6SN7-GTB

multivibrators, or resistance-coupled amplifiers in radio equipment. Type 6SN7-GTB has a controlled heater warm-up time to permit use in series-connected heater strings. Outline 22, OUTLINES SECTION. Tubes require octal socket and may be mounted in any position. Except for the common heater, each triode unit is independent of the other. For typical operation as phase inverter or resistance-coupled amplifier, refer to Chart 13, RESISTANCE-COUPLED AMPLIFIER SECTION. For heater and cathode considerations, refer to type 6AQ5. Types 6SN7-GT and 6SN7-GTA are DISCONTINUED types listed for reference only.

HEATER VOLTAGE (AC/DC) .....	6.3	volts
HEATER CURRENT .....	0.6	ampere
HEATER-WARM-UP TIME (Average)* for 6SN7-GTB .....	11	seconds

DIRECT INTERELECTRODE CAPACITANCES (Approx.) for 6SN7-GTB:

	Unit No.1	Unit No.2	
Grid to Plate .....	4.0	3.8	$\mu\text{f}$
Grid to Cathode and Heater .....	2.2	2.6	$\mu\text{f}$
Plate to Cathode and Heater .....	0.7	0.7	$\mu\text{f}$

\* For definition of heater warm-up time and method for determining it, see type 6CG7.

### CLASS A<sub>1</sub> AMPLIFIER (Each Unit)

Maximum Ratings:	6SN7-GTB	
PLATE VOLTAGE .....	450 max	volts
CATHODE CURRENT .....	20 max	ma
PLATE DISSIPATION:		
For either plate .....	5 max	watts
For both plates with both units operating .....	7.5 max	watts
PEAK HEATER-CATHODE VOLTAGE:		
Heater negative with respect to cathode .....	200 max	volts
Heater positive with respect to cathode .....	200 <sup>o</sup> max	volts

AVERAGE PLATE CHARACTERISTICS  
EACH TRIODE UNIT

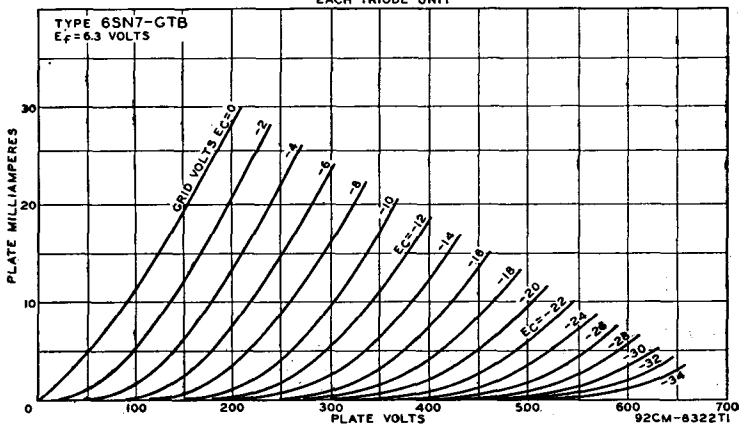

### Characteristics:

Plate Voltage.....	90	250	volts
Grid Voltage.....	0	-8	volts
Amplification Factor.....	20	20	
Plate Resistance.....	6700	7700	ohms
Transconductance.....	3000	2600	μmhos
Plate Current.....	10	9	ma
Plate Current for grid voltage of -12.5 volts.....	-	1.3	ma
Grid Voltage (Approx.) for plate current of 10 μa.....	-7	-18	volts

### Maximum Circuit Value:

Grid-Circuit Resistance:	
For fixed-bias operation.....	1.0 max megohm

° The dc component must not exceed 100 volts.

### OSCILLATOR

*For operation in a 525-line, 30-frame system*

	6SN7-GTB		
	Vertical Deflection Oscillator	Horizontal Deflection Oscillator	
<b>Maximum Ratings (Each Unit):</b>			
DC PLATE VOLTAGE.....	450 max	450 max	volts
PEAK NEGATIVE-PULSE GRID VOLTAGE.....	-400 max	-600 max	volts
<b>CATHODE CURRENT:</b>			
Peak.....	70 max	300 max	ma
Average.....	20 max	20 max	ma
<b>PLATE DISSIPATION:</b>			
For either plate.....	5 max	5 max	watts
For both plates with both units operating.....	7.5 max	7.5 max	watts
<b>PEAK HEATER-CATHODE VOLTAGE:</b>			
Heater negative with respect to cathode.....	200 max	200 max	volts
Heater positive with respect to cathode.....	200°max	200°max	volts

### Maximum Circuit Value:

Grid-Circuit Resistance.....	2.2 max	2.2 max megohms
------------------------------	---------	-----------------

### VERTICAL DEFLECTION AMPLIFIER

*For operation in a 525-line, 30-frame system*

	6SN7-GTB		
<b>Maximum Ratings (Each Unit):</b>			
DC PLATE VOLTAGE.....	450 max	450 max	volts
PEAK POSITIVE-PULSE PLATE VOLTAGE # (Absolute maximum).....	1500°max		volts
PEAK NEGATIVE-PULSE GRID VOLTAGE.....	-250 max		volts
<b>CATHODE CURRENT:</b>			
Peak.....	70 max		ma
Average.....	20 max		ma
<b>PLATE DISSIPATION:</b>			
For either plate.....	5 max		watts
For both plates with both units operating.....	7.5 max		watts
<b>PEAK HEATER-CATHODE VOLTAGE:</b>			
Heater negative with respect to cathode.....	200 max		volts
Heater positive with respect to cathode.....	200°max		volts

### Maximum Circuit Value:

Grid-Circuit Resistance:	
For cathode-bias operation.....	2.2 max megohms

# The duration of the voltage pulse must not exceed 15 per cent of one vertical scanning cycle. In a 525-line, 30-frame system, 15 per cent of one vertical scanning cycle is 2.5 milliseconds.

■ Under no circumstances should this absolute value be exceeded.

° The dc component must not exceed 100 volts.

## TWIN DIODE—HIGH-MU TRIODE

Metal type 6SQ7 and glass-octal type 6SQ7-GT used as combined detector, amplifier, and avc tube in radio receivers. These types are similar electrically to type 6Q7 in many respects, but they have a higher-mu triode. Type 6SQ7-GT is used principally for renewal purposes.

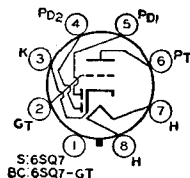

# 6SQ7 6SQ7-GT

# RCA Receiving Tube Manual

HEATER VOLTAGE (AC/DC).....	6.8	volts
HEATER CURRENT.....	0.3	ampere
<b>DIRECT INTERELECTRODE CAPACITANCES (Approx.):</b>		
Triode Unit:	<i>6SQ7<sup>o</sup></i>	<i>6SQ7-GT</i>
Grid to Plate.....	1.6	1.8 <span style="float: right;"><math>\mu</math>f</span>
Grid to Cathode and Heater.....	3.2	4.2 <span style="float: right;"><math>\mu</math>f</span>
Plate to Cathode and Heater.....	3.0	3.4 <span style="float: right;"><math>\mu</math>f</span>
Diode Plate to Cathode and Heater.....	0.4	1.8 <span style="float: right;"><math>\mu</math>f</span>
Triode Grid to Plate of Diode No. 1.....	0.03	0.1 <i>max</i> <span style="float: right;"><math>\mu</math>f</span>

<sup>o</sup> With shell connected to cathode.

## Maximum Ratings:

### TRIODE UNIT AS CLASS A<sub>1</sub> AMPLIFIER

PLATE VOLTAGE.....	300 <i>max</i>	volts
GRID VOLTAGE, Positive Bias Value.....	0 <i>max</i>	volts
PLATE DISSIPATION.....	0.5 <i>max</i>	watt
<b>PEAK HEATER-CATHODE VOLTAGE:</b>		
Heater negative with respect to cathode.....	90 <i>max</i>	volts
Heater positive with respect to cathode.....	90 <i>max</i>	volts

## Characteristics:

Plate Voltage.....	100	250	volts
Grid Voltage.....	-1	-2	volts
Amplification Factor.....	100	100	
Plate Resistance.....	110000	85000	ohms
Transconductance.....	925	1175	$\mu$ mhos
Plate Current.....	0.5	1.1	ma

## Maximum Rating:

### DIODE UNITS

PLATE CURRENT (Each Unit).....	1.0 <i>max</i>	ma
--------------------------------	----------------	----

Two diode plates are placed around a cathode, the sleeve of which is common to the triode unit. Each diode plate has its own base pin. For diode operation curves, refer to type 6AV6.

## INSTALLATION AND APPLICATION

Types 6SQ7 and 6SQ7-GT require octal socket and may be mounted in any position. Outlines 3 and 25, respectively, **OUTLINES SECTION**. For heater and cathode considerations, refer to type 6AV6.

The triode unit of the 6SQ7 and 6SQ7-GT is recommended for use only in resistance-coupled circuits; refer to Chart 4, **RESISTANCE-COUPLED AMPLIFIER SECTION**. Diode-biasing of the triode unit is not suitable because of the probability of triode plate-current cutoff even with relatively small signal voltages applied to the diode circuit.

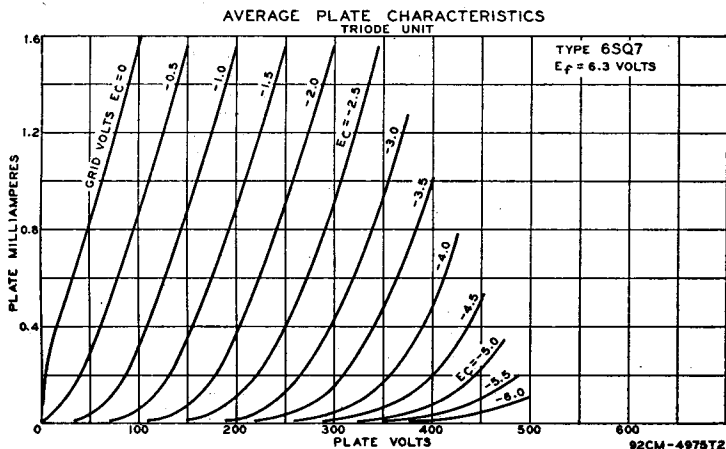

### TWIN DIODE— MEDIUM-MU TRIODE

**6SR7**

Metal type used as combined detector, amplifier, and avc tube. It is equivalent in performance to miniature type 6BF6. Outline 3, OUTLINES SECTION. Tube requires octal socket and may be mounted in any position. For typical operation as a resistance-coupled amplifier, refer to Chart 9, RESISTANCE-COUPLED AMPLIFIER SECTION. Heater volts (ac/dc), 6.3; amperes, 0.3. Maximum ratings and typical

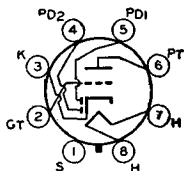

operation of triode unit as class A<sub>1</sub> amplifier: plate volts, 250 *max*; grid volts, -9; amplification factor, 16; plate resistance, 8500 ohms; transconductance, 1900  $\mu$ mhos; plate ma., 9.5; plate dissipation, 2.5 *max* watts; load resistance, 10000 ohms; power output, 300 milliwatts; peak heater-cathode volts, 90 *max*. For diode-operation curves, refer to type 6AV6. For heater and cathode considerations, refer to type 6AV6. Type 6SR7 is used principally for renewal purposes.

### REMOTE-CUTOFF PENTODE

**6SS7**

Metal type used in rf or if stages of radio receivers particularly those employing avc. Outline 3, OUTLINES SECTION. Tube requires octal socket and may be mounted in any position. For heater and cathode considerations, refer to type 6AV6. Heater volts (ac/dc), 6.3; amperes, 0.15. Typical operation and maximum ratings as class A<sub>1</sub> amplifier: plate volts, 250 (300 *max*), grid-No.2 supply volts, 300 *max*;

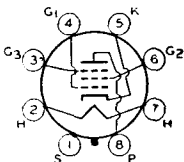

grid-No.2 volts, 100; grid-No.1 volts, -3; grid No.3 connected to cathode at socket; plate resistance (approx.), 1 megohm; transconductance, 1850  $\mu$ mhos; plate ma., 9; grid-No.2 ma., 2; plate dissipation, 2.25 *max* watts; grid-No.2 input, 0.35 *max* watts. Type 6SS7 is used principally for renewal purposes.

### TWIN DIODE—MEDIUM-MU TRIODE

**6ST7**

Metal type used as combined detector, amplifier, and avc tube. Within maximum ratings this type is electrically identical to type 6BF6 except for interelectrode capacitances and heater current. Outline 3, OUTLINES SECTION. Tube requires octal socket and may be mounted in any position. Heater volts (ac/dc), 6.3; amperes, 0.15. Maximum ratings of triode

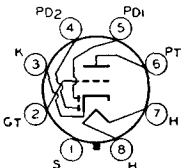

unit as class A<sub>1</sub> amplifier: plate volts, 250 *max*; plate dissipation, 2.5 *max* watts. For diode operation curves, refer to type 6AV6. Type 6ST7 is a DISCONTINUED type listed for reference only.

### TWIN DIODE—HIGH-MU TRIODE

**6SZ7**

Metal type used as combined detector, amplifier, and avc tube in radio receivers. Except for heater-current rating and interelectrode capacitances, this type is essentially the same electrically as type 6AT6. Outline 3, OUTLINES SECTION. Tube requires octal socket and may be mounted in any position. Heater volts (ac/dc), 6.3; amperes, 0.15. Direct interelectrode capacitances of triode unit (shell connected to cathode):

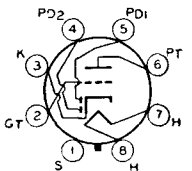

grid to plate, 1.1  $\mu$ f; input, 2.4  $\mu$ f; output, 2.8  $\mu$ f. For diode operation curves, refer to type 6AV6. Type 6SZ7 is used principally for renewal purposes.

### MEDIUM-MU TRIODE

**6T4**

Miniature type used as oscillator in tuners of uhf television receivers. Outline 9, OUTLINES SECTION. Tube requires miniature seven-contact socket and may be mounted in any position.

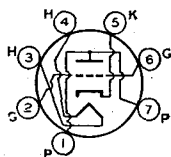

# RCA Receiving Tube Manual

HEATER VOLTAGE (AC/DC) .....	6.3	volts
HEATER CURRENT .....	0.225	ampere

DIRECT INTERELECTRODE CAPACITANCES (Approx.)			
	<i>Without External Shield</i>	<i>With External Shield<sup>o</sup></i>	
Grid to plate .....	1.7	1.7	$\mu\text{f}$
Grid to cathode and heater .....	2.6	3.2	$\mu\text{f}$
Plate to cathode and heater .....	9.4	2.0	$\mu\text{f}$
Heater to cathode .....	3.0	3.0 <sup>o</sup>	$\mu\text{f}$
Grid to cathode .....	2.4	2.4 <sup>*</sup>	$\mu\text{f}$
Plate to cathode .....	0.24	0.22	$\mu\text{f}$
AMPLIFICATION FACTOR* .....		13	
TRANSCONDUCTANCE* .....		7000	$\mu\text{mhos}$

- \* For plate-supply volts, 80; cathode-bias resistor, 150 ohms; plate ma., 18.
- <sup>o</sup> External shield connected to cathode, except as noted.
- <sup>\*</sup> External shield connected to ground.

## OSCILLATOR IN UHF TELEVISION RECEIVERS

### Maximum Ratings:

PLATE VOLTAGE .....	200 max	volts
GRID CURRENT .....	8 max	ma
CATHODE CURRENT .....	30 max	ma
PLATE DISSIPATION .....	3.5 max	watts
<b>PEAK HEATER-CATHODE VOLTAGE:</b>		
Heater negative with respect to cathode .....	50 max	volts
Heater positive with respect to cathode .....	50 <sup>a</sup> max	volts

<sup>a</sup> The dc component must not exceed 25 volts.

### TWIN DIODE—HIGH-MU TRIODE

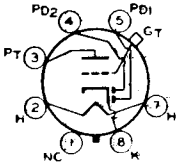

Glass octal type used as combined detector, amplifier, and avc tube in radio receivers. Outline 38, OUTLINES SECTION. For heater and cathode considerations, refer to type 6AV6. Heater volts (ac/dc), 6.3; amperes, 0.15. Typical operation as class A<sub>1</sub> amplifier: plate volts, 250 max; grid volts, -3; plate ma., 1.2; plate resistance, 62000 ohms; amplification factor,

# 6T7-G

65; transconductance, 1050  $\mu\text{mhos}$ . For diode operation curves, refer to type 6AV6. Type 6T7-G is a DISCONTINUED type listed for reference only.

### TRIPLE DIODE—HIGH-MU TRIODE

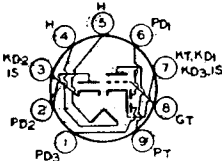

Miniature type used as combined audio amplifier, AM detector, and FM detector in AM/FM radio receivers. Diode unit No.1 is used for AM detection, and diode units No.2 and No.3

# 6T8

are used for FM detection. Outline 12, OUTLINES SECTION. Tube requires miniature nine-contact socket and may be mounted in any position. For typical operation as a resistance-coupled amplifier, refer to Chart 7, RESISTANCE-COUPLED AMPLIFIER SECTION. For heater and cathode considerations, refer to type 6AQ5.

HEATER VOLTAGE (AC/DC) .....	6.3	volts
HEATER CURRENT .....	0.45	ampere
DIRECT INTERELECTRODE CAPACITANCES (Approx.):		
Triode Grid to Triode Plate .....	1.8	$\mu\text{f}$
Triode Grid to Cathode, Heater, and Internal Shield .....	1.6	$\mu\text{f}$
Triode Plate to Cathode, Heater, and Internal Shield .....	1.1	$\mu\text{f}$
Diode-No.1 Plate to Cathode, Heater, and Internal Shield .....	3.8	$\mu\text{f}$
Diode-No.2 Plate to Cathode, Heater, and Internal Shield .....	4.5	$\mu\text{f}$
Diode-No.3 Plate to Cathode, Heater, and Internal Shield .....	3.8	$\mu\text{f}$
Diode-No.2 Cathode and Internal Shield to All Other Electrodes .....	8.5	$\mu\text{f}$
Triode Grid to Any Diode Plate .....	0.035 max	$\mu\text{f}$

## TRIODE UNIT AS CLASS A<sub>1</sub> AMPLIFIER

### Maximum Ratings:

PLATE VOLTAGE.....	800 <i>max</i>	volts
GRID VOLTAGE, Positive Bias Value.....	0 <i>max</i>	volts
PLATE DISSIPATION.....	1 <i>max</i>	watt
<b>PEAK HEATER-CATHODE VOLTAGE:</b>		
Heater negative with respect to cathode.....	90 <i>max</i>	volts
Heater positive with respect to cathode.....	90 <i>max</i>	volts

### Characteristics:

Plate Voltage.....	100	250	volts
Grid Voltage.....	-1	-3	volts
Amplification Factor.....	70	70	
Plate Resistance.....	54000	58000	ohms
Transconductance.....	1300	1200	$\mu$ mhos
Plate Current.....	0.8	1.0	ma

## DIODE UNITS

### Maximum Rating:

PLATE CURRENT (Each Unit).....	5 <i>max</i>	ma
--------------------------------	--------------	----

Diode units No.1 and No.3 have a common cathode. Diode unit No.2 has a separate cathode.

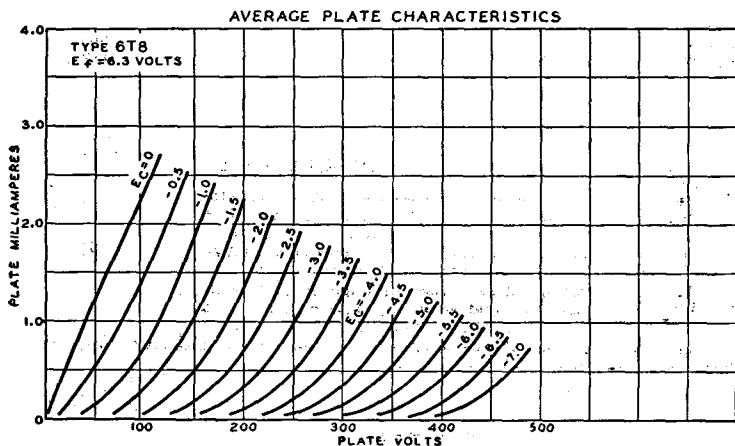

## ELECTRON-RAY TUBE

Glass type used to indicate visually, by means of a fluorescent target, the effects of a change in a controlling voltage. It is used as a convenient, non-mechanical means of indicating accurate radio-receiver tuning. Outline 34, OUTLINES SECTION. Tube requires six-contact socket and may be mounted in any position. For heater and cathode considerations,

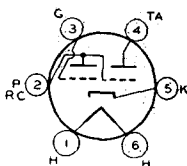

## 6U5

refer to type 6AV6. Type 6U5 has a remote plate-current cutoff characteristic. For a discussion of electron-ray tube considerations, refer to ELECTRON TUBE APPLICATIONS SECTION. Heater volts (ac/dc), 6.3; amperes, 0.3. Maximum ratings for indicator service: plate-supply volts, 285 *max*; target volts, 285 *max*, 125 *min*; plate dissipation, 1.0 *max* watt; peak heater-cathode volts, 90 *max*. This type is used principally for renewal purposes.

### Typical Operation:

### INDICATOR SERVICE

Plate- and Target-Supply Voltage.....	200	250	volts
Series Triode-Plate Resistor.....	1	1	megohm
Target Current (For zero grid voltage).....	3.0	4.0	ma
Triode Plate Current (For zero grid voltage).....	0.19	0.24	ma
Triode Grid Voltage (Approx. for 0° shadow angle).....	-18.5	-22	volts
Triode Grid Voltage (Approx. for 90° shadow angle).....	0	0	volts

**REMOTE-CUTOFF PENTODE**

Glass octal type used in rf and if stages of radio receivers employing avc. It is also used as a mixer in superheterodyne circuits. Maximum over-all length, 4-7/8 inches; maximum diameter, 1-9/16 inches. Tube requires octal socket. Refer to type 6SK7 for general application information. Heater volts (ac/dc), 6.3; amperes, 0.3. Typical operation and maximum ratings as class A<sub>1</sub> amplifier: plate volts, 250

**6U7-G**

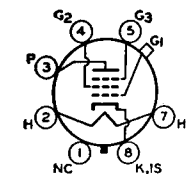

(300 *max*); grid-No.2 supply volts, 300 *max*; grid-No.2 volts, 100; grid No.3 connected to cathode at socket; grid-No.1 volts, -3; plate resistance (approx.), 0.8 megohm; transconductance, 1600  $\mu$ mhos; plate ma., 8.2; grid-No.2 ma., 2; plate dissipation, 2.25 *max* watts; grid-No.2 input, 0.25 *max* watt. This is a **DISCONTINUED** type listed for reference only.

**TRIODE—PENTODE CONVERTER**

Miniature types used as combined oscillator and mixer tubes in television receivers utilizing an intermediate frequency in the order of 40 megacycles per second. In such service, these types

**6U8  
6U8-A**

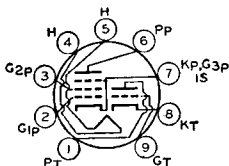

give performance comparable to that obtainable with a 6AG5 mixer and an oscillator consisting of one unit of a type 6J6. When used in an AM/FM receiver, the triode unit is used as an oscillator for both sections. In the AM section, the pentode unit is used as a high-gain pentode mixer; in the FM section, the pentode unit is used either as a pentode mixer or as a triode-connected mixer depending on signal-to-noise consideration. Type 6U8-A has a controlled heater warm-up time for use in television receivers employing series-connected heater strings. Outline 12, **OUTLINES SECTION**. Tubes require miniature nine-contact socket and may be mounted in any position.

HEATER VOLTAGE.....	6.3	volts
HEATER CURRENT.....	0.45	ampere
HEATER WARM-UP TIME (Average)* for 6U8-A.....	11	seconds

DIRECT INTERELECTRODE CAPACITANCES:		<i>Without External Shield</i>	<i>With External Shield</i>	
<b>Triode Unit:</b>				
Grid to Plate.....	1.8	1.8		$\mu$ f
Grid to Cathode and Heater.....	2.5	2.5		$\mu$ f
Plate to Cathode and Heater.....	0.4	1.0		$\mu$ f
<b>Pentode Unit:</b>				
Grid No.1 to Plate.....	0.010 <i>max</i>	0.006 <i>max</i>		$\mu$ f
Grid No.1 to Cathode, Heater, Grid No.2, Grid No.3, and Internal Shield.....	5.0	5.0		$\mu$ f
Plate to Cathode, Heater, Grid No.2, Grid No.3, and Internal Shield.....	2.6	3.5		
Heater to Cathode (Approx., Each Unit).....	3.0	3.0		$\mu$ f

\* For definition of heater warm-up time and method for determining it, see type 6CG7

Characteristics:		<i>Triode Unit</i>	<i>Pentode Unit</i>	
Plate Supply Voltage.....	150	250		volts
Grid-No.2 Supply Voltage.....	-	110		volts
Cathode-Bias Resistor.....	56	68		ohms
Amplification Factor.....	40	-		
Plate Resistance (Approx.).....	5000	40000		ohms
Transconductance.....	8500	5200		$\mu$ mhos
Grid-No.1 Voltage for plate current of 10 $\mu$ a.....	-12	-10		volts
Plate Current.....	18	10		ma
Grid-No.2 Current.....	-	3.5		ma

**CONVERTER SERVICE**

Maximum Ratings:		<i>Triode Unit</i>	<i>Pentode Unit</i>	
PLATE VOLTAGE.....	300 <i>max</i>	300 <i>max</i>		volts
GRID-NO.2 (SCREEN-GRID) SUPPLY VOLTAGE.....	-	300 <i>max</i>		volts
GRID-NO.2 VOLTAGE.....	-	See curve page 67		
<b>GRID-NO.1 (CONTROL-GRID) VOLTAGE:</b>				
Positive bias value.....	0 <i>max</i>	0 <i>max</i>		volts
PLATE DISSIPATION.....	2.7 <i>max</i>	2.8 <i>max</i>		watts
<b>GRID-NO.2 INPUT:</b>				
For grid-No.2 voltages up to 150 volts.....	-	0.5 <i>max</i>		watt
For grid-No.2 voltages between 150 and 300 volts.....	-	See curve page 67		

**PEAK HEATER-CATHODE VOLTAGE:**

Heater negative with respect to cathode.....	200† max	200† max	volts
Heater positive with respect to cathode.....	200‡ max	200‡ max	volts

‡ The dc component must not exceed 100 volts.

† For type 6U8-A. Peak heater-cathode volts for type 6U8, 90 max.

### AVERAGE PLATE CHARACTERISTICS PENTODE UNIT

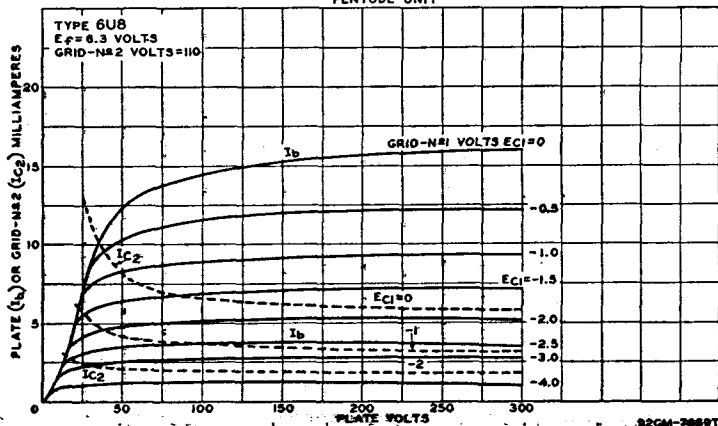

### AVERAGE PLATE CHARACTERISTICS TRIODE UNIT OR PENTODE UNIT CONNECTED AS TRIODE

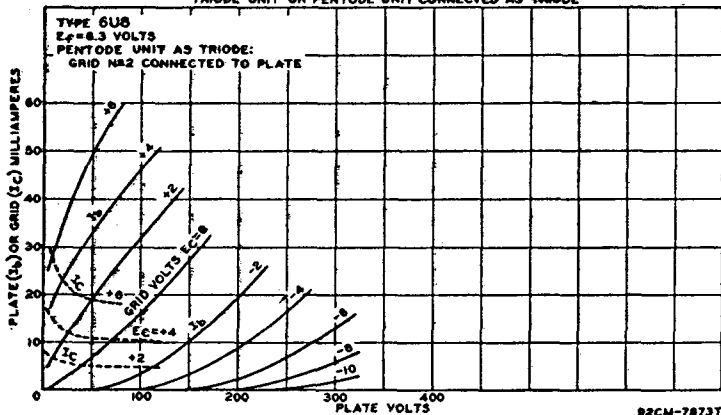

## HALF-WAVE VACUUM RECTIFIER

# 6V3-A

Miniature type used as a damper tube in horizontal deflection circuits of television receivers. Outline 19, OUTLINES SECTION. Tube requires

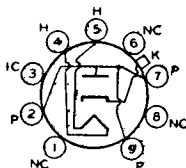

miniature nine-contact socket and may be mounted in any position. It is especially important that this tube, like other power-handling tubes, be adequately ventilated.

HEATER VOLTAGE (AC/DC).....	6.3	volts
HEATER CURRENT.....	1.75	amperes

#### DAMPER SERVICE

For operation in a 525-line, 30-frame system		
Maximum Ratings:		
PEAK INVERSE PLATE VOLTAGE# (Absolute Maximum).....	6000‡ max	volts
PEAK PLATE CURRENT.....	800 max	ma
DC PLATE CURRENT.....	135 max	ma



**PEAK HEATER-CATHODE VOLTAGE:**

Heater negative with respect to cathode# (Absolute Maximum).....	6750 <sup>†</sup> max	volts
Heater positive with respect to cathode.....	300° max	volts

# The duration of the voltage pulse must not exceed 15 per cent of one horizontal scanning cycle. In a 525-line, 30-frame system, 15 per cent of one horizontal scanning cycle is 10 microseconds.

† Under no circumstances should this absolute value be exceeded.

• The dc component must not exceed 750 volts.

° The dc component must not exceed 100 volts.

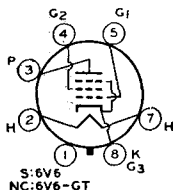

## BEAM POWER TUBE

Metal type 6V6 and glass-octal type 6V6-GT are used as output amplifiers in automobile, battery-operated, and other receivers in which reduced plate-current drain is desirable. Out-

# 6V6 6V6-GT

lines 6 and 23, respectively, OUTLINES SECTION. Type 6V6-GT may be supplied with pin No.1 omitted. Tubes require octal socket and may be mounted in any position. The 6V6 and 6V6-GT are equivalent in performance to type 6AQ5. Refer to type 6AQ5 for heater and cathode considerations, application information, and characteristic curves.

HEATER VOLTAGE (AC/DC).....	6.3	volts
HEATER CURRENT.....	0.45	ampere
<b>DIRECT INTERELECTRODE CAPACITANCES (Approx.):</b>		
6V6°	6V6-GT	
Grid No.1 to Plate.....	0.3	0.7
Grid No.1 to Cathode, Heater, Grid No.2, and Grid No.3....	10	9.0
Plate to Cathode, Heater, Grid No.2, and Grid No.3.....	11	7.5

° With shell connected to cathode.

### Maximum Ratings: SINGLE-TUBE CLASS A<sub>1</sub> AMPLIFIER

PLATE VOLTAGE.....	315 max	volts
GRID-NO.2 (SCREEN-GRID) VOLTAGE.....	285 max	volts
PLATE DISSIPATION.....	12 max	watts
GRID-NO.2 INPUT.....	2 max	watts
<b>PEAK HEATER-CATHODE VOLTAGE:</b>		
Heater negative with respect to cathode.....	90 max	volts
Heater positive with respect to cathode.....	90 max	volts

### Typical Operation:

Plate Voltage.....	180	250	315	
Grid-No.2 Voltage.....	180	250	225	volts
Grid-No.1 (Control-Grid) Voltage.....	-8.5	-12.5	-13	volts
Peak AF Grid-No.1 Voltage.....	8.5	12.5	13	volts
Zero-Signal Plate Current.....	29	45	34	ma
Maximum-Signal Plate Current.....	30	47	35	ma
Zero-Signal Grid-No.2 Current (Approx.).....	3	4.5	2.2	ma
Maximum-Signal Grid-No.2 Current (Approx.).....	4	7	6	ma
Plate Resistance.....	50000	50000	80000	ohms
Transconductance.....	3700	4100	3750	μmhos
Load Resistance.....	5500	5000	8500	ohms
Total Harmonic Distortion.....	8	8	12	per cent
Maximum-Signal Power Output.....	2	4.5	5.5	watts

### Maximum Ratings: PUSH-PULL CLASS AB<sub>1</sub> AMPLIFIER

(Same as for single-tube class A<sub>1</sub> amplifier)

#### Typical Operation (Values are for two tubes):

Plate Voltage.....	250	285	285	
Grid-No.2 Voltage.....	250	250	285	volts
Grid-No.1 (Control-Grid) Voltage.....	-15	-19	-19	volts
Peak AF Grid-No.1-to-Grid-No.1 Voltage.....	30	38	38	volts
Zero-Signal Plate Current.....	70	70	70	ma
Maximum-Signal Plate Current.....	79	92	92	ma
Zero-Signal Grid-No.2 Current (Approx.).....	5	4	4	ma
Maximum-Signal Grid-No.2 Current (Approx.).....	13	13.5	13.5	ma
Plate Resistance (Approx.).....	60000	70000	70000	ohms
Transconductance.....	3750	3600	3600	μmhos
Effective Load Resistance.....	10000	8000	8000	ohms
Total Harmonic Distortion.....	5	3.5	3.5	per cent
Maximum-Signal Power Output.....	10	14	14	watts

## Maximum Circuit Values:

Grid-No.1-Circuit Resistance:

For fixed-bias operation .....	0.1 max	megohm
For cathode-bias operation .....	0.5 max	megohm

## TWIN DIODE—MEDIUM-MU TRIODE

Glass octal type used as combined detector, amplifier, and avc tube. Outline 38, OUTLINES SECTION. Except for interelectrode capacitances, this type is identical electrically with type 85. Heater volts (ac/dc), 6.3; amperes, 0.3. For diode operation curves, refer to type 6AV6. Type 6V7-G is a DISCONTINUED type listed for reference only.

### 6V7-G

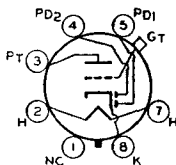

## HALF-WAVE VACUUM RECTIFIER

Glass octal type used as damper diode in magnetic deflection circuit of television receivers and as a rectifier in conventional power-supply applications. Outline 23, OUTLINES SECTION. This type may be supplied with pin No.1 omitted. Tube requires octal socket and may be mounted in any position. It is especially important that this tube, like other power-handling tubes, be adequately ventilated. For curve of average plate characteristics, see page 64.

### 6W4-GT

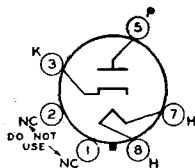

TION. This type may be supplied with pin No.1 omitted. Tube requires octal socket and may be mounted in any position. It is especially important that this tube, like other power-handling tubes, be adequately ventilated. For curve of average plate characteristics, see page 64.

HEATER VOLTAGE (AC) .....	6.3	volts
HEATER CURRENT .....	1.2	amperes

## DAMPER SERVICE

Maximum Ratings: *For operation in a 525-line, 30-frame system*

PEAK INVERSE PLATE VOLTAGE*	3500 max	volts
PEAK PLATE CURRENT .....	600 max	ma
DC PLATE CURRENT .....	125 max	ma
PEAK HEATER-CATHODE VOLTAGE:		
Heater negative with respect to cathode*	2100 max	volts
Heater positive with respect to cathode .....	100 max	volts

\* The duration of the voltage pulse must not exceed 15 per cent of one horizontal scanning cycle. In a 525-line, 30-frame system, 15 per cent of one horizontal scanning cycle is 10 microseconds.

## RECTIFIER SERVICE

PEAK INVERSE PLATE VOLTAGE .....	1250 max	volts
PEAK PLATE CURRENT .....	600 max	ma
HOT-SWITCHING TRANSIENT PLATE CURRENT (For duration of 0.2 second max)	3.5 max	amperes
DC OUTPUT CURRENT .....	125 max	ma
PEAK HEATER-CATHODE VOLTAGE:		
Heater negative with respect to cathode .....	450 max	volts
Heater positive with respect to cathode .....	100 max	volts

## Typical Operation (Capacitor-Input Filter):

	Half-Wave Rectifier (One Tube)	Full-Wave Rectifier (Two Tubes)	
AC Plate-to-Plate Supply Voltage (rms) .....	—	700	volts
AC Plate-Supply Voltage (rms) .....	350	—	volts
Filter-Input Capacitor .....	20	20	$\mu$ f
Minimum Total Effective Plate-Supply Impedance per Plate .....	145	145	ohms
DC Output Current .....	125	250	ma
DC Output Voltage at Input to Filter (Approx.):			
At half-load current of { 62.5 ma .....	390	—	volts
{ 125 ma .....	—	395	volts
At full-load current of { 125 ma .....	335	—	volts
{ 250 ma .....	—	350	volts
Voltage Regulation (Approx.):			
Half-load to full-load current .....	55	45	volts

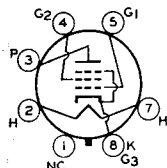

## BEAM POWER TUBE

Glass octal type used in the audio output stage of radio and television receivers. Triode-connected, it is used as a vertical deflection amplifier in television receivers. Outline 22 or 23,

# 6W6-GT

**OUTLINES SECTION.** This type may be supplied with pin No.1 omitted. Tube requires octal socket and may be mounted in any position.

HEATER VOLTAGE (AC/DC) .....	6.3	volts
HEATER CURRENT .....	1.2	amperes
<b>DIRECT INTERELECTRODE CAPACITANCES:</b>		
Grid No.1 to Plate .....	0.5	$\mu$ f
Grid No.1 to Cathode, Heater, Grid No.2, and Grid No.3 .....	15.0	$\mu$ f
Plate to Cathode, Heater, Grid No.2, and Grid No.3 .....	9.0	$\mu$ f

**Maximum Ratings:**

### CLASS A<sub>1</sub> AMPLIFIER

DC PLATE VOLTAGE .....	300 <i>max</i>	volts
GRID-NO.2 (SCREEN-GRID) VOLTAGE .....	150 <i>max</i>	volts
PLATE DISSIPATION .....	10 <i>max</i>	watts
GRID-NO.2 INPUT .....	1.25 <i>max</i>	watts
<b>PEAK HEATER-CATHODE VOLTAGE:</b>		
Heater negative with respect to cathode .....	200 <i>max</i>	volts
Heater positive with respect to cathode .....	200 <i>max</i>	volts

■ The dc component must not exceed 100 volts.

**Typical Operation:**

Plate Supply Voltage .....	110	200	volts
Grid-No.2 Supply Voltage .....	110	125	volts
Grid-No.1 (Control-Grid) Voltage .....	-7.5	—	volts
Cathode-Bias Resistor .....	—	180	ohms
Peak AF Grid-No.1 Voltage .....	7.5	8.5	volts
Zero-Signal Plate Current .....	49	46	ma
Maximum-Signal Plate Current .....	50	47	ma
Zero-Signal Grid-No.2 Current .....	4	2.2	ma
Maximum-Signal Grid-No.2 Current .....	10	8.5	ma
Plate Resistance (Approx.) .....	13000	28000	ohms
Transconductance .....	8000	8000	$\mu$ mhos
Plate Load Resistance .....	2000	4000	ohms
Total Harmonic Distortion (Approx.) .....	10	10	per cent
Maximum-Signal Power Output .....	2.1	3.8	watts

**Maximum Circuit Values (For maximum rated conditions):**

Grid-No.1 Circuit Resistance:		
For fixed-bias operation .....	0.1 <i>max</i>	megohm
For cathode-bias operation .....	0.5 <i>max</i>	megohm

**AVERAGE PLATE CHARACTERISTICS**  
PENTODE CONNECTION

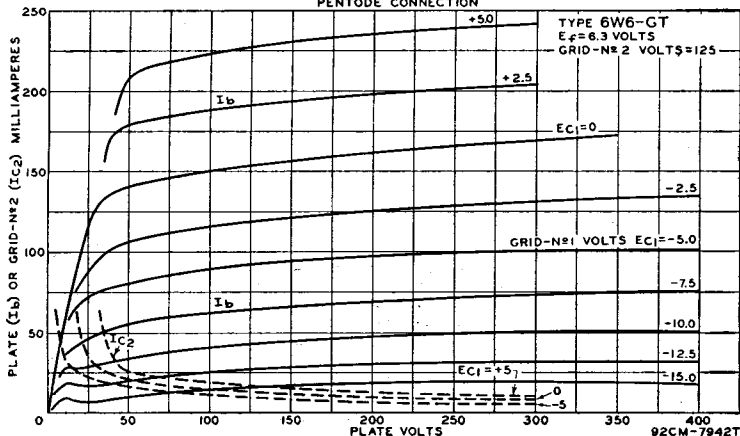

## Characteristics (Triode Connection)\*:

Plate Voltage.....	225	volts
Grid-No.1 Voltage.....	-30	volts
Amplification Factor.....	6.2	
Plate Resistance.....	1600	ohms
Transconductance.....	3800	$\mu$ mhos
Plate Current.....	22	ma
Grid-No.1 Voltage (Approx.) for plate current of 50 $\mu$ a.....	-42	volts

\*Grid-No. 2 connected to plate.

## VERTICAL DEFLECTION AMPLIFIER (Triode Connection)\*

*For operation in a 525-line, 30-frame system*

### Maximum Ratings:

DC PLATE VOLTAGE.....	300 max	volts
PEAK POSITIVE-PULSE PLATE VOLTAGE† (Absolute maximum).....	1200°max	volts
PEAK NEGATIVE-PULSE GRID-NO.1 VOLTAGE.....	-250 max	volts
<b>CATHODE CURRENT:</b>		
Peak.....	140 max	ma
Average.....	40 max	ma
PLATE DISSIPATION.....	7.5 max	watts
<b>PEAK HEATER-CATHODE VOLTAGE:</b>		
Heater negative with respect to cathode.....	200 max	volts
Heater positive with respect to cathode.....	200°max	volts

### Maximum Circuit Value:

Grid-No.1-Circuit Resistance: For cathode-bias operation.....	2.2 max	megohms
--	---------	---------

\* Grid No.2 connected to plate.

† The duration of the voltage pulse must not exceed 15 per cent of one vertical scanning cycle. In a 525-line, 30-frame system, 15 per cent of one vertical scanning cycle is 2.5 milliseconds.

° Under no circumstances should this absolute value be exceeded.

■ The dc component must not exceed 100 volts.

### AVERAGE PLATE CHARACTERISTICS TRIODE CONNECTION

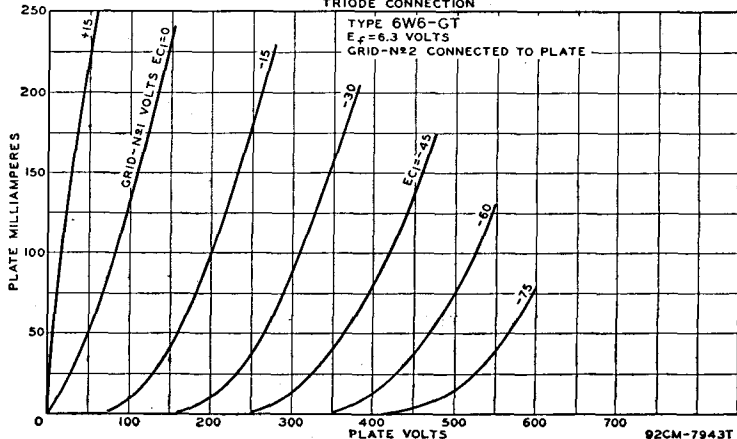

### SHARP-CUTOFF PENTODE

Glass octal type used as biased detector or high-gain amplifier in radio receivers. Outline 38, OUTLINES SECTION. Tube requires octal socket. Heater volts (ac/dc), 6.3; amperes, 0.15. Maximum ratings: plate volts, 300 max; grid-No.2 (screen-grid) volts, 100 max; grid-No.2 supply volts, 300 max; grid-No.1 (control-grid) volts, 0 min; plate dissipation, 0.5 max

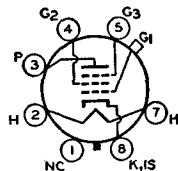

## 6W7-G

watt; grid-No.2 input, 0.1 max watt. Within its maximum ratings, this type is identical electrically with type 6J7. Type 6W7-G is a DISCONTINUED type listed for reference only.

**FULL-WAVE VACUUM RECTIFIER**

**6X4**

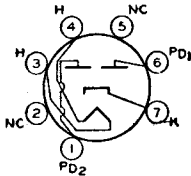

Miniature type used in power supply of automobile and ac-operated radio receivers. Equivalent in performance to larger types 6X5 and 6X5-GT. Type 6X4 requires miniature seven-contact

socket and may be mounted in any position. Outline 13, OUTLINES SECTION. It is especially important that this tube, like other power-handling tubes, be adequately ventilated. For discussion of Rating Chart and Operation Characteristics, refer to type 6AX5-GT.

HEATER VOLTAGE (AC/DC).....	6.3	volts
HEATER CURRENT.....	0.6	ampere

Maximum Ratings:		FULL-WAVE RECTIFIER	
PEAK INVERSE PLATE VOLTAGE.....	1250 max	volts	
PEAK PLATE CURRENT (Per Plate).....	210 max	ma	
AC PLATE SUPPLY VOLTAGE (Per Plate, rms).....	See Rating Chart		
DC OUTPUT CURRENT (Per Plate).....	See Rating Chart		
HOT-SWITCHING TRANSIENT PLATE CURRENT.....	#		
PEAK HEATER-CATHODE VOLTAGE:			
Heater negative with respect to cathode.....	450 max	volts	
Heater positive with respect to cathode.....	450 max	volts	

**Typical Operation:**

Filter Input	Capacitor	Choke	
AC Plate-to-Plate Supply Voltage (rms).....	550	900	volts
Filter Input Capacitor.....	10*	-	μf
Effective Plate Supply Impedance per Plate.....	520	-	ohms
Minimum Filter Input Choke.....	-	10	henries
DC Output Voltage at Input to Filter (Approx.):			
At half-load current of 35 ma.....	360	385	volts
At full-load current of 70 ma.....	300	370	volts

# If hot-switching is regularly required in operation, the use of choke-input circuits is recommended. Such circuits limit the hot-switching current to a value no higher than that of the peak plate current. When capacitor-input circuits are used, a maximum peak current value per plate of 1 ampere during the initial cycles of the hot-switching transient should not be exceeded.

\* Higher values of capacitance than indicated may be used, but the effective plate-supply impedance should be increased to prevent exceeding the maximum rating for peak plate current.

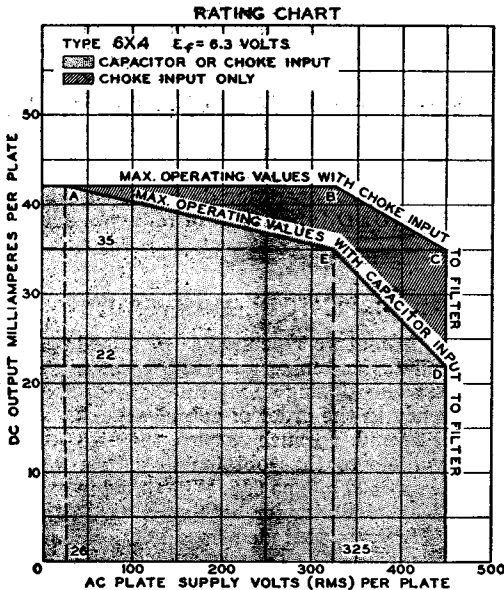

92CM-8025T

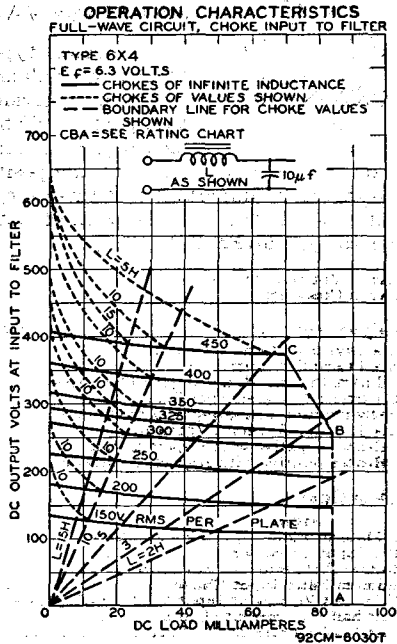
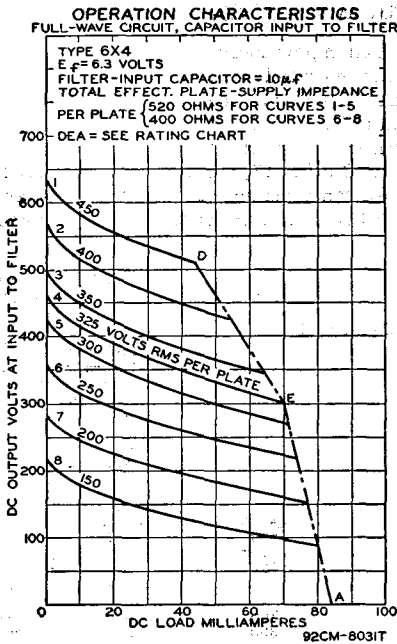

**6X5**  
**6X5-GT**

**FULL-WAVE VACUUM RECTIFIER**

Metal type 6X5 and glass-octal type 6X5-GT are used in power supply of automobile and ac-operated receivers. Outlines 6 and 23, respectively, OUTLINES SECTION. Type 6X5-

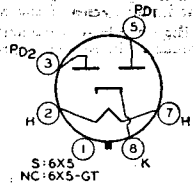

GT may be supplied with pin No.1 omitted. Both types require octal socket. Type 6X5 should be mounted in vertical position, but horizontal operation is permissible if pins 3 and 5 are in horizontal plane. Type 6X5-GT may be operated in any position. For maximum ratings, typical operation data, and curves, refer to type 6X4. Type 6X5 is a DISCONTINUED type listed for reference only.

**6X8**

**TRIODE-PENTODE CONVERTER**

Miniature type used as combined oscillator and mixer tube in television receivers utilizing an intermediate frequency in the order of 40 megacycles per second. In such service, the 6X8

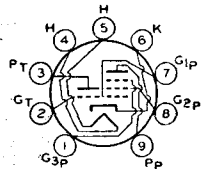

gives performance comparable to that obtainable with a 6AG5 mixer and an oscillator consisting of one unit of a type 6J6. When used in an AM/FM receiver, the triode unit is used as an oscillator for both sections. In the AM section, the pentode unit is used as a high-gain pentode mixer; in the FM section, the pentode unit is used either as a pentode mixer or as a triode-connected mixer depending on signal-to-noise considerations. Outline 12, OUTLINES SECTION. Tube requires miniature nine-contact socket and may be mounted in any position.

# RCA Receiving Tube Manual

HEATER VOLTAGE.....	6.3	volts
HEATER CURRENT.....	0.45	ampere

DIRECT INTERELECTRODE CAPACITANCES (Approx.):	Without External Shield	With External Shield	
<b>TRIODE UNIT:</b>			
Grid to Plate.....	1.4	1.4	$\mu\text{f}$
Grid to Cathode and Heater.....	2.0	2.6	$\mu\text{f}$
Plate to Cathode and Heater.....	0.5	1.0	$\mu\text{f}$
<b>PENTODE UNIT:</b>			
Grid No.1 to Plate.....	0.09 max	0.06 max	$\mu\text{f}$
Grid No.1 to Cathode, Heater, Grid No.2, and Grid No.3.....	4.3	4.5	$\mu\text{f}$
Plate to Cathode, Heater, Grid No.2, and Grid No.3.....	0.7	1.4	$\mu\text{f}$
Pentode Grid No.1 to Triode Plate.....	0.045 max	0.035 max	$\mu\text{f}$
Pentode Plate to Triode Plate.....	0.040 max	0.008 max	$\mu\text{f}$

**Characteristics:**

	Triode Unit	Pentode Unit	
Plate Supply Voltage.....	100	250	volts
Grid No.3 (Suppressor Grid).....	-	Connected to cathode at socket	
Grid-No.2 Supply Voltage.....	-	150	volts
Cathode-Bias Resistor.....	100	200	ohms
Amplification Factor.....	40	-	
Plate Resistance (Approx.).....	6900	750000	ohms
Transconductance.....	5800	4600	$\mu\text{mhos}$
Grid-No.1 Voltage for plate current of 10 $\mu\text{a}$ .....	-10	-10	volts
Plate Current.....	8.5	7.7	ma
Grid-No.2 Current.....	-	1.6	ma

## CONVERTER SERVICE

**Maximum Ratings:**

	Triode Unit as Osc.	Pentode Unit as Mixer	
PLATE VOLTAGE.....	250 max	250 max	volts
GRID-NO.2 SUPPLY VOLTAGE.....	-	250 max	volts
GRID-NO.2 (SCREEN-GRID) VOLTAGE.....	-	See curve page 67	
<b>GRID-NO.1 (CONTROL-GRID) VOLTAGE:</b>			
Negative bias value.....	40 max	40 max	volts
Positive bias value.....	0 max	0 max	volts
PLATE DISSIPATION.....	1.5 max	2.0 max	watts
<b>GRID-NO.2 INPUT:</b>			
For grid-No.2 voltages up to 125 volts.....	-	0.4 max	watt
For grid-No.2 voltages between 125 and 250 volts.....	-	See curve page 67	
<b>GRID-NO.1 INPUT:</b>			
For grid-No.1 input.....	0.5 max	-	watt
<b>PEAK HEATER-CATHODE VOLTAGE:</b>			
Heater negative with respect to cathode.....	100 max	100 max	volts
Heater positive with respect to cathode.....	100 max	100 max	volts

AVERAGE PLATE CHARACTERISTICS  
TRIODE UNIT

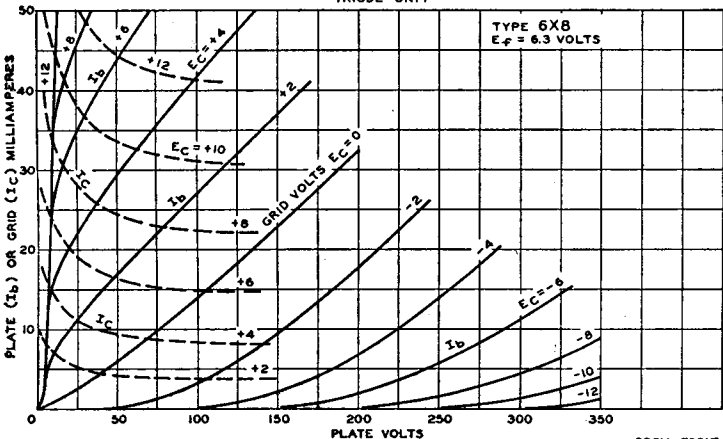

92CM-7531T

## Typical Operation:

	Triode Unit as 250-Mc Osc.	Pentode Unit as Mixer*	
Plate Voltage.....	150	150	volts
Grid No.3.....	-	Connected to cathode at socket	
Grid-No.2 Voltage.....	-	150	volts
Mixer Grid-No.1 Supply Voltage.....	-	-3.5	volts
Oscillator Voltage at Mixer Grid No.1.....	-	2.6 rms	volts
Mixer Grid-No.1-Circuit Resistance.....	-	120000	ohms
Oscillator Grid Resistor.....	2700	-	ohms
Conversion Transconductance.....	-	2100	$\mu$ mhos
Plate Current.....	13	6.2	ma
Grid-No.2 Current.....	-	1.8	ma
Grid-No.1 Current.....	-	2.0	$\mu$ a
Oscillator Power Output (Approx.).....	0.5†	-	watt

## Maximum Circuit Values:

### Grid-No.1-Circuit Resistance:

For fixed-bias operation.....	0.1 max	megohm
For cathode-bias operation.....	0.5 max	megohm

\*With separate excitation and triode unit grounded.

†In TV or FM receivers, it is generally desirable to operate the oscillator with less power input than shown in the tabulated data in order to avoid over-excitation and excessive oscillator radiation.

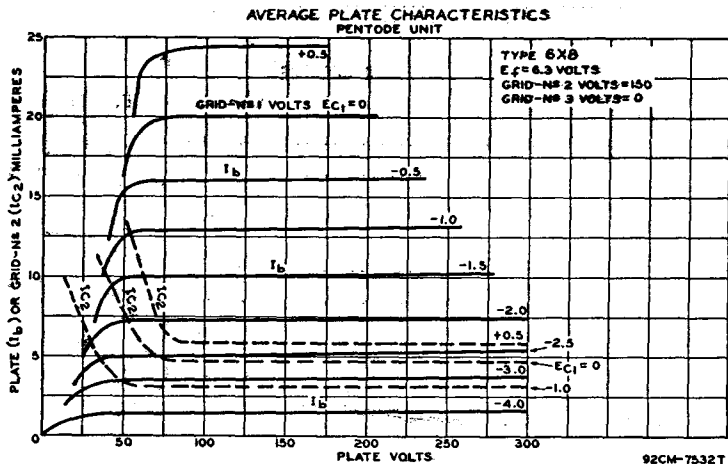

## FULL-WAVE VACUUM RECTIFIER

# 6Y5

Glass type used in power supply of radio receivers. Outline 34 or 35, OUTLINES SECTION. Heater volts (ac/dc), 6.3; amperes, 0.8. The maximum ac plate voltage per plate is 350 volts (rms), and the dc output current is 50 ma. This is a DISCONTINUED type listed for reference only.

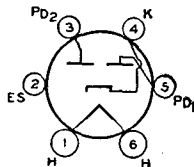

## BEAM POWER TUBE

# 6Y6-G

Glass octal type used as output amplifier in radio receivers in which the plate voltage available for the output stage is relatively low. It is also used in rf-operated, high-voltage power supplies in television equipment. Outline 41, OUTLINES SECTION. Tube requires octal socket and may be mounted in any position. Heater volts (ac/dc), 6.3; amperes, 1.25. Typical operation and maximum ratings as class A<sub>1</sub> amplifier:

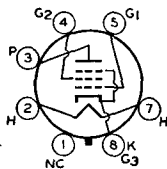

plate volts, 135 (200 max); grid-No.2 (screen-grid) volts, 135 max; plate dissipation, 12.5 max watts; grid-No.2 input, 1.75 max watts; grid-No.1 (control-grid) volts, -13.5; plate ma., 58; grid-No.2



ma., 3.5; plate resistance, 9300 ohms; transconductance, 7000  $\mu$ mhos; load resistance, 2000 ohms; maximum-signal output watts, 3.6. At maximum ratings, the 6Y6-G can deliver 6 watts output with load resistance of 2600 ohms. This type is used principally for renewal purposes.

## RF POWER AMPLIFIER AND OSCILLATOR—Class C Telegraphy

### Maximum Ratings:

DC PLATE VOLTAGE.....	350 <i>max</i>	volts
DC GRID-No.2 VOLTAGE.....	135 <i>max</i>	volts
DC GRID-No.1 VOLTAGE.....	-90 <i>max</i>	volts
DC PLATE CURRENT.....	80 <i>max</i>	ma
DC GRID-No.1 CURRENT.....	1.5 <i>max</i>	ma
PLATE INPUT.....	23 <i>max</i>	watts
GRID-No.2 INPUT.....	0.6 <i>max</i>	watt
PLATE DISSIPATION.....	8.0 <i>max</i>	watts

### Typical Operation:

DC Plate Voltage.....	350	volts
DC Grid-No.2 Voltage*.....	115	volts
DC Grid-No.1 Voltage†.....	-40	volts
Peak RF Grid-No.1 Voltage.....	48	volts
DC Plate Current.....	60	ma
DC Grid-No.2 Current.....	5.1	ma
DC Grid-No.1 Current (Approx.).....	1.4	ma
Driving Power (Approx.).....	0.1	watt
Power Output (Approx.).....	14	watts

\* Obtained from a separate source, from a potentiometer, or from plate supply through a series resistor of 45000 ohms.

† Obtained from fixed supply, by grid-No.1 resistor of 30000 ohms, by cathode resistor of 600 ohms, or by a combination of methods.

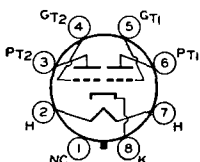

### HIGH-MU TWIN POWER TRIODE

Glass octal type used as class B amplifier in output stage of radio receivers. Outline 36, OUTLINES SECTION. For electrical characteristics, refer to type 79. Heater volts (ac/dc), 6.3; amperes, 0.6. This is a DISCONTINUED type listed for reference only

## 6Y7-G

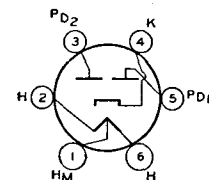

### FULL-WAVE VACUUM RECTIFIER

Glass type used in power supply of radio receivers. Outline 35, OUTLINES SECTION. Heater volts (ac/dc), 12.6 in series heater arrangement and 6.3 in parallel arrangement; amperes, 0.4 (series), 0.8 (parallel). Maximum ac plate voltage per plate is 230 volts, and maximum dc output current is 60 ma. This is a DISCONTINUED type listed for reference only.

## 6Z5

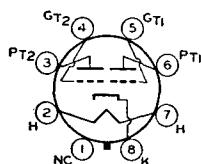

### HIGH-MU TWIN POWER TRIODE

Glass octal type used as class B amplifier in output stage of radio receivers. Outline 36, OUTLINES SECTION. Tube requires octal socket. Heater volts (ac/dc), 6.3; amperes 0.3. Typical operation and maximum ratings as class B power amplifier: plate volts, 180 *max*; grid volts, 0; peak plate ma. per plate, 60 *max*; average plate dissipation, 8 *max* watts; zero-

## 6Z7-G

signal plate ma. per plate, 4.2; plate-to-plate load resistance, 12000 ohms; output watts, 4.2 with average input of 320 milliwatts applied between grids. This is a DISCONTINUED type listed for reference only.

### FULL-WAVE VACUUM RECTIFIER

Glass octal type used in power supply of radio equipment where economy of power is important. Outline 36, OUTLINES SECTION. Tube requires octal socket and may be mounted in any position. Heater volts (ac/dc), 6.3; amperes, 0.3. Maximum ratings: peak inverse plate volts, 1250; peak plate ma. per plate, 120; dc output ma., 40; peak heater-cathode volts, 450. This is a DISCONTINUED type listed for reference only.

## 6ZY5-G

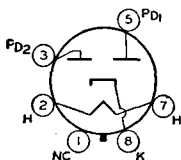

## 7A4

### MEDIUM-MU TRIODE

Glass lock-in type used as detector, amplifier, or oscillator in radio equipment. Outline 15, OUTLINES SECTION. Tube requires lock-in socket. Heater volts (ac/dc), 6.3; amperes, 0.3. Maximum ratings, typical operating conditions, and curves for type 7A4 are the same as for metal type 6J5. Type 7A4 is used principally for renewal purposes.

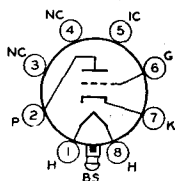

## 7A5

### BEAM POWER TUBE

Glass lock-in type used as output amplifier in radio receivers in which the plate voltage available for the output stage is relatively low. Outline 20, OUTLINES SECTION. Tube requires lock-in socket. Heater volts (ac/dc), 6.3; amperes, 0.75. Typical operation and maximum ratings as class A<sub>1</sub> amplifier: plate volts, 110 (125 max); grid-No.2 volts, 110 (125 max); plate dissipation, 5.5 max watts; grid-No.2 input, 1.2 max watts; grid-No.1 volts, 7.5; plate ma., 40; grid-No.2 ma., 3; plate resistance, 16000 ohms; transconductance, 5800 μmhos; load resistance, 2500 ohms; maximum-signal output watts, 1.5. Type 7A5 is used principally for renewal purposes.

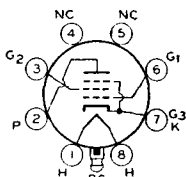

## 7A6

### TWIN DIODE

Glass lock-in type used as detector, low-voltage rectifier, or avc tube. Outline 15, OUTLINES SECTION. Tube requires lock-in socket. Heater volts (ac/dc), 6.3; amperes, 0.15. Maximum ratings as rectifier: ac plate volts per plate (rms), 150; dc output ma. per plate, 8; peak ma. per plate, 45; peak heater-cathode volts, 330. The application of this type is similar to that of metal type 6H6. Type 7A6 is used principally for renewal purposes.

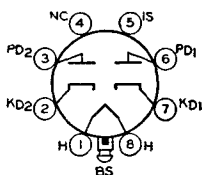

## 7A7

### REMOTE-CUTOFF PENTODE

Glass lock-in type used as rf or if amplifier in radio receivers. Outline 15, OUTLINES SECTION. Tube requires lock-in socket. Heater volts (ac/dc), 6.3; amperes, 0.3. For maximum ratings, typical operation, and curves, refer to metal type 6SK7. Type 7A7 is used principally for renewal purposes.

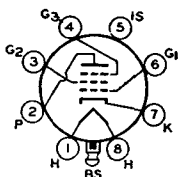

## 7A8

### OCTODE CONVERTER

Glass lock-in type used as converter in superheterodyne circuits. Outline 15, OUTLINES SECTION. Tube requires lock-in socket. Heater volts (ac/dc), 6.3; amperes, 0.15. Typical operation and maximum ratings as frequency converter: plate volts, 250 (300 max); grids-No.3-and-No.5 volts, 100 max; grid-No.2 supply volts, 250 (300 max) applied through

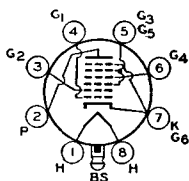

20000-ohm dropping resistor properly bypassed; grid-No.2 volts, 165 (200 max); plate dissipation, 1 max watt; grids-No.3-and-No.5 input, 0.3 max watt; grid-No.2 input, 0.75 max watt; grid-No.4 volts, -3 (0 min); grid-No.1 resistor, 50000 ohms; plate ma., 3; grids-No.3-and-No.5 ma., 8.2; grid-No.2 ma., 4.2; grid-No.1 ma., 0.4; plate resistance, 0.7 megohm; conversion transconductance, 550 μmhos; conversion transconductance with grid-No.1 bias of -30 volts, 2 μmhos. The application of this type is similar to that of metal type 6A8 and glass-octal type 6D8-G. Type 7A8 is used principally for renewal purposes.

**POWER PENTODE**

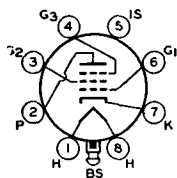

ohms; plate ma., 28; grid-No.2 ma., 7; plate resistance, 300000 ohms; transconductance, 9500  $\mu$ mhos. This type is used principally for renewal purposes.

**7AD7**

**MEDIUM-MU TWIN TRIODE**

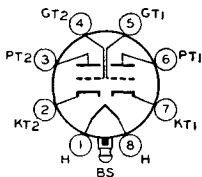

Glass lock-in type used as voltage amplifier or phase inverter in radio equipment. Outline 15, OUTLINES SECTION. Tube requires lock-in socket. Heater volts (ac/dc), 6.3; amperes, 0.3. Ratings and characteristics as class A<sub>1</sub> amplifier (each section): plate volts, 250 (300 max); cathode-bias resistor, 1100 ohms; plate ma., 9; transconductance, 2100  $\mu$ mhos; amplification factor, 16; plate resistance, 7600 ohms. This type is used principally for renewal purposes.

**7AF7**

**SHARP-CUTOFF PENTODE**

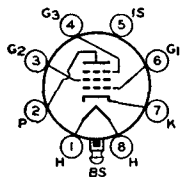

No.3 and internal shield connected to cathode at socket; plate resistance (approx.), 0.75 megohm; transconductance, 4200  $\mu$ mhos; grid-No.1 voltage for plate current of 10  $\mu$ a., -10; cathode-bias resistor, 250 ohms; plate ma., 6; grid-No.2 ma., 2. The application of this type is similar to that of miniature type 6BH6. Type 7AG7 is used principally for renewal purposes.

**7AG7**

**REMOTE-CUTOFF PENTODE**

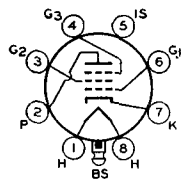

connected to cathode at socket; plate resistance (approx.), 1 megohm; transconductance, 3300  $\mu$ mhos; grid-No.1 voltage for transconductance of 35  $\mu$ mhos, -20 volts; plate ma., 6.8; grid-No.2 ma., 1.9. The application of this type is similar to that of miniature type 6BJ6. Type 7AH7 is used principally for renewal purposes.

**7AH7**

**MEDIUM-MU TWIN TRIODE**

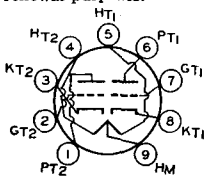

Miniature type used as a combined vertical deflection amplifier and vertical deflection oscillator, and as a horizontal deflection oscillator, in television receivers employing series-connected heater strings. Also used as audio mixer, phase inverter, multivibrator, sync separator and amplifier, and resistance-coupled amplifier in radio equipment. Outline 12, OUTLINES SECTION. Tube requires miniature nine-contact socket and may be mounted in any position. Each triode unit is independent of

**7AU7**

the other except for the common heater. For direct interelectrode capacitances and class A<sub>1</sub> amplifier data, refer to miniature type 12AU7. For typical operation as phase inverter or resistance-coupled amplifier, refer to Chart 10, RESISTANCE-COUPLED AMPLIFIER SECTION.

HEATER ARRANGEMENT	<i>Series</i>	<i>Parallel</i>	
HEATER VOLTAGE (AC/DC).....	7.0	3.5	volts
HEATER CURRENT.....	0.3	0.6	ampere
HEATER WARM-UP TIME (Average)*.....	—	11	seconds

\*For definition of heater warm-up time and method for determining it, see type 6CG7.

### OSCILLATOR

*For operation in a 525-line, 30-frame system*

Maximum Ratings (Each Unit):	<i>Vertical Deflection Oscillator</i>	<i>Horizontal Deflection Oscillator</i>	
DC PLATE VOLTAGE.....	300 max	300 max	volts
PEAK NEGATIVE-PULSE GRID VOLTAGE.....	-400 max	-600 max	volts
CATHODE CURRENT:			
Peak.....	60 max	300 max	ma
Average.....	20 max	20 max	ma
PLATE DISSIPATION.....	2.75 max	2.75 max	watts
PEAK HEATER-CATHODE VOLTAGE:			
Heater negative with respect to cathode.....	200 max	200 max	volts
Heater positive with respect to cathode.....	200 max	200 max	volts
Maximum Circuit Value:			
Grid-Circuit Resistance.....	2.2 max	2.2 max	megohms

### VERTICAL DEFLECTION AMPLIFIER

*For operation in a 525-line, 30-frame system*

Maximum Ratings (Each Unit):		
DC PLATE VOLTAGE.....	300 max	volts
PEAK POSITIVE-PULSE PLATE VOLTAGE † (Absolute Maximum).....	1200 max	volts
PEAK NEGATIVE-PULSE GRID VOLTAGE.....	-250 max	volts
CATHODE CURRENT:		
Peak.....	60 max	ma
Average.....	20 max	ma
PLATE DISSIPATION.....	2.75 max	watts
PEAK HEATER-CATHODE VOLTAGE:		
Heater negative with respect to cathode.....	200 max	volts
Heater positive with respect to cathode.....	200 max	volts

Maximum Circuit Values:

Grid-Circuit Resistance:	
For cathode-bias operation.....	2.2 max megohms

#The duration of the voltage pulse must not exceed 15 per cent of one vertical scanning cycle. In a 525-line, 30-frame system, 15 per cent of one vertical scanning cycle is 2.5 milliseconds.

† Under no circumstances should this absolute value be exceeded.

■ The dc component must not exceed 100 volts.

## HIGH-MU TRIODE

Glass lock-in type used in resistance-coupled amplifier circuits. Outline 15, OUTLINES SECTION. Tube requires lock-in socket. Heater volts (ac/dc), 6.3; amperes, 0.3. Except for interelectrode capacitances, this type has the same maximum ratings and characteristics as metal types 6F5 and 6SF5. Type 7B4 is used principally for renewal purposes.

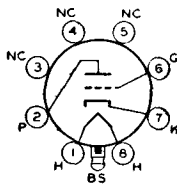

# 7B4

## POWER PENTODE

Glass lock-in type used in output stage of radio receivers. Outline 20, OUTLINES SECTION. Tube requires lock-in socket. Heater volts (ac/dc), 6.3; amperes, 0.4. Except for interelectrode capacitances, this type is the same electrically as glass-octal type 6K6-GT. Type 7B5 is used principally for renewal purposes.

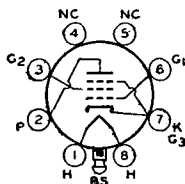

# 7B5

### TWIN DIODE—HIGH-MU TRIODE

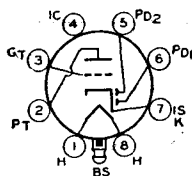

Glass lock-in type used as combined detector, amplifier, and avc tube. Outline 15, OUTLINES SECTION. Tube requires lock-in socket. Heater volts (ac/dc), 6.3; amperes, 0.3. Except for interelectrode capacitances, this type is the same electrically as metal type 6SQ7. Type 7B6 is used principally for renewal purposes.

7B6

### REMOTE-CUTOFF PENTODE

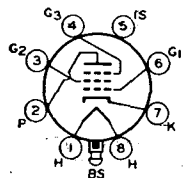

Glass lock-in type used as rf or if amplifier in radio receivers employing avc. Outline 15, OUTLINES SECTION. Tube requires lock-in socket. Heater volts (ac/dc), 6.3; amperes, 0.15. Typical operation as class A<sub>1</sub> amplifier: plate volts, 250 (300 max); grid-No.2 volts, 100; grid-No.1 volts, -3; grid No.3 connected to cathode at socket; plate ma., 8.5; grid-No.2

7B7

ma., 1.7; plate resistance, 0.75 megohm; transconductance, 1750  $\mu$ mhos; transconductance at grid-No.1 voltage of -40 volts, 10  $\mu$ mhos. The application of this type is similar to that of metal types 6SK7 and 6SS7. Type 7B7 is used principally for renewal purposes.

### PENTAGRID CONVERTER

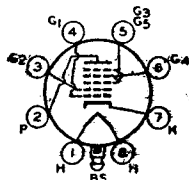

Glass lock-in type used as frequency converter in superheterodyne circuits. Outline 15, OUTLINES SECTION. Tube requires lock-in socket. Heater volts (ac/dc), 6.3; amperes, 0.3. Except for interelectrode capacitances, this type is the same electrically as metal type 6A8. Type 7B8 is used principally for renewal purposes.

7B8

### BEAM POWER TUBE

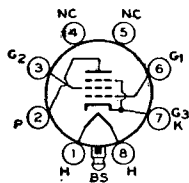

Glass lock-in type used as output amplifier in radio receivers. Outline 20, OUTLINES SECTION. Tube requires lock-in socket. Heater volts (ac/dc), 6.3; amperes, 0.45. Refer to metal type 6V6 for maximum ratings and typical operation as single-tube class A<sub>1</sub> amplifier and as push-pull amplifier, and for curves, to miniature type 6AQ5. Type 7C5 is used principally for renewal purposes.

7C5

### TWIN DIODE—HIGH-MU TRIODE

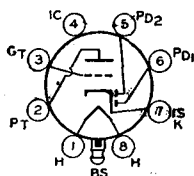

Glass lock-in type used as combined detector, amplifier, and avc tube. Outline 15, OUTLINES SECTION. Tube requires lock-in socket. Heater volts (ac/dc), 6.3; amperes, 0.15. Typical operation of triode unit as class A<sub>1</sub> amplifier: plate volts, 250 (300 max); grid volts, -1; plate ma., 1.3; plate resistance, 0.1 megohm; transconductance, 1000  $\mu$ mhos. For diode operation curves and triode application, refer to miniature type 6AV6. Type 7C6 is used principally for renewal purposes.

7C6

### SHARP-CUTOFF PENTODE

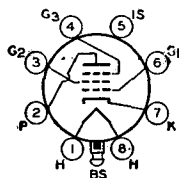

Glass lock-in type used as biased detector or rf amplifier. Outline 15, OUTLINES SECTION. Tube requires lock-in socket. Heater volts (ac/dc), 6.3; amperes, 0.15. Typical operation as class A<sub>1</sub> amplifier: plate volts, 250 (300 max); grid-No.2 volts, 100; grid-No.1 volts, -3 (0 min); grid No.3 and internal shield connected to cathode at socket; plate resistance

7C7

(approx.), 2 megohms; plate ma., 2; grid-No.2 ma., 0.5; transconductance, 1300  $\mu$ mhos. The application of this type is similar to that of metal type 6SJ7 and glass-octal type 6W7-G. Type 7C7 is used principally for renewal purposes.

**TWIN DIODE—MEDIUM-MU TRIODE**

**7E6**

Glass lock-in type used as combined detector, amplifier, and avc tube. Outline 15, OUTLINES SECTION. Tube requires lock-in socket. Heater volts (ac/dc), 6.3; amperes, 0.3. For maximum ratings, typical operation, and curves, refer to miniature type 6BF6. Type 7E6 is a DISCONTINUED type listed for reference only.

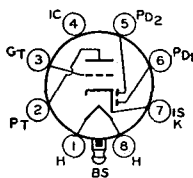

**TWIN DIODE—REMOTE-CUTOFF PENTODE**

**7E7**

Glass lock-in type used as combined detector, amplifier, and avc tube. Outline 15, OUTLINES SECTION. Tube requires lock-in socket. Heater volts (ac/dc), 6.3; amperes, 0.3. Typical operation and maximum ratings of pentode unit as class A<sub>1</sub> amplifier: plate volts, 250 (300 max); grid-No.2 volts, 100 max; plate dissipation, 2 max watts; grid-No.2 input, 0.3 max watt; cathode-bias resistor, 330 ohms; plate resistance (approx.), 0.7 megohm; transconductance, 1300  $\mu$ mhos; grid-No.1 voltage for transconductance of 2  $\mu$ mhos, -42.5; plate ma., 7.5; grid-No.2 ma., 1.6. For diode operation curves, refer to type 6AV6. Type 7E7 is used principally for renewal purposes.

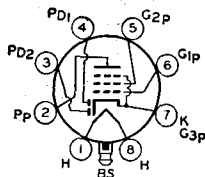

**HIGH-MU TWIN TRIODE**

**7F7**

Glass lock-in type used as phase inverter or resistance-coupled amplifier. Outline 15, OUTLINES SECTION. Tube requires lock-in socket. Heater volts (ac/dc), 6.3; amperes, 0.3. For maximum ratings, typical operation as class A<sub>1</sub> amplifier, and curves, refer to glass-octal type 6SL7-GT. Type 7F7 is used principally for renewal purposes.

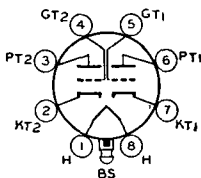

**MEDIUM-MU TWIN TRIODE**

**7F8**

Glass lock-in type used as amplifier or oscillator in radio equipment. Outline 15, OUTLINES SECTION, except over-all length is 2-9/32 max inches and seated length is 1-3/4 inches. Tube requires lock-in socket. Heater volts (ac/dc), 6.3; amperes, 0.3. Typical operation and maximum ratings as class A<sub>1</sub> amplifier (per unit): plate volts, 250 (300 max); cathode-bias resistor, 500 ohms; plate ma., 6.0; transconductance, 3300  $\mu$ mhos; amplification factor, 48; grid voltage for plate current of 10  $\mu$ a., -1i; grid-circuit resistance, 0.5 max megohm. Type 7F8 is used principally for renewal purposes.

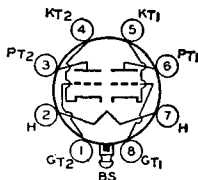

**SHARP-CUTOFF PENTODE**

**7G7**

Glass lock-in type used in video amplifiers of television receivers and in other applications requiring high transconductance. Outline 15, OUTLINES SECTION. Tube requires lock-in socket. Heater volts (ac/dc), 6.3; amperes, 0.45. Typical operation and maximum ratings as class A<sub>1</sub> amplifier: plate volts, 250 (300 max); grid-No.2 volts, 100; plate dissipation, 1.5 max watts; grid-No.2 input, 0.3 max watt; grid-No.1 volts, -2; grid No.3 and internal shield connected to cathode at socket; plate resistance (approx.), 0.8 megohm; transconductance, 4500  $\mu$ mhos; grid-No.1 voltage for cathode-current cutoff, -7; plate ma., 6; grid-No.2 ma., 2.0. The application of this type is similar to that of miniature type 6AU6. Type 7G7 is used principally for renewal purposes.

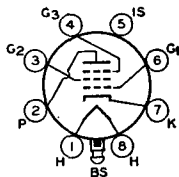

### REMOTE-CUTOFF PENTODE

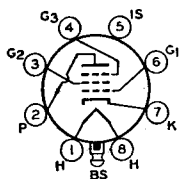

Glass lock-in type used as rf or lf amplifier in radio receivers. Outline 15, OUTLINES SECTION. Tube requires lock-in socket. Heater volts (ac/dc), 6.3; amperes, 0.3. Typical operation and maximum ratings as class A<sub>1</sub> amplifier: plate volts, 250 (300 max); grid-No.2 volts, 150; plate dissipation, 2.5 max watts; grid-No.2 input, 0.5 max watt; grid No.3 and internal shield connected to cathode at socket; cathode-bias resistor, 180 ohms; plate resistance (approx.), 0.8 megohm; transconductance, 4000 μmhos; grid-No.1 volts for transconductance of 35 μmhos, -19; plate ma., 10; grid-No.2 ma., 3.2 The application of this type is similar to that of miniature type 6BA6. Type 7H7 is used principally for renewal purposes.

7H7

terminal shield connected to cathode at socket; cathode-bias resistor, 180 ohms; plate resistance (approx.), 0.8 megohm; transconductance, 4000 μmhos; grid-No.1 volts for transconductance of 35 μmhos, -19; plate ma., 10; grid-No.2 ma., 3.2 The application of this type is similar to that of miniature type 6BA6. Type 7H7 is used principally for renewal purposes.

### TRIODE—HEPTODE CONVERTER

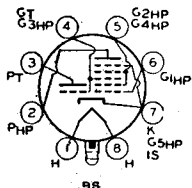

Glass lock-in type used as combined oscillator and heptode mixer in radio receivers. Outline 15, OUTLINES SECTION. Tube requires lock-in socket. Heater volts (ac/dc), 6.3; amperes, 0.3. For maximum ratings and typical operation, refer to glass-octal type 6J8-G. Type 7J7 is used principally for renewal purposes.

7J7

### TWIN DIODE—HIGH-MU TRIODE

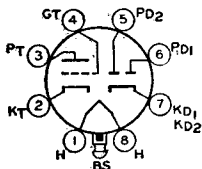

Glass lock-in type used as FM detector and audio amplifier in circuits which require diode and triode units with separate cathodes. Outline 15, OUTLINES SECTION. Tube requires lock-in socket. Heater volts (ac/dc), 6.3; amperes, 0.3. For ratings and typical operation, refer to glass-octal type 6AQ7-GT. Type 7K7 is used principally for renewal purposes.

7K7

### SHARP-CUTOFF PENTODE

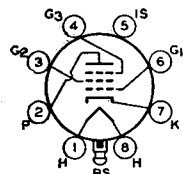

Glass lock-in type used as rf and lf amplifier in radio equipment. Outline 15, OUTLINES SECTION. Tube requires lock-in socket. Heater volts (ac/dc), 6.3; amperes, 0.3. Typical operation as class A<sub>1</sub> amplifier: plate volts, 250 (300 max); grid-No.2 volts, 100; grid-No.1 volts, -1.5; grid No.3 tied to cathode at socket; cathode-bias resistor, 250 ohms; plate ma., 4.5; grid-No.2 ma., 1.5; plate resistance (approx.), 1 megohm; transconductance, 3100 μmhos. The application of this type is similar to that of miniature type 6AU6. Type 7L7 is used principally for renewal purposes.

7L7

grid-No.2 ma., 1.5; plate resistance (approx.), 1 megohm; transconductance, 3100 μmhos. The application of this type is similar to that of miniature type 6AU6. Type 7L7 is used principally for renewal purposes.

### MEDIUM-MU TWIN TRIODE

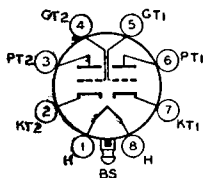

Glass lock-in type used as voltage amplifier or phase inverter in radio equipment. Outline 20, OUTLINES SECTION. Tube requires lock-in socket. Heater volts (ac/dc), 6.3; amperes, 0.6. For maximum ratings and typical operation of each triode unit, refer to metal type 6J5. The application of this type is similar to that of glass-octal type 6SN7-GT. Type 7N7 is used principally for renewal purposes.

7N7

### PENTAGRID CONVERTER

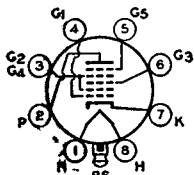

Glass lock-in type used as converter in superheterodyne circuits. Outline 15, OUTLINES SECTION. Tube requires lock-in socket. Heater volts (ac/dc), 6.3; amperes, 0.3. For maximum ratings, typical operation in converter service, and curves, refer to metal type 6SA7. Type 7Q7 is used principally for renewal purposes.

7Q7

**TWIN DIODE—  
REMOTE-CUTOFF PENTODE**

**7R7**

Glass lock-in type used as combined detector, amplifier, and avc tube. Outline 15, **OUTLINES SECTION**. Tube requires lock-in socket. Heater volts (ac/dc), 6.3; amperes, 0.3. Typical operation and ratings of pentode unit as class A<sub>1</sub> amplifier: plate volts, 250 *max*; grid-No.2 volts, 100; plate dissipation, 2 *max* watts; grid-No.2 input, 0.25 *max* watt; grid-No.1

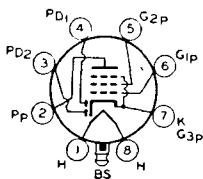

volts, -1 (0 *min*); plate resistance (approx.), 1.0 megohm; transconductance, 3200  $\mu$ mhos; plate ma., 5.7; grid-No.2 ma., 2.1, grid-No.1 volts for transconductance of 10  $\mu$ mhos, -30. Refer to type 6AV6 for diode operation curves. Type 7R7 is used principally for renewal purposes.

**TRIODE—HEPTODE CONVERTER**

**7S7**

Glass lock-in type used as combined triode oscillator and heptode mixer in radio receivers. Outline 15, **OUTLINES SECTION**. Tube requires lock-in socket. Heater volts (ac/dc), 6.3; amperes, 0.3. Typical operation of heptode unit: plate volts, 250 (300 *max*); grids-No.2-and-No.4

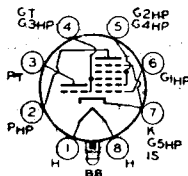

volts, 100; grid-No.1 volts, -2; plate resistance, 1.25 megohms; conversion transconductance, 525  $\mu$ mhos; plate ma., 1.8; grids-No.2-and-No.4 ma., 3.0. Typical operation of triode unit: plate supply volts, 250 (300 *max*) applied through a 20000-ohm dropping resistor bypassed by a 0.1- $\mu$ f capacitor; grid resistor, 50000 ohms; plate ma., 5.0; total cathode ma. (both units), 10.2. This is a **DISCONTINUED** type listed for reference only.

**SHARP-CUTOFF PENTODE**

**7V7**

Glass lock-in type used as rf or if amplifier in radio receivers. Outline 15, **OUTLINES SECTION**. Tube requires lock-in socket. Heater volts (ac/dc), 6.3; amperes, 0.45. Typical operation and maximum ratings as class A<sub>1</sub> amplifier: plate volts and grid-No.2 supply volts, 300 *max*; grid-No.2 series resistor, 40000 ohms; plate dissipation, 4 *max* watts; grid-No.2 input,

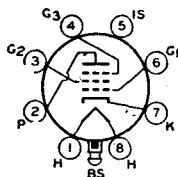

0.8 *max* watt; grid No.3 connected to cathode at socket; cathode-bias resistor, 160 *min* ohms; plate resistance, 0.3 megohm; transconductance, 5800  $\mu$ mhos; plate ma., 10; grid-No.2 ma., 3.9; grid-No.1 volts for plate current of 10  $\mu$ a., -16. The application of this type is similar to that of miniature type 6AU6. Type 7V7 is used principally for renewal purposes.

**SHARP-CUTOFF PENTODE**

**7W7**

Glass lock-in type used as rf or if amplifier in radio receivers. Outline 15, **OUTLINES SECTION**. Tube requires lock-in socket. Heater volts (ac/dc), 6.3; amperes, 0.45. This type is the same as type 7V7 except for socket connections. Type 7W7 is used principally for renewal purposes.

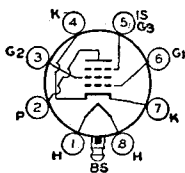

**TWIN DIODE—HIGH-MU TRIODE**

**7X7**

Glass lock-in type used as combined detector, amplifier, and avc tube in circuits which require diodes with separate cathodes. Outline 20, **OUTLINES SECTION**. Tube requires lock-in socket. Heater volts (ac/dc), 6.3; amperes, 0.3. Ratings and characteristics of triode unit as class A<sub>1</sub> amplifier: plate volts, 250 (300 *max*); grid volts, -1; amplification factor, 100; plate resistance, 67000 ohms; transconductance, 1500  $\mu$ mhos; plate ma., 1.9. Type 7X7 is used principally for renewal purposes.

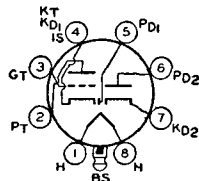



**FULL-WAVE VACUUM RECTIFIER**

Glass lock-in type used in power supply of automobile radio receivers and compact ac-operated receivers. Outline 15, OUTLINES SECTION. Tube requires lock-in socket. Heater volts (ac/dc), 6.3; amperes, 0.5. Maximum ratings: peak inverse plate volts, 1250; peak plate ma. per plate, 180; dc output ma., 70; peak heater-cathode volts, 450. For typical operation, refer to miniature type 6X4. Type 7Y4 is used principally for renewal purposes.

**7Y4**

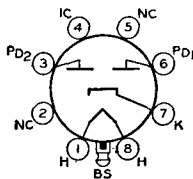

**FULL-WAVE VACUUM RECTIFIER**

Glass lock-in type used in power supply of automobile and ac-operated radio receivers. Outline 20, OUTLINES SECTION. Tube requires lock-in socket. Heater volts (ac/dc), 6.3; amperes, 0.9. Maximum ratings: peak inverse plate volts, 1250; peak plate ma. per plate, 300; dc output ma., 100; peak heater-cathode volts, 450. Type 7Z4 is used principally for renewal purposes.

**7Z4**

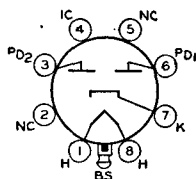

**FULL-WAVE RECTIFIER**

**Typical Operation:**

Filter Input	Capacitor	Choke	
AC Plate-to-Plate Supply Voltage (rms) .....	650	900	volts
Filter-Input Capacitor .....	4	-	$\mu$ f
Min. Total Effective Plate-Supply Impedance per Plate† .....	75	-	ohms
Min. Filter-Input Choke .....	-	6	henries
DC Output Current .....	100	100	ma

† When a filter capacitor larger than 40  $\mu$ f is used, it may be necessary to use more plate-supply impedance than the minimum value shown to limit the peak plate current to the rated value.

**HIGH-MU TRIODE—  
SHARP-CUTOFF PENTODE**

Miniature type used in a wide variety of applications in television receivers employing series-connected heater strings. The pentode unit is used as an if amplifier, video amplifier,

**8AW8-A**

agc amplifier, or reactance tube. The triode unit is used in low-frequency oscillator, sync-separator, sync-clipper, and phase-splitter circuits. Outline 14, OUTLINES SECTION. Heater volts (ac/dc), 8.4; amperes, 0.45; warm-up time (average), 11 seconds. For definition of heater warm-up time and method for determining it, see type 6CG7. Except for heater rating, type 8AW8-A is identical with miniature type 6AW8-A.

**MEDIUM-MU TWIN TRIODE**

Miniature type used as vertical deflection oscillator and horizontal deflection oscillator in television receivers employing series-connected heater strings. Outline 14, OUTLINES SECTION.

**8CG7**

Heater volts (ac/dc), 8.4; amperes, 0.45; warm-up time (average), 11 seconds. For definition of heater warm-up time and method for determining it, see type 6CG7. Except for heater rating, type 8CG7 is identical with miniature type 6CG7.

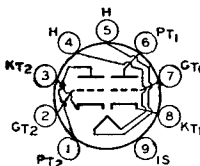
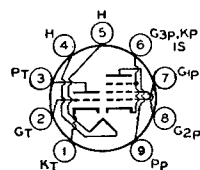

8CM7

MEDIUM-MU DUAL TRIODE

Miniature type used as vertical deflection oscillator and vertical deflection amplifier in television receivers employing series-connected heater strings. Outline 14, OUTLINES SECTION.

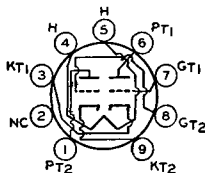

Heater volts (ac/dc), 8.4; amperes, 0.45; warm-up time (average), 11 seconds. For definition of heater warm-up time and method for determining it, see type 6CG7. Except for heater rating, type 8CM7 is identical with miniature type 6CM7.

POWER TRIODE

Glass type used as an audio-frequency amplifier. Outline 52, OUTLINES SECTION. Tube requires four-contact socket and should be operated in vertical position with base down. Filament volts (ac/dc), 7.5; amperes, 1.25. Typical operation as class A<sub>1</sub> af power amplifier: plate volts, 425 max; grid volts, -40; peak af grid volts, 35; plate ma., 18; plate resistance,

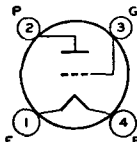

10

5000 ohms; transconductance, 1600 μmhos; load resistance, 10200 ohms; undistorted output watts, 1.6. This is a DISCONTINUED type listed for reference only.

DETECTOR AMPLIFIER

Glass types used as detectors and amplifiers in battery-operated receivers. Filament volts (dc), 1.1; amperes, 0.25. Typical operation as class A<sub>1</sub> amplifier: plate volts, 135 max; grid volts, -10.5; plate resistance, 15500 ohms; transconductance, 440 μmhos; plate ma., 8. These are DISCONTINUED types listed for reference only.

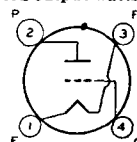

11

12

POWER PENTODE

Glass type used as output amplifier in ac/dc radio receivers. Outline 34 or 35, OUTLINES SECTION. Heater volts (ac/dc), 12.6 in series heater arrangement and 6.3 in parallel arrangement; amperes, 0.3 (series), 0.6 (parallel). Typical operation as class A<sub>1</sub> amplifier: plate volts and grid-No.2 volts, 180 max; grid-No.1 volts, -25; plate ma., 45; grid-No.2 ma., 8; plate resistance, 35000 ohms; transconductance, 2400 μmhos; load resistance, 3300 ohms; output watts, 3.4. This is a DISCONTINUED type listed for reference only.

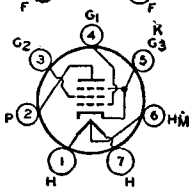

12A5

ohms; plate resistance, 10000 ohms; transconductance, 975 μmhos; cathode-bias resistor, 1175 ohms; plate ma., 9; grid-No.2 ma., 2.5; output watts, 0.55. Maximum ratings of rectifier unit with capacitor-input filter: ac plate volts (rms), 125; dc output ma., 30. This is a DISCONTINUED type listed for reference only.

RECTIFIER—POWER PENTODE

Glass type used as combined half-wave rectifier and power amplifier. Outline 39, OUTLINES SECTION. Tube requires small seven-contact (0.75-inch, pin-circle diameter) socket. Heater volts (ac/dc), 12.6; amperes, 0.3. Typical operation of pentode unit as class A<sub>1</sub> amplifier: plate volts and grid-No.2 volts, 185 max; grid-No.1 volts, -13.5; load resistance, 13500

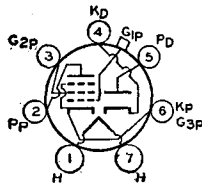

12A7

ohms; plate resistance, 10000 ohms; transconductance, 975 μmhos; cathode-bias resistor, 1175 ohms; plate ma., 9; grid-No.2 ma., 2.5; output watts, 0.55. Maximum ratings of rectifier unit with capacitor-input filter: ac plate volts (rms), 125; dc output ma., 30. This is a DISCONTINUED type listed for reference only.

PENTAGRID CONVERTER

Glass octal type used as converter in ac/dc receivers. Outline 24, OUTLINES SECTION. Heater volts (ac/dc), 12.6; amperes, 0.15. Except for heater rating, this type is identical with glass-octal type 6A8-GT. Type 12A8-GT is used principally for renewal purposes.

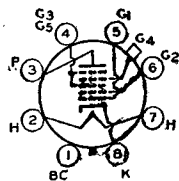

12A8-GT

## BEAM POWER TUBE

Miniature type used in the output stage of automobile radio receivers operating from a 12-volt storage battery. Outline 14, OUTLINES SECTION. Equipment using this type

# 12AB5

should be designed so that 90 per cent of the design-center maximum values of plate voltage, grid-No.2 voltage, plate dissipation, and grid-No.2 input is never exceeded for a battery potential of 13.2 volts. Tube requires miniature nine-contact socket and may be mounted in any position.

HEATER-VOLTAGE RANGE (AC/DC) *	10.0 to 15.9	volts
HEATER CURRENT (Approx.) at 12.6 volts	0.2	ampere
DIRECT INTERELECTRODE CAPACITANCES:		
Grid No.1 to Plate	0.7 max	$\mu\text{f}$
Grid No.1 to Cathode, Heater, Grid No.2, and Grid No.3	8	$\mu\text{f}$
Plate to Cathode, Heater, Grid No.2, and Grid No.3	8.5	$\mu\text{f}$

\* This voltage range is on an absolute basis. For longest life, it is recommended that the heater be operated within the voltage range of 11 to 14 volts.

### CLASS A<sub>1</sub> AMPLIFIER

#### Maximum Ratings:

PLATE VOLTAGE	315 max	volts
GRID-NO.2 (SCREEN-GRID) VOLTAGE	285 max	volts
PLATE DISSIPATION	12 max	watts
GRID-NO.2 INPUT	2 max	watts
PEAK HEATER-CATHODE VOLTAGE:		
Heater negative with respect to cathode	90 max	volts
Heater positive with respect to cathode	90 max	volts
BULB TEMPERATURE (At hottest point)	250 max	$^{\circ}\text{C}$

#### Typical Operation with 12.6 Volts on Heater:

Plate Supply Voltage	250	250	volts
Grid-No.2 Supply Voltage	200	250	volts
Grid-No.1 Voltage		-12.5	volts
Cathode-Bias Resistor	270		ohms
Peak AF Grid-No.2 Voltage	10.5	12.5	volts
Zero-Signal Plate Current	33.5	45	ma
Maximum-Signal Plate Current	36	47	ma
Zero-Signal Grid-No.2 Current (Approx.)	1.6	4.5	ma
Maximum-Signal Grid-No.2 Current (Approx.)	3.2	7	ma
Plate Resistance (Approx.)	75000	50000	ohms
Transconductance	4000	4100	$\mu\text{mhos}$
Load Resistance	6000	5000	ohms
Total Harmonic Distortion	8	8	per cent
Maximum-Signal Power Output	3.3	4.5	watts

#### AVERAGE CHARACTERISTICS

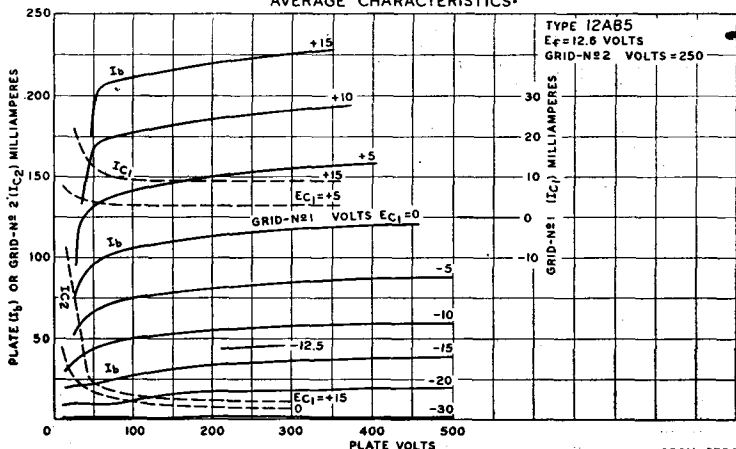

### Maximum Circuit Values:

Grid-No.1-Circuit Resistance:		
For fixed-bias operation.....	0.1 max	megohm
For cathode-bias operation.....	0.5 max	megohm

### PUSH-PULL CLASS AB<sub>1</sub> AMPLIFIER

#### Maximum Ratings:

(Same as for single-tube class A<sub>1</sub> amplifier)

#### Typical Operation with 12.6 Volts on Heater (Values are for two tubes):

Plate Voltage.....	250	volts
Grid-No.2 Voltage.....	250	volts
Grid-No.1 Voltage.....	-15	volts
Peak AF Grid-No.1-to-Grid-No.1 Voltage.....	30	volts
Zero-Signal Plate Current.....	70	ma
Maximum-Signal Plate Current.....	79	ma
Zero-Signal Grid-No.2 Current (Approx.).....	5	ma
Maximum-Signal Grid-No.2 Current (Approx.).....	13	ma
Effective Load Resistance (Plate to plate).....	10000	ohms
Total Harmonic Distortion.....	5	per cent
Maximum-Signal Power Output.....	10	watts

#### Maximum Circuit Values:

Grid-No.1-Circuit Resistance:		
For fixed-bias operation.....	0.1 max	megohm
For cathode-bias operation.....	0.5 max	megohm

## 12AD6

### PENTAGRID CONVERTER

Miniature type used as combined oscillator and mixer in automobile radio receivers operating from a 12-volt storage battery. Outline 11, OUTLINES SECTION. Equipment using

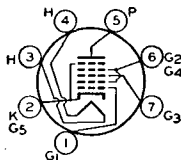

this type should be designed so that 90 per cent of the maximum values of plate voltage, grid-No.2 voltage, plate dissipation, and grid-No.2 input is never exceeded for a battery potential of 13.2 volts. Tube requires miniature seven-contact socket and may be mounted in any position.

HEATER-VOLTAGE RANGE (AC/DC) *.....	10.0 to 15.9	volts
HEATER CURRENT (Approx.) at 12.5 volts.....	0.15	ampere

DIRECT INTERELECTRODE CAPACITANCES:	Without External Shield	With External Shield <sup>□</sup>	
Grid No.3 to All Other Electrodes (RF Input).....	8	8	μf
Plate to All Other Electrodes (Mixer Output).....	13	8	μf
Grid No.1 to All Other Electrodes (Oscillator Input).....	5.5	5.5	μf
Cathode and Grid No.5 to All Other Electrodes except Grid No.1 (Oscillator Output).....	20	15	μf
Grid No.3 to Plate.....	0.25 max	0.3 max	μf
Grid No.3 to Grid No.1.....	0.15 max	0.15 max	μf
Grid No.1 to Cathode and Grid No.5.....	3	3	μf
Grid No.1 to Plate.....	0.05 max	0.1 max	μf

\* This voltage range is on an absolute basis. For longest life, it is recommended that the heater be operated within the voltage range of 11 to 14 volts.

□ External shield connected to cathode.

### CONVERTER SERVICE

#### Maximum Ratings:

PLATE VOLTAGE.....	30 max	volts
GRIDS-NO.2-AND-NO.4 SUPPLY VOLTAGE.....	30 max	volts
GRIDS-NO.2-AND-NO.4 VOLTAGE.....	30 max	volts
GRID-NO.3 VOLTAGE:		
Negative bias value.....	-30 max	volts
Positive bias value.....	0 max	volts
TOTAL CATHODE CURRENT.....	20 max	ma
PEAK HEATER-CATHODE VOLTAGE:		
Heater negative with respect to cathode.....	30 max	volts
Heater positive with respect to cathode.....	30 max	volts

## Typical Operation with 12.6 Volts on Heater (Self-Excitation):

Plate Voltage.....	12.6	volts
Grids-No.2-and-No.4 Voltage.....	12.6	volts
Grid-No.3 (Control-Grid) Voltage.....	0	volts
Grid-No.1 (Oscillator-Grid) Voltage (rms).....	1.6	volts
Grid-No.3 Resistor.....	2.2	megohms
Grid-No.1 Resistor.....	33000	ohms
Plate Resistance (Approx.).....	1.0	megohm
Conversion Transconductance.....	260	$\mu$ mhos
Grid-No.3 Voltage (Approx.) for conversion transconductance of 5 $\mu$ mhos.....	-2.2	volts
Grid-No.3 Voltage (Approx.) for conversion transconductance of 20 $\mu$ mhos.....	-1.8	volts
Plate Current.....	0.45	ma
Grids-No.2-and-No.4 Current.....	1.5	ma
Grid-No.1 Current.....	0.05	ma
Total Cathode Current.....	2	ma

### Maximum Circuit Value:

Grid-No.3-Circuit Resistance.....	10 maz	megohms
-----------------------------------	--------	---------

NOTE: The transconductance between grid No.1 and grids No.2 and No.4 connected to plate (not oscillating) is approximately 3800  $\mu$ mhos under the following conditions: heater at 12.6 volts, grids No.2 and No.4 and plate at 12.6 volts, grids No.1 and No.3 at 0 volts. Under the same conditions, the cathode current is 5 ma and the amplification factor is 9.

### OPERATION CHARACTERISTICS GAIN WITH SELF EXCITATION ( $g_c$ WITH SEPARATE EXCITATION)

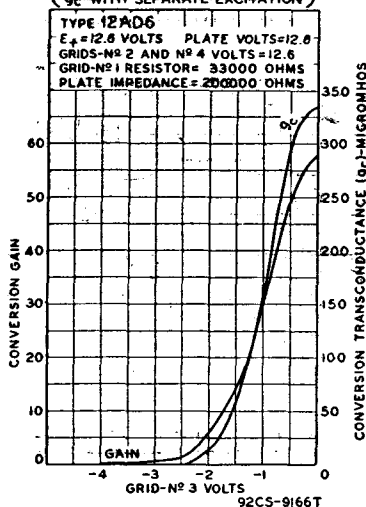

## TWIN DIODE— MEDIUM-MU TRIODE

Miniature type used as combined detector and af voltage amplifier in automobile radio receivers operating from a 12-volt storage battery. Outline 11, OUTLINES SECTION. Equip-

# 12AE6

ment using this type should be designed so that 90 per cent of the maximum value of plate voltage is never exceeded for a battery potential of 13.2 volts. Tube requires miniature seven-contact socket and may be mounted in any position.

HEATER-VOLTAGE RANGE (AC/DC).....	10.0 to 15.9	volts
HEATER CURRENT (Approx.) at 12.6 volts.....	0.15	ampere
DIRECT INTERELECTRODE CAPACITANCES:		
Triode Grid to Triode Plate.....	2.0	$\mu$ mf
Triode Grid to Cathode and Heater.....	1.8	$\mu$ mf
Triode Plate to Cathode and Heater.....	1.1	$\mu$ mf
Plate of Diode Unit No.1 to Plate of Diode Unit No.2.....	0.9	$\mu$ mf

\* This voltage range is on an absolute basis. For longest life, it is recommended that the heater be operated within the voltage range of 11 to 14 volts.

## TRIODE UNIT AS CLASS A<sub>1</sub> AMPLIFIER

### Maximum Ratings:

PLATE VOLTAGE .....	30 <i>max</i>	volts
TOTAL CATHODE CURRENT .....	20 <i>max</i>	ma
<b>PEAK HEATER-CATHODE VOLTAGE:</b>		
Heater negative with respect to cathode .....	30 <i>max</i>	volts
Heater positive with respect to cathode .....	30 <i>max</i>	volts

### Characteristics with 12.6 Volts on Heater:

Plate Voltage .....	12.6	volts
Grid Voltage .....	0	volts
Plate Resistance .....	15000	ohms
Transconductance .....	1000	$\mu$ hos
Amplification Factor .....	15	
Plate Current .....	0.75	ma

### Maximum Circuit Value:

Grid-Circuit Resistance .....	10 <i>max</i>	megohms
-------------------------------	---------------	---------

## DIODE UNITS

### Maximum Rating:

PLATE CURRENT (Each Unit) .....	1 <i>max</i>	ma
---------------------------------	--------------	----

AVERAGE CHARACTERISTICS

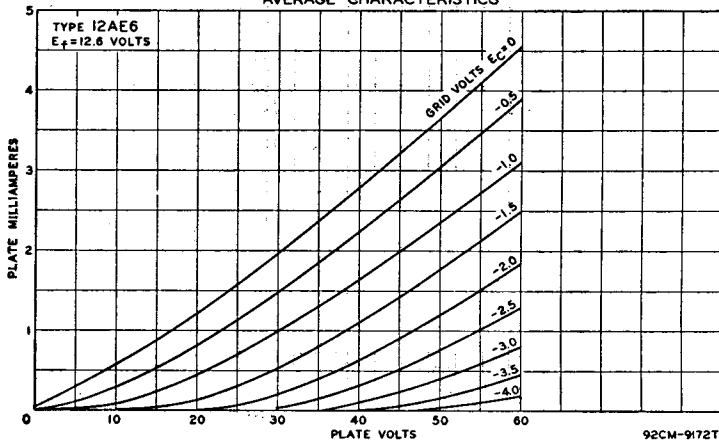

## SHARP-CUTOFF PENTODE

# 12AF6

Miniature type used as if and rf amplifier in automobile radio receivers operating from a 12-volt storage battery. Outline 11, OUTLINES SECTION. Equipment using this type

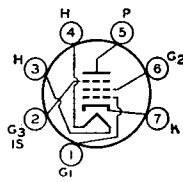

should be designed so that 90 per cent of the maximum values of plate voltage and grid-No.2 voltage is never exceeded for a battery potential of 13.2 volts. Tube requires miniature seven-contact socket and may be mounted in any position.

HEATER-VOLTAGE RANGE (AC/DC) .....	10.0 to 15.9	volts
HEATER CURRENT (Approx.) at 12.6 volts .....	0.15	amperes
<b>DIRECT INTERELECTRODE CAPACITANCES:</b>		
Grid No.1 to Plate .....	0.006 <i>max</i>	$\mu$ f
Grid No.1 to Cathode, Heater, Grid No.2, Grid No.3, and Internal Shield .....	5.5	$\mu$ f
Plate to Cathode, Heater, Grid No.2, Grid No.3, and Internal Shield .....	4.8	$\mu$ f

\* This voltage range is on an absolute basis. For longest life, it is recommended that the heater be operated within the voltage range of 11 to 14 volts.

## CLASS A<sub>1</sub> AMPLIFIER

### Maximum Ratings:

PLATE VOLTAGE.....	16 max	volts
GRID-NO.2 (SCREEN-GRID) VOLTAGE.....	16 max	volts
GRID-NO.1 (CONTROL-GRID) VOLTAGE:		
Positive bias value.....	0 max	volts
PEAK HEATER-CATHODE VOLTAGE:		
Heater negative with respect to cathode.....	16 max	volts
Heater positive with respect to cathode.....	16 max	volts

### Typical Operation with 12.6 Volts on Heater:

Plate Voltage.....	12.6	volts
Grid-No.3 (Suppressor-Grid) Voltage.....	0	volts
Grid-No.2 Voltage.....	12.6	volts
Grid-No.1 Resistor.....	2.2	megohms
Plate Resistance (Approx.).....	0.3	megohm
Transconductance.....	1250	$\mu$ mhos
Grid-No.1 Voltage (Approx.) for transconductance of 40 $\mu$ mhos.....	-2.7	volts
Plate Current.....	0.8	ma
Grid-No.2 Current.....	0.8	ma

### Maximum Circuit Value:

Grid-No.1-Circuit Resistance.....	2.2	megohms
-----------------------------------	-----	---------

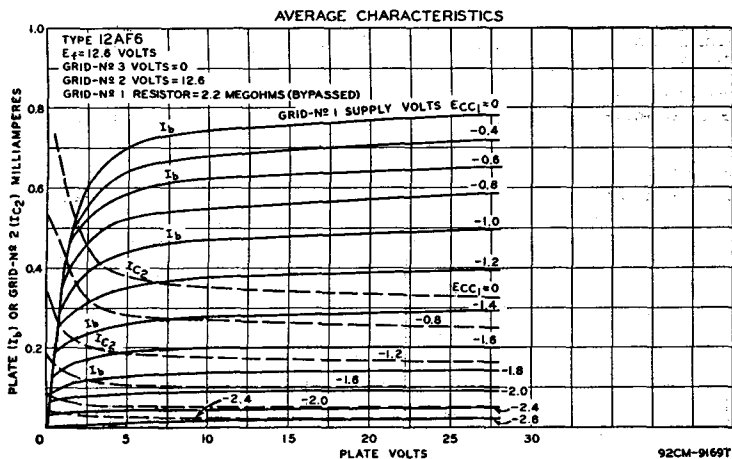

## MEDIUM-MU TWIN TRIODE

Glass octal tube used as audio amplifier in radio equipment. Outline 23, OUTLINES SECTION, except over-all length is 3-1/16 max inches and seated length is 2-1/2 inches. Tube requires octal socket. Heater volts (ac/dc), 12.6; amperes, 0.15. Typical operation as class A<sub>1</sub> amplifier: plate volts, 180 max; grid volts, -6.5; amplification factor, 16; transconductance, 1900  $\mu$ mhos; plate resistance, 8400 ohms; plate ma., 7.6; grid volts for plate current of 10  $\mu$ a, -16. This type is used principally for renewal purposes.

# 12AH7-GT

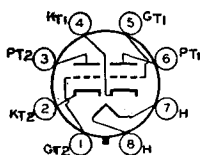

## TWIN DIODE— MEDIUM-MU TRIODE

Miniature type used as combined detector and af voltage amplifier in automobile radio receivers operating from a 12-volt storage battery. Outline 11, OUTLINES SECTION. Equip-

# 12AJ6

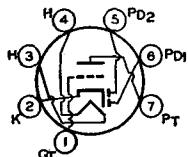

ment using this type should be designed so that 90 per cent of the maximum value of plate voltage is never exceeded for a battery potential of 13.2 volts. Tube requires miniature seven-contact socket and may be mounted in any position.

HEATER-VOLTAGE RANGE (AC/DC)*	10.0 to 15.9	volts
HEATER CURRENT (Approx.) at 12.6 volts	0.15	ampere
DIRECT INTERELECTRODE CAPACITANCES:		
Triode Grid to Triode Plate	2.0	$\mu\text{f}$
Triode Grid to Cathode and Heater	2.2	$\mu\text{f}$
Triode Plate to Cathode and Heater	0.8	$\mu\text{f}$
Plate of Diode Unit No.1 to Plate of Diode Unit No.2	0.9	$\mu\text{f}$

\* This voltage range is on an absolute basis. For longest life, it is recommended that the heater be operated within the voltage range of 11 to 14 volts.

### TRIODE UNIT AS CLASS A<sub>1</sub> AMPLIFIER

#### Maximum Ratings:

PLATE VOLTAGE	30 max	volts
TOTAL CATHODE CURRENT	20 max	ma
PEAK HEATER-CATHODE VOLTAGE:		
Heater negative with respect to cathode	30 max	volts
Heater positive with respect to cathode	30 max	volts

#### Typical Operation with 12.6 Volts on Heater:

Plate Voltage	12.6	volts
Grid Voltage	0	volts
Plate Resistance	45000	ohms
Transconductance	1200	$\mu\text{mhos}$
Amplification Factor	55	
Plate Current	0.75	ma

#### Maximum Circuit Value:

Grid-Circuit Resistance	10 max	megohms
-------------------------	--------	---------

### DIODE UNITS

#### Maximum Rating:

PLATE CURRENT (Each Unit)	1 max	ma
---------------------------	-------	----

### AVERAGE CHARACTERISTICS

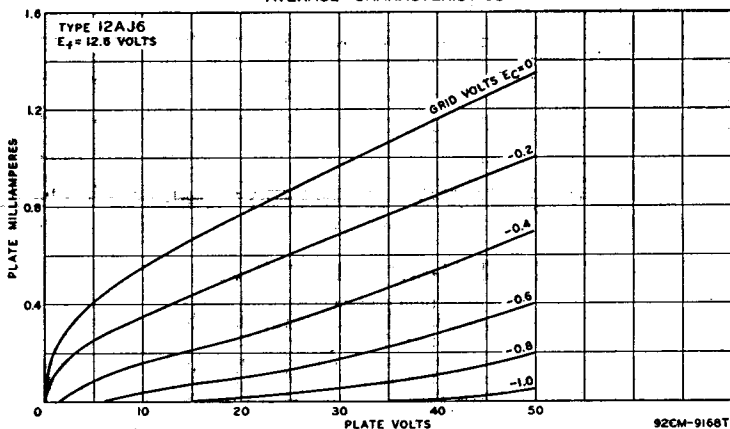

### TWIN DIODE

Miniature, high-perveance type used as detector in FM and television circuits. It is especially useful as a ratio detector in ac/dc FM receivers. Outline 9, OUTLINES SECTION. Heater volts (ac/dc), 12.6; amperes, 0.15. Except for heater rating, this type is identical with miniature type 6AL5.

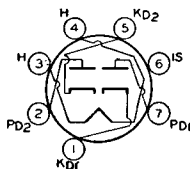

# 12AL5



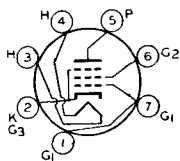

**BEAM POWER TUBE**

**12AQ5**

Miniature type used as output amplifier primarily in automobile radio receivers operating from a 12-volt storage battery. Outline 13, OUTLINES SECTION. Heater volts

ac/dc), 12.6; amperes, 0.225. Except for heater rating, this type is identical with miniature type 6AQ5. Within its maximum ratings, the performance of the 12AQ5 is equivalent to that of the larger type 12V6-GT.

**TWIN DIODE—  
HIGH-MU TRIODE**

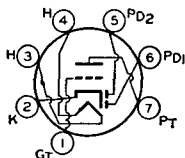

**12AT6**

Miniature type used as a combined detector, amplifier, and avc tube in compact ac/dc radio receivers. Outline 11, OUTLINES SECTION. Heater volts (ac/dc), 12.6; amperes, 0.15. Except for the heater rating, this type is identical with miniature type 6AT6.

**HIGH-MU TWIN TRIODE**

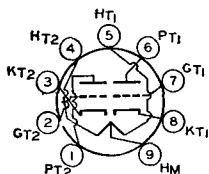

**12AT7**

Miniature type used as cathode-drive amplifier or frequency converter in the FM and television broadcast bands. Outline 12 OUTLINES SECTION. Tube requires miniature nine-

contact socket and may be mounted in any position. Each triode unit is independent of the other except for the common heater.

<b>HEATER ARRANGEMENT</b> .....	<i>Series</i>	<i>Parallel</i>	
<b>HEATER VOLTAGE (AC/DC)</b> .....	12.6	6.3	volts
<b>HEATER CURRENT</b> .....	0.15	0.3	ampere
<b>DIRECT INTERELECTRODE CAPACITANCES:</b>			
Grid to Grid.....		0.005 max	$\mu\mu\text{f}$
Plate to Plate.....		0.4 max	$\mu\mu\text{f}$
Grid to Plate (Each Unit).....		1.5	$\mu\mu\text{f}$
Grid to Cathode and Heater (Each Unit).....		2.2	$\mu\mu\text{f}$
Plate to Cathode and Heater (Unit No.1).....		0.5	$\mu\mu\text{f}$
Plate to Cathode and Heater (Unit No.2).....		0.4	$\mu\mu\text{f}$
Heater to Cathode (Each Unit).....		2.4	$\mu\mu\text{f}$
Plate to Cathode (Each Unit).....		0.2	$\mu\mu\text{f}$
Cathode to Heater and Grid (Each Unit).....		4.6	$\mu\mu\text{f}$
Plate to Heater and Grid (Each Unit).....		1.8	$\mu\mu\text{f}$

**Maximum Ratings:**

**CLASS A<sub>1</sub> AMPLIFIER (Each Unit)**

<b>PLATE VOLTAGE</b> .....	300 max	volts
<b>GRID VOLTAGE, Negative Bias Value</b> .....	-50 max	volts
<b>PLATE DISSIPATION</b> .....	2.5 max	watts
<b>PEAK HEATER-CATHODE VOLTAGE:</b>		
Heater negative with respect to cathode.....	90 max	volts
Heater positive with respect to cathode.....	90 max	volts

**Characteristics:**

<b>Plate Supply Voltage</b> .....	100	250	volts
<b>Cathode-Bias Resistor</b> .....	270	200	ohms
<b>Amplification Factor</b> .....	60	60	
<b>Plate Resistance (Approx.)</b> .....	15000	10900	ohms
<b>Transconductance</b> .....	4000	5500	$\mu\text{mhos}$
<b>Grid Voltage (Approx.) for plate current of 10 <math>\mu\text{a}</math>.</b> .....	-5	-12	volts
<b>Plate Current</b> .....	3.7	10	ma

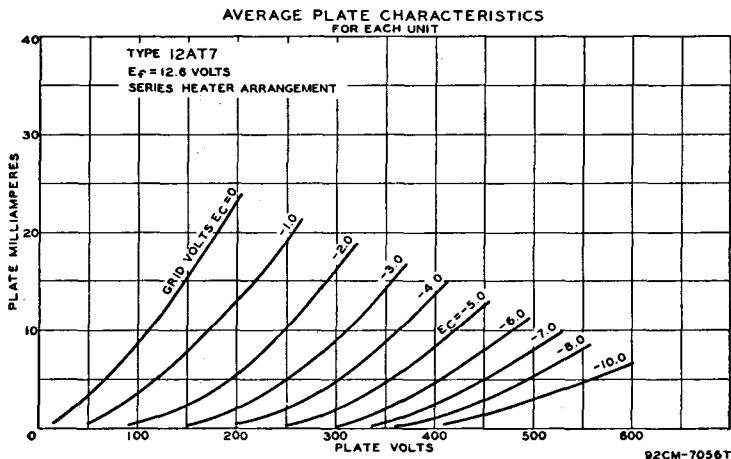

## 12AU6

### SHARP-CUTOFF PENTODE

Miniature type used in compact ac/dc radio equipment as an rf amplifier especially in high-frequency, wide-band applications. Outline 11, OUTLINES SECTION. Heater volts (ac/dc), 12.6; amperes, 0.15. Except for heater rating, this type is identical with miniature type 6AU6.

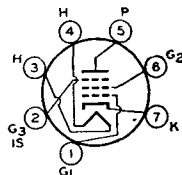

## 12AU7

### MEDIUM-MU TWIN TRIODE

Miniature type used as phase inverter or amplifier in ac/dc radio equipment and in many diversified applications such as multivibrators or oscillators in industrial control devices.

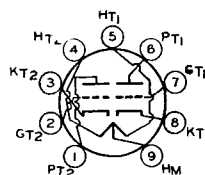

Also used as combined vertical oscillator and vertical deflection amplifier, and as horizontal deflection oscillator, in television receivers. Outline 12, OUTLINES SECTION. Tube requires miniature nine-contact socket and may be mounted in any position. Its characteristics are similar to glass-octal type 6SN7-GT. Each triode unit is independent of the other except for the common heater. For typical operation as a resistance-coupled amplifier, refer to Chart 10, RESISTANCE COUPLED AMPLIFIER SECTION. For ratings as vertical oscillator and vertical deflection amplifier, and as horizontal deflection oscillator, see type 7AU7.

HEATER ARRANGEMENT	Series	Parallel	
HEATER VOLTAGE (AC/DC) .....	12.6	6.3	volts
HEATER CURRENT .....	0.15	0.3	ampere
DIRECT INTERELECTRODE CAPACITANCES (Approx.):			
	Unit No. 1	Unit No. 2	
Grid to Plate .....	1.5	1.5	μf
Grid to Cathode and Heater .....	1.6	1.6	μf
Plate to Cathode and Heater .....	0.4	0.32	μf

#### Maximum Ratings:

#### CLASS A<sub>1</sub> AMPLIFIER (Each Unit)

PLATE VOLTAGE .....	300 max	volts
PLATE DISSIPATION .....	2.75 max	watts
CATHODE CURRENT .....	20 max	ma

**GRID VOLTAGE:**

Negative bias value.....	50 max	volts
Positive bias value.....	0 max	volts
<b>PEAK HEATER-CATHODE VOLTAGE:</b>		
Heater negative with respect to cathode.....	200 max	volts
Heater positive with respect to cathode.....	200 max	volts

• The dc component must not exceed 100 volts.

**Characteristics:**

Plate Voltage.....	100	250	volts
Grid Voltage.....	0	-8.5	volts
Amplification Factor.....	20	17	
Plate Resistance (Approx.).....	6500	7700	ohms
Transconductance.....	3100	2200	$\mu$ mhos
Grid Voltage (Approx.) for plate current of 10 $\mu$ a.....	-	-24	volts
Plate Current.....	11.8	10.5	ma

**Maximum Circuit Values (For maximum rated conditions):**

Grid-Circuit Resistance:		
For fixed-bias operation.....	0.25 max	megohm
For cathode-bias operation.....	1.0 max	megohm

**AVERAGE PLATE CHARACTERISTICS  
EACH TRIODE UNIT**

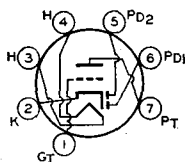
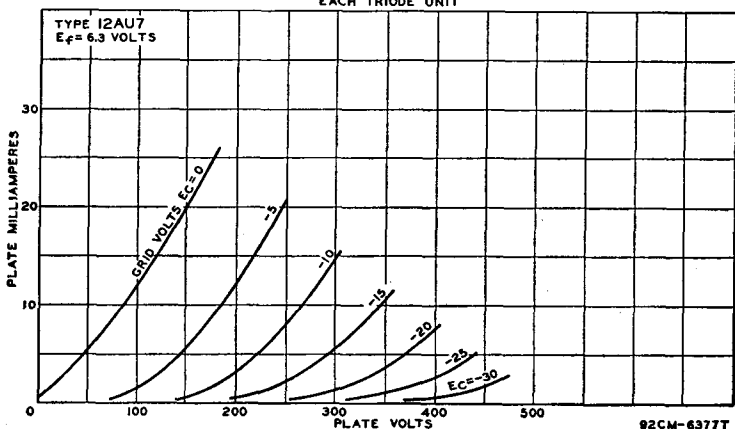

## TWIN DIODE— HIGH-MU TRIODE

Miniature type used as combined detector, amplifier, and avc tube in automobile and ac-operated receivers. Outline 11, OUTLINES SECTION.

# 12AV6

Heater volts (ac/dc), 12.6; amperes, 0.15. Except for heater rating, this type is identical with miniature type 6AV6.

## MEDIUM-MU TWIN TRIODE

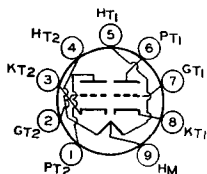

Miniature type used as frequency converter in vhf tuners of television receivers. Also used as rf amplifier, oscillator, or mixer. Outline 12, OUTLINES SECTION. Tube requires miniature nine-contact socket and may be mounted in any position. Each triode unit is independent of the other except for the common heater. Heater volts (ac/dc), 12.6 in series arrangement, 6.3 in parallel arrangement; amperes,

# 12AV7

0.225 (series), 0.45 (parallel). Maximum ratings as class A<sub>1</sub> amplifier (each unit): plate volts, 300 max; negative dc grid volts, 50 max; plate dissipation, 2.7 max watts; peak heater-cathode volts, 90 max. This type is used principally for renewal purposes.

## CLASS A<sub>1</sub> AMPLIFIER (Each Unit)

### Characteristics:

Plate Supply Voltage.....	100	150	volts
Cathode-Bias Resistor.....	120	56	ohms
Amplification Factor.....	37	41	
Plate Resistance (Approx.).....	6100	4800	ohms
Transconductance.....	6100	8500	mhos
Plate Current.....	9	18	ma
Grid Voltage (Approx.) for plate current of 10 $\mu$ a.....	-9	-12	volts

## SHARP-CUTOFF PENTODE

Miniature type used as an rf or if amplifier up to 400 megacycles in compact ac/dc FM receivers. Outline 11, OUTLINES SECTION. Tube requires miniature seven-contact socket and may be mounted in any position. Heater volts (ac/dc), 12.6; amperes, 0.15. Except for heater ratings and terminal connections, this type is identical with miniature type 6AG5. Type 12AW6 is used principally for renewal purposes.

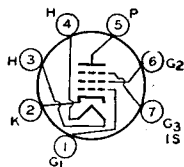

## 12AW6

## 12AX4-GT

## HALF-WAVE VACUUM RECTIFIER

Glass octal types used as damper tubes in horizontal deflection circuits of television receivers. Type 12AX4-GTA has a controlled heater warm-up time for use in series-connected heater

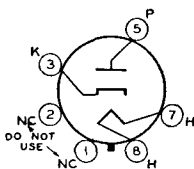

## 12AX4-GTA

strings. Outline 22, OUTLINES SECTION. Tubes require octal socket and may be mounted in any position. These types may be supplied with pin No.1 omitted. Heater volts (ac/dc), 12.6; amperes, 0.6; warm-up time (average) for 12AX4-GTA, 11 seconds. For definition of heater warm-up time and method for determining it, see type 6CG7. Except for heater rating, these types are identical with glass octal type 6AX4-GT. Type 12AX4-GT is a DISCONTINUED type listed for reference only.

## HIGH-MU TWIN TRIODE

Miniature type used as phase inverter or resistance-coupled amplifier in radio equipment and in many diversified applications such as multivibrators or oscillators in industrial control

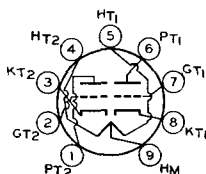

## 12AX7

devices. Outline 12, OUTLINES SECTION. Tube requires miniature nine-contact socket and may be mounted in any position. Its characteristics are similar to glass-octal type 6SL7-GT. Each triode unit is independent of the other except for the common heater. For characteristics and curves, refer to type 6AV6. For typical operation as a resistance-coupled amplifier, refer to Chart 20, RESISTANCE-COUPLED AMPLIFIER SECTION.

<b>HEATER ARRANGEMENT</b>	<i>Series</i>	<i>Parallel</i>	
HEATER VOLTAGE (AC/DC).....	12.6	6.3	volts
HEATER CURRENT.....	0.15	0.3	ampere
<b>DIRECT INTERELECTRODE CAPACITANCES:</b>			
	<i>Unit No. 1</i>	<i>Unit No. 2</i>	
Grid to Plate.....	1.7	1.7	$\mu$ f
Grid to Cathode and Heater.....	1.6	1.6	$\mu$ f
Plate to Cathode and Heater.....	0.46	0.34	$\mu$ f

### Maximum Ratings:

### CLASS A<sub>1</sub> AMPLIFIER (Each Unit)

PLATE VOLTAGE.....	300 max	volts
PLATE DISSIPATION.....	1 max	watt
<b>GRID VOLTAGE:</b>		
Negative bias value.....	50 max	volts
Positive bias value.....	0 max	volts
<b>PEAK HEATER-CATHODE VOLTAGE:</b>		
Heater negative with respect to cathode.....	180 max	volts
Heater positive with respect to cathode.....	180 max	volts

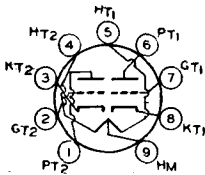

**HIGH-MU TWIN TRIODE**

**12AZ7**

Miniature type used as combined oscillator and mixer tube in vhf tuners of television broadcast bands. Outline 12, OUTLINES SECTION. Tube requires miniature nine-contact socket and may be mounted in any position. Each triode unit is independent of the other except for the common heater.

HEATER ARRANGEMENT	Series	Parallel	
HEATER VOLTAGE (AC/DC)	12.6	6.3	volts
HEATER CURRENT	0.225	0.450	amperes

**CLASS A<sub>1</sub> AMPLIFIER (Each Unit)**

**Maximum Ratings:**

PLATE VOLTAGE	300 max	volts
GRID VOLTAGE, Negative Bias Value	-50 max	volts
PLATE DISSIPATION	2.5 max	watts
<b>PEAK HEATER-CATHODE VOLTAGE:</b>		
Heater negative with respect to cathode	90 max	volts
Heater positive with respect to cathode	90 max	volts

**Characteristics:**

Plate Supply Voltage	100	250	volts
Cathode-Bias Resistor	270	200	ohms
Amplification Factor	60	60	
Plate Resistance (Approx.)	15000	10900	ohms
Transconductance	4000	5500	μmhos
Grid Voltage (Approx.) for plate current of 10 μa	-5	-12	volts
Plate Current	3.7	10	ma

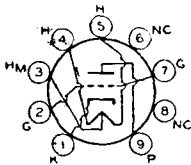

**LOW-MU TRIODE**

**12B4-A**

Miniature type having high perveance used as vertical deflection amplifier in television receivers employing series-connected heater strings. Outline 14, OUTLINES SECTION. Tube requires miniature nine-contact socket and may be mounted in any position.

HEATER ARRANGEMENT	Series	Parallel	
HEATER VOLTAGE (AC/DC)	12.6	6.3	volts
HEATER CURRENT	0.3	0.6	amperes
HEATER WARM-UP TIME (Average)*	-	11	seconds

\*For definition of heater warm-up time and method for determining it, see type 6CG7.

**CLASS A<sub>1</sub> AMPLIFIER**

**Maximum Ratings:**

PLATE VOLTAGE	550 max	volts
GRID VOLTAGE, Negative Bias Value	-50 max	volts
PLATE DISSIPATION	5.5 max	watts
<b>PEAK HEATER-CATHODE VOLTAGE:</b>		
Heater negative with respect to cathode	200 max	volts
Heater positive with respect to cathode	200 max	volts

**Characteristics:**

Plate Voltage	150	volts
Grid Voltage	-17.5	volts
Amplification Factor	6.5	
Plate Resistance (Approx.)	1030	ohms
Transconductance	6300	μmhos
Plate Current	34	ma
Grid Voltage (Approx.) for plate current of 200 μa	-32	volts
Plate Current for grid voltage of -23 volts	9.6	ma

## Maximum Circuit Values:

Grid-Circuit Resistance:		
For fixed-bias operation.....	0.47 max	megohm
For cathode-bias operation.....	2.2 max	megohms

## VERTICAL DEFLECTION AMPLIFIER

*For operation in a 525-line, 30-frame system*

### Maximum Ratings:

DC PLATE VOLTAGE.....	550 max	volts
PEAK POSITIVE-PULSE PLATE VOLTAGE# (Absolute Maximum).....	1000†max	volts
PEAK NEGATIVE-PULSE GRID VOLTAGE.....	-250 max	volts
CATHODE CURRENT:		
Peak.....	105 max	ma
Average.....	30 max	ma
PLATE DISSIPATION.....	5.5 max	watts
PEAK HEATER-CATHODE VOLTAGE:		
Heater negative with respect to cathode.....	200 max	volts
Heater positive with respect to cathode.....	200°max	volts

### Maximum Circuit Value:

Grid-Circuit Resistance:	
For cathode-bias operation.....	2.2 max megohms

# The duration of the voltage pulse must not exceed 15 per cent of one vertical scanning cycle. In a 525-line, 30-frame system, 15 per cent of one vertical scanning cycle is 2.5 milliseconds.

† Under no circumstances should this absolute value be exceeded.

° The dc component must not exceed 100 volts.

## TRIODE—PENTODE

Glass octal type used as combined detector and rf or if amplifier in ac/dc receivers. Heater volts (ac/dc), 12.6; amperes, 0.3. Characteristics of triode unit: plate volts, 90; grid volts, 0; amplification factor, 90; plate resistance, 37000 ohms; transconductance, 2400  $\mu$ mhos; plate ma., 2.8. Characteristics of pentode unit: plate volts, 90; grid-No.2 volts, 90; grid-No.1 volts,

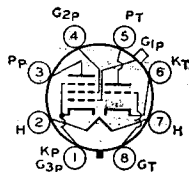

-3; plate resistance, 200000 ohms; transconductance, 1800  $\mu$ mhos; grid-No.1 volts for transconductance of 2  $\mu$ mhos, -42.5; plate ma., 7; grid-No.2 ma., 2. This is a DISCONTINUED type listed for reference only.

## 12B8-GT

## REMOTE-CUTOFF PENTODE

Miniature type used as rf amplifier in ac/dc standard broadcast receivers, in FM receivers, and in other wide-band, high-frequency applications. Outline 11, OUTLINES SEC-

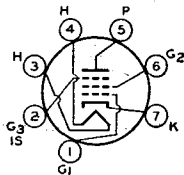

TION. Heater volts (ac/dc), 12.6; amperes, 0.15. Except for heater ratings, this type is identical with miniature type 6BA6.

## 12BA6

## PENTAGRID CONVERTER

Miniature type used as converter in ac/dc superheterodyne circuits especially those for the FM broadcast band. Outline 14, OUTLINES SEC-

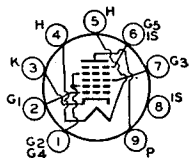

TION. Heater volts (ac/dc), 12.6; amperes, 0.15. Except for heater rating, this type is identical with miniature type 6BA7.

## 12BA7

## REMOTE-CUTOFF PENTODE

Miniature type used as rf or if amplifier in radio receivers. Outline 11, OUTLINES SECTION. Heater volts (ac/dc), 12.6; amperes, 0.15. Except for heater rating, this type is identical with miniature type 6BD6. Type 12BD6 is used principally for renewal purposes.

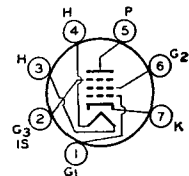

## 12BD6

**PENTAGRID CONVERTER**

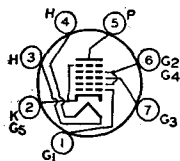

Miniature type used as converter in ac/dc receivers for both standard broadcast and FM bands. Outline 11, OUTLINES SECTION. Heater volts (ac/dc), 12.6; amperes, 0.15. Except for heater rating, this type is identical with miniature type 6BE6.

**12BE6**

**TWIN DIODE—  
MEDIUM-MU TRIODE**

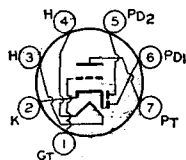

Miniature type used as combined detector, amplifier, and avc tube primarily in automobile radio receivers operating from a 12-volt storage battery. The triode unit is particularly

**12BF6**

useful as a driver for impedance- or transformer-coupled output stages in automobile receivers. It is equivalent in performance to metal type 12SR7. Outline 11, OUTLINES SECTION. Tube requires miniature seven-contact socket and may be mounted in any position. Heater volts (ac/dc), 12.6; amperes, 0.15. Except for heater rating, this type is identical with miniature type 6BF6.

**MEDIUM-MU TWIN TRIODE**

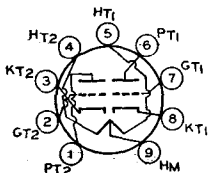

Miniature types used as combined vertical deflection amplifiers and vertical oscillators, and as horizontal deflection oscillators, in television receivers. Type 12BH7-A has a controlled

**12BH7  
12BH7-A**

heater warm-up time for use in series-connected heater strings. These types are also used in other applications including phase-inverter circuits and multivibrator circuits. Outline 14, OUTLINES SECTION. Tubes require miniature nine-contact socket and may be mounted in any position. Each triode unit is independent of the other except for the common heater. Type 12BH7 is a DISCONTINUED type listed for reference only.

<b>HEATER ARRANGEMENT</b>	<i>Series</i>	<i>Parallel</i>	
<b>HEATER VOLTAGE (AC/DC)</b> .....	12.6	6.3	volts
<b>HEATER CURRENT</b> .....	0.3	0.6	ampere
<b>HEATER WARM-UP TIME (Average)* for 12BH7-A</b> .....	—	11	seconds
<b>DIRECT INTERELECTRODE CAPACITANCES (Approx.):</b>			
	<i>Unit No.1</i>	<i>Unit No.2</i>	
<b>Grid to Plate</b> .....	2.6	2.6	μf
<b>Grid to Cathode and Heater</b> .....	3.2	3.2	μf
<b>Plate to Cathode and Heater</b> .....	0.5	0.4	μf
<b>Plate of Unit No.1 to Plate of Unit No.2</b> .....	0.8		μf

\* For definition of heater warm-up time and method for determining it, see type 6CG7.

**CLASS A<sub>1</sub> AMPLIFIER (Each Unit)**

**Maximum Ratings:**

<b>PLATE VOLTAGE</b> .....	300 max	volts
<b>GRID VOLTAGE:</b>		
Negative Bias Value.....	50 max	volts
Positive Bias Value.....	0 max	volts
<b>CATHODE CURRENT</b> .....	20 max	ma
<b>PLATE DISSIPATION</b> .....	3.5 max	watts
<b>PEAK HEATER-CATHODE VOLTAGE:</b>		
Heater negative with respect to cathode.....	200 max	volts
Heater positive with respect to cathode.....	200 max	volts

■ The dc component must not exceed 100 volts.

### Characteristics:

Plate Voltage .....	250	volts
Grid Voltage .....	-10.5	volts
Amplification Factor .....	16.5	
Plate Resistance (Approx.) .....	5800	ohms
Transconductance .....	3100	$\mu$ mhos
Grid Voltage (Approx.) for plate current of 50 $\mu$ a .....	-23	volts
Plate Current .....	11.5	ma

### Maximum Circuit Values (For maximum rated conditions):

Grid-Circuit Resistance:		
For fixed-bias operation .....	0.25 max	megohm
For cathode-bias operation .....	1.0 max	megohm

### OSCILLATOR

*For operation in a 525-line, 30-frame system*

Maximum Ratings (Each Unit):	Vertical Deflection Oscillator	Horizontal Deflection Oscillator	
DC PLATE VOLTAGE .....	450 max	450 max	volts
PEAK NEGATIVE-PULSE GRID VOLTAGE .....	-400 max	-600 max	volts
CATHODE CURRENT:			
Peak .....	70 max	300 max	ma
Average .....	20 max	20 max	ma
PLATE DISSIPATION .....	3.5 max	3.5 max	watts
PEAK HEATER-CATHODE VOLTAGE:			
Heater negative with respect to cathode .....	200 max	200 max	volts
Heater positive with respect to cathode .....	200° max	200° max	volts

### Maximum Circuit Value:

Grid-Circuit Resistance .....	2.2 max	2.2 max	megohms
-------------------------------	---------	---------	---------

### VERTICAL DEFLECTION AMPLIFIER

*For operation in a 525-line, 30-frame system*

#### Maximum Ratings (Each Unit):

DC PLATE VOLTAGE .....	450 max	volts
PEAK POSITIVE-PULSE PLATE VOLTAGE# (Absolute maximum) .....	1500 max	volts
PEAK NEGATIVE-PULSE GRID VOLTAGE .....	-250 max	volts
CATHODE CURRENT:		
Peak .....	70 max	ma
Average .....	20 max	ma
PLATE DISSIPATION .....	3.5 max	watts
PEAK HEATER-CATHODE VOLTAGE:		
Heater negative with respect to cathode .....	200 max	volts
Heater positive with respect to cathode .....	200° max	volts

AVERAGE PLATE CHARACTERISTICS  
EACH TRIODE UNIT

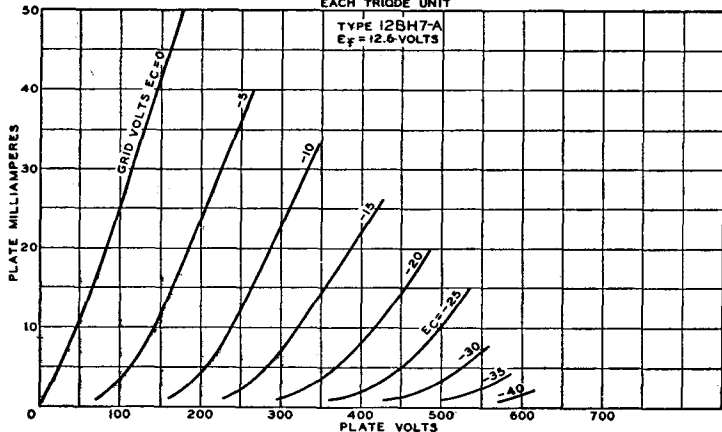

92CM-7742T1



**Maximum Circuit Value:**

**Grid-Circuit Resistance:**

For cathode-bias operation . . . . . **2.2 max** megohms

# The duration of the voltage pulse must not exceed 15 per cent of one vertical scanning cycle. In a 525-line, 30-frame system, 15 per cent of one vertical scanning cycle is 2.5 milliseconds.

■ Under no circumstances should this absolute value be exceeded.

° The dc component must not exceed 100 volts.

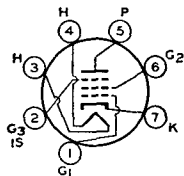

## SHARP-CUTOFF PENTODE

# 12BL6

Miniature type used as if and rf amplifier in automobile radio receivers operating from a 12-volt storage battery. Outline 11, OUTLINES SECTION. Equipment using this type

should be designed so that 90 per cent of the maximum values of plate voltage and grid-No.2 voltage is never exceeded for a battery potential of 13.2 volts. Tube requires miniature seven-contact socket and may be mounted in any position.

HEATER-VOLTAGE RANGE (AC/DC)\* . . . . . 10.0 to 15.9 volts

HEATER CURRENT (Approx.) at 12.6 volts . . . . . 0.15 ampere

**DIRECT INTERELECTRODE CAPACITANCES\*:**

Grid No.1 to Plate . . . . . 0.006 max  $\mu\mu\text{f}$

Grid No.1 to Cathode, Heater, Grid No.2, Grid No.3, and Internal Shield . . . . . 5.5  $\mu\mu\text{f}$

Plate to Cathode, Heater, Grid No.2, Grid No.3, and Internal Shield . . . . . 4.8  $\mu\mu\text{f}$

\* This voltage range is on an absolute basis. For longest life, it is recommended that the heater be operated within the voltage range of 11 to 14 volts.

\* With external shield.

## CLASS A<sub>1</sub> AMPLIFIER

**Maximum Ratings:**

PLATE VOLTAGE . . . . . 30 max volts

GRID-NO.2 (SCREEN-GRID) VOLTAGE . . . . . 30 max volts

**GRID-NO.1 (CONTROL-GRID) VOLTAGE:**

Positive bias value . . . . . 0 max volts

CATHODE CURRENT . . . . . 20 max ma

**PEAK HEATER-CATHODE VOLTAGE:**

Heater negative with respect to cathode . . . . . 30 max volts

Heater positive with respect to cathode . . . . . 30 max volts

**Typical Operation with 12.6 Volts on Heater:**

Plate Voltage . . . . . 12.6 volts

Grid No.3 (Suppressor Grid) . . . . . Connected to cathode at socket

Grid-No.2 Voltage . . . . . 12.6 volts

Grid-No.1 Voltage . . . . . -0.65 volt

Developed across grid No.1 resistor of . . . . . 2.2 megohms

Plate Resistance (Approx.) . . . . . 0.5 megohm

Transconductance . . . . . 1350  $\mu\text{mhos}$

Grid-No.1 and Grid-No.3 Voltage (Approx.) for transconductance of 10  $\mu\text{mhos}$  . . . . . -5 volts

Plate Current . . . . . 1.35 ma

Grid-No.2 Current . . . . . 0.5 ma

**Maximum Circuit Value:**

Grid-No.1-Circuit Resistance . . . . . 10 max megohms

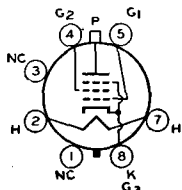

## BEAM POWER TUBE

# 12BQ6-GTB /12CU6

Glass octal type used as horizontal deflection amplifier in television receivers employing series-connected heater strings. Outline 30, OUTLINES SECTION. This type may be supplied

with pin No.1 omitted. Heater volts (ac/dc), 12.6; amperes, 0.6; warm-up time (average), 11 seconds. For definition of heater warm-up time and method for determining it, see type 6CG7. Except for heater rating, type 12BQ6-GTB/12CU6 is identical with glass octal type 6BQ6-GTB/6CU6.

**SHARP-CUTOFF PENTODE**

**12BY7**  
**12BY7-A**

Miniature types used as video amplifiers in television receivers utilizing series-connected heater strings. Outline 14, OUTLINES SECTION. Tubes require miniature nine-contact

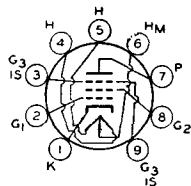

socket and may be mounted in any position. Type 12BY7 is a **DISCONTINUED** type listed for reference only.

HEATER ARRANGEMENT	Series	Parallel	
HEATER VOLTAGE (AC/DC)	12.6	6.3	volts
HEATER CURRENT	0.3	0.6	ampere
HEATER WARM-UP TIME (Average)* for 12BY7-A	—	11	seconds
<b>DIRECT INTERELECTRODE CAPACITANCES:</b>			
Grid No.1 to Plate		0.055	μf
Grid No.1 to Cathode, Heater, Grid No.2, Grid No.3, and Internal Shield		11.1	μf
Plate to Cathode, Heater, Grid No.2, Grid No.3, and Internal Shield		3.0	μf

\* For definition of heater warm-up time and method for determining it, see type 6CG7.

**CLASS A<sub>1</sub> AMPLIFIER**

**Maximum Ratings:**

PLATE SUPPLY VOLTAGE	300 max	volts
GRID NO.3 (SUPPRESSOR-GRID) VOLTAGE	0 max	volts
GRID-NO.2 (SCREEN-GRID) VOLTAGE	175 max	volts
GRID-NO.1 (CONTROL-GRID) VOLTAGE:		
Negative Bias Value	50 max	volts
Positive Bias Value	0 max	volts
GRID-NO.2 INPUT	1 max	watt
PLATE DISSIPATION	6.25 max	watts
PEAK HEATER-CATHODE VOLTAGE:		
Heater negative with respect to cathode	200 max	volts
Heater positive with respect to cathode	200* max	volts

**Characteristics:**

Plate Supply Voltage	250	volts
Grid No.3	Connected to cathode at socket	
Grid-No.2 Supply Voltage	150	volts
Cathode-Bias Resistor	68	ohms
Plate Resistance (Approx.)	90000	ohms
Transconductance	12000	μmhos
Plate Current	25	ma
Grid-No.2 Current	6	ma
Grid-No.1 Voltage for plate current of 20 μa	-10	volts

**Maximum Circuit Value:**

Grid-No.1-Circuit Resistance:		
For cathode-bias operation	1 max	megohm
For fixed-bias operation	0.25 max	megohm

° The dc component must not exceed 100 volts.

**TWIN DIODE—  
REMOTE-CUTOFF PENTODE**

**12C8**

Metal type used as combined detector, amplifier, and avc tube in ac/dc receivers. Outline 4, OUTLINES SECTION. Heater volts (ac/dc), 12.6; amperes, 0.15. Except for heater rating, this type is identical with metal type 6B8. Type 12C8 is used principally for renewal purposes.

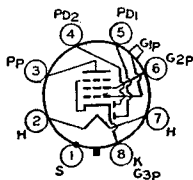

**BEAM POWER TUBE**

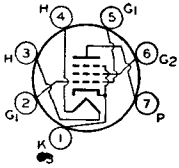

Miniature type used in the audio output stages of television receivers employing series-connected heater strings. Outline 13, OUTLINES SECTION. Tube requires miniature seven-contact socket and may be mounted in any position.

**12CA5**

HEATER VOLTAGE (AC/DC).....	12.6	volts
HEATER CURRENT.....	0.6	ampere
HEATER WARM-UP TIME (Average)*.....	11	seconds
DIRECT INTERELECTRODE CAPACITANCES (Approx.):		
Grid No.1 to Plate.....	0.5	$\mu\mu\text{f}$
Grid No.1 to Cathode, Heater, Grid No.2, and Grid No.3.....	15	$\mu\mu\text{f}$
Plate to Cathode, Heater, Grid No.2, and Grid No.3.....	9	$\mu\mu\text{f}$

\*For definition of heater warm-up time and method for determining it, see type 6CG7.

**CLASS A<sub>1</sub> AMPLIFIER**

**Maximum Ratings:**

PLATE VOLTAGE.....	130 <i>max</i>	volts
GRID-NO.2 (SCREEN-GRID) VOLTAGE.....	130 <i>max</i>	volts
GRID-NO.1 (CONTROL-GRID) VOLTAGE:		
Positive bias value.....	0 <i>max</i>	volts
PLATE DISSIPATION.....	5 <i>max</i>	watts
GRID-NO.2 INPUT.....	1.4 <i>max</i>	watts
PEAK HEATER-CATHODE VOLTAGE:		
Heater negative with respect to cathode.....	200 <i>max</i>	volts
Heater positive with respect to cathode.....	200 <i>max</i>	volts
BULB TEMPERATURE (At hottest point).....	180 <i>max</i>	$^{\circ}\text{C}$

**Typical Operation:**

Plate Voltage.....	110	125	volts
Grid-No.2 Voltage.....	110	125	volts
Grid-No.1 Voltage.....	-4.0	-4.5	volts
Peak AF Grid-No.1 Voltage.....	4.0	4.5	volts
Zero-Signal DC Plate Current.....	32	37	ma
Maximum-Signal DC Plate Current.....	31	36	ma
Zero-Signal DC Grid-No.2 Current.....	3.5	4	ma
Maximum-Signal DC Grid-No.2 Current.....	7.5	11	ma
Plate Resistance (Approx.).....	16000	15000	ohms
Transconductance.....	8100	9200	$\mu\text{mhos}$
Load Resistance.....	3500	4500	ohms

**AVERAGE PLATE CHARACTERISTICS**

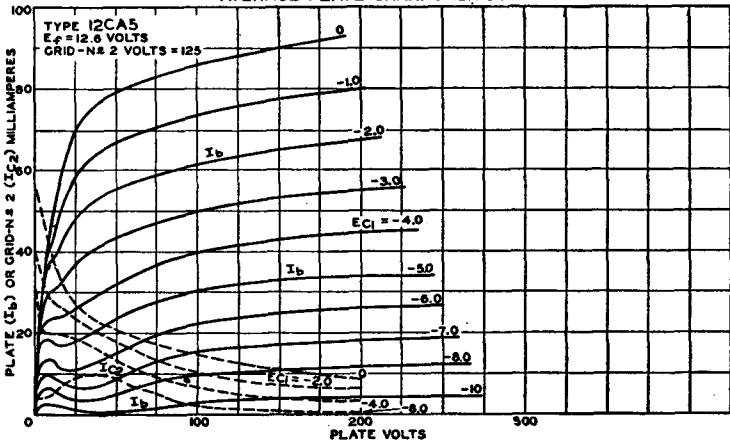

92CM-6507T

Total Harmonic Distortion.....	5	6	per cent
Maximum-Signal Power Output.....	1.1	1.5	watts

**Maximum Circuit Values:**

Grid-No.1-Circuit Resistance:			
For fixed-bias operation.....		0.1 max	megohm
For cathode-bias operation.....		0.5 max	megohm

■ The dc component must not exceed 100 volts.

## DIODE— REMOTE-CUTOFF PENTODE

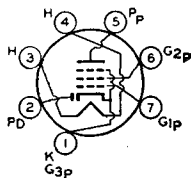

# 12CR6

Miniature type used as combined detector and audio amplifier in automobile and ac-operated radio receivers. The diode unit is used as an AM detector, and the pentode unit as an

automatic-volume-controlled audio amplifier. Outline 11, OUTLINES SECTION. Tube requires miniature seven-contact socket and may be mounted in any position.

HEATER VOLTAGE (AC/DC).....	12.6	volts
HEATER CURRENT.....	0.15	ampere

### PENTODE UNIT AS CLASS A<sub>1</sub> AMPLIFIER

**Maximum Ratings:**

PLATE VOLTAGE.....	300 max	volts
GRID-NO.2 (SCREEN-GRID) VOLTAGE.....	See curve page 67	
GRID-NO.2 SUPPLY VOLTAGE.....	300 max	volts
GRID-NO.1 (CONTROL-GRID) VOLTAGE:		
Positive bias value.....	0 max	volts
PLATE DISSIPATION.....	2.5 max	watts
GRID-NO.2 INPUT:		
For grid-No.2 voltages up to 150 volts.....	0.3 max	watt
For grid-No.2 voltages between 150 and 300 volts.....	See curve page 67	
PEAK HEATER-CATHODE VOLTAGE:		
Heater negative with respect to cathode.....	100 max	volts
Heater positive with respect to cathode.....	100 max	volts

**Characteristics:**

Plate Voltage.....	250	volts
Grid-No.2 Voltage.....	100	volts
Grid-No.1 Voltage.....	-2	volts
Plate Resistance (Approx.).....	0.8	megohm
Transconductance.....	2200	μmhos
Plate Current.....	9.6	ma
Grid-No.2 Current.....	2.6	ma
Grid-No.1 Voltage (Approx.) for transconductance of 10 μmhos.....	-32	volts

AVERAGE CHARACTERISTICS  
PENTODE UNIT

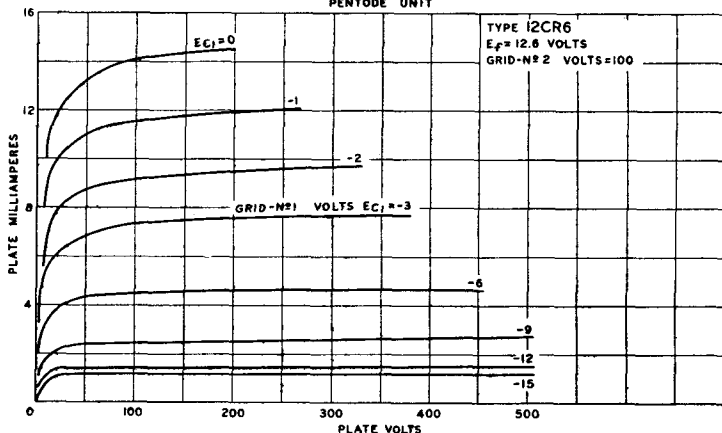

92CM-9006T

**Maximum Circuit Values:**

<b>Grid-No.1-Circuit Resistance:</b>		
For fixed-bias operation.....	0.25 max	megohm
For cathode-bias operation.....	1.0 max	megohm

**Maximum Rating:**

**DIODE UNIT**

<b>PLATE CURRENT</b> .....	1 max	ma
----------------------------	-------	----

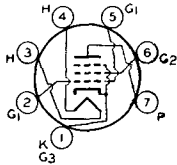

**BEAM POWER TUBE**

Miniature type used in the audio output stage of television receivers employing series-connected heater strings. Outline 13, OUTLINES SECTION. Heater volts (ac/dc), 12.6; amperes,

**12CU5**

0.6; warm-up time (average), 11 seconds. For definition of heater warm-up time and method for determining it, see type 6CG7. Except for heater rating, type 12CU5 is identical with miniature type 6CU5.

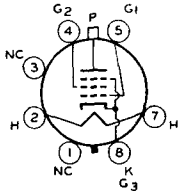

**BEAM POWER TUBE**

Glass octal type used as horizontal deflection amplifier in television receivers employing series-connected heater strings. Outline 37, OUTLINES SECTION. Heater volts (ac/dc), 12.6;

**12DQ6-A**

amperes, 0.6; warm-up time (average), 11 seconds. For definition of heater warm-up time and method for determining it, see type 6CG7. Except for heater rating, type 12DQ6-A is identical with miniature type 6DQ6-A.

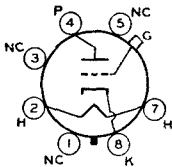

**HIGH-MU TRIODE**

Glass octal type used in resistance-coupled amplifier circuits of ac/dc receivers. Outline 21, OUTLINES SECTION. This type may be supplied with pin No.1 omitted. Heater volts (ac/dc), 12.6; amperes, 0.15. Except for heater rating, this type is identical with glass-octal type 6F5-GT. Type 12F5-GT is a DISCONTINUED type listed for reference only.

**12F5-GT**

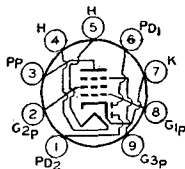

**TWIN DIODE—  
REMOTE-CUTOFF PENTODE**

Miniature type used as combined detector and af voltage amplifier in automobile radio receivers operating from a 12-volt storage battery. Outline 12, OUTLINES SECTION. Equip-

**12F8**

ment using this type should be designed so that 90 per cent of the maximum values of plate voltage and grid-No.2 voltage is never exceeded at a battery potential of 13.2 volts. Tube requires miniature nine-contact socket and may be mounted in any position.

<b>HEATER-VOLTAGE RANGE (AC/DC)*</b> .....	10.0 to 15.9	volts
<b>HEATER CURRENT (Approx.) at 12.6 volts</b> .....	0.15	ampere
<b>DIRECT INTERELECTRODE CAPACITANCES:</b>		
<b>Pentode Unit:</b>		
Grid No.1 to Plate.....	0.06	μf
Grid No.1 to Cathode, Heater, Grid No.2, and Grid No.3.....	4.5	μf
Plate to Cathode, Heater, Grid No.2, and Grid No.3.....	3.0	μf
Plate of Diode Unit No.1 to Plate of Diode Unit No.2.....	0.3	μf

\* This voltage range is on an absolute basis. For longest life, it is recommended that the heater be operated within the voltage range of 11 to 14 volts.

## PENTODE UNIT AS CLASS A<sub>1</sub> AMPLIFIER

### Maximum Ratings:

PLATE VOLTAGE.....	30 max	volts
GRID-No.2 (SCREEN-GRID) VOLTAGE.....	30 max	volts
GRID-No.1 (CONTROL-GRID) VOLTAGE Positive bias value.....	0 max	volts
PEAK HEATER-CATHODE VOLTAGE: Heater negative with respect to cathode.....	30 max	volts
Heater positive with respect to cathode.....	30 max	volts

### Typical Operation with 12.6 Volts on Heater:

Plate Voltage.....	12.6	volts
Grid-No.3 (Suppressor-Grid) Voltage.....	0	volts
Grid-No.2 Voltage.....	12.6	volts
Grid-No.1 Voltage.....	0	volts
Plate Resistance (Approx.).....	0.33	megohm
Transconductance.....	1000	μmhos

### AVERAGE TRANSFER CHARACTERISTICS

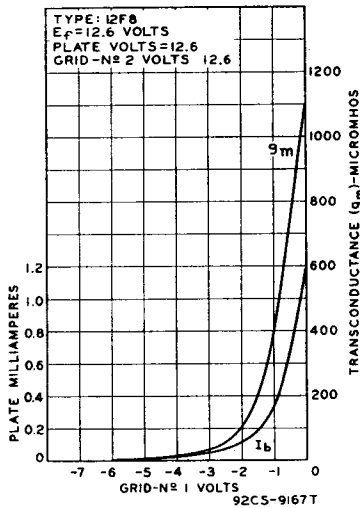

### AVERAGE CHARACTERISTICS

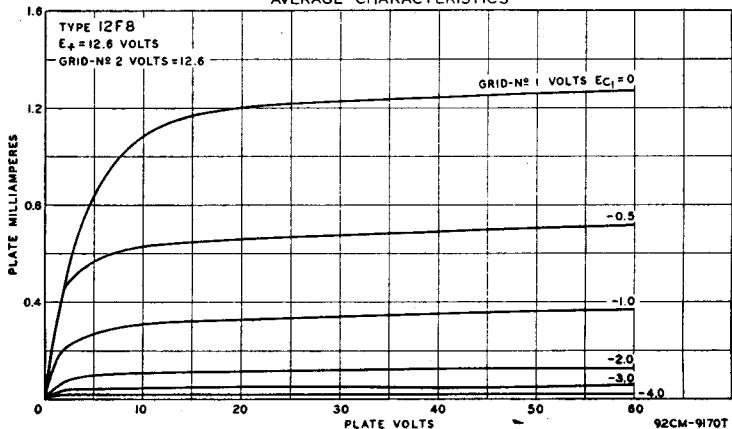

# RCA Receiving Tube Manual

Grid-No.1 Voltage (Approx.) for transconductance of 10 $\mu$ mhos.....	-5	volts
Plate Current.....	1	ma
Grid-No.2 Current.....	0.38	ma

### Maximum Circuit Value:

Grid-No.1-Circuit Resistance.....	10 max	megohms
-----------------------------------	--------	---------

## DIODE UNITS

### Maximum Rating:

PLATE CURRENT (Each Unit).....	1 max	ma
--------------------------------	-------	----

## TWIN DIODE

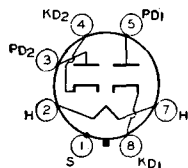

Metal type used as detector, low-voltage rectifier, or avc tube in ac/dc radio receivers. Outline 1, OUTLINES SECTION. Heater volts (ac/dc), 12.6; amperes, 0.15. Except for heater rating, this type is identical with metal type 6H6.

# 12H6

## MEDIUM-MU TRIODE

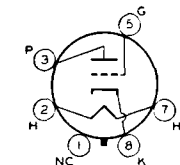

Glass octal type used as detector, amplifier, or oscillator in ac/dc radio equipment. Outline 25, OUTLINES SECTION. This type may be supplied with pin No.1 omitted. Heater volts (ac/dc), 12.6; amperes, 0.15. Except for heater rating, this type is identical with glass-octal type 6J5-GT. Type 12J5-GT is used principally for renewal purposes.

# 12J5-GT

## SHARP-CUTOFF PENTODE

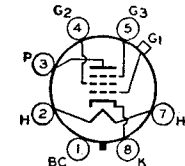

Glass octal type used as biased detector or high-gain audio amplifier in ac/dc radio receivers. Outline 24, OUTLINES SECTION. Heater volts (ac/dc), 12.6; amperes, 0.15. Except for heater rating, this type is identical with glass-octal type 6J7-GT. Type 12J7-GT is used principally for renewal purposes.

# 12J7-GT

## POWER TETRODE

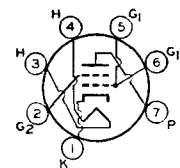

Miniature type used as power amplifier driver in automobile radio receivers operating from a 12-volt storage battery. Outline 13, OUTLINES SECTION. Equipment using this type

# 12K5

should be designed so that 90 per cent of the maximum values of plate voltage and grid-No.1 voltage is never exceeded for a battery potential of 13.2 volts. Tube requires miniature seven-contact socket and may be mounted in any position.

HEATER-VOLTAGE RANGE (AC/DC)*.....	10.0 to 15.9	volts
HEATER CURRENT (Approx.) at 12.6 volts.....	0.4	ampere

\* This voltage range is on an absolute basis. For longest life, it is recommended that the heater be operated within the voltage range of 11 to 14 volts.

## CLASS A<sub>1</sub> AMPLIFIER

### Maximum Ratings:

PLATE VOLTAGE.....	30 max	volts
GRID-NO.1 (SPACE-CHARGE-GRID) SUPPLY VOLTAGE.....	30 max	volts
GRID-NO.1 VOLTAGE (Absolute Maximum).....	16 max	volts
NEGATIVE GRID-NO.2 (CONTROL-GRID) VOLTAGE.....	-20 max	volts
<b>PEAK HEATER-CATHODE VOLTAGE:</b>		
Heater negative with respect to cathode.....	30 max	volts
Heater positive with respect to cathode.....	30 max	volts

## Typical Operation with 12.6 Volts on Heater:

Plate Voltage.....	12.6	volts
Grid-No.1 Voltage.....	12.6	volts
Grid-No.2 Voltage.....	-2	volts
Peak AF Grid-No.2 Voltage.....	2.5	volts
AF Signal-Source Resistance.....	0.1	megohm
Plate Current.....	8	ma
Grid-No.1 Current.....	85	ma
Plate Resistance.....	800	ohms
Transconductance (Grid No.2 to Plate).....	7000	$\mu$ mhos
Amplification Factor (Grid No.2 to Plate).....	5.6	
Load Resistance.....	800	ohms
Total Harmonic Distortion.....	10	per cent
Power Output.....	35	mw

## Maximum Circuit Value:

Grid-No.2-Circuit Resistance.....	2.2 max	megohms
-----------------------------------	---------	---------

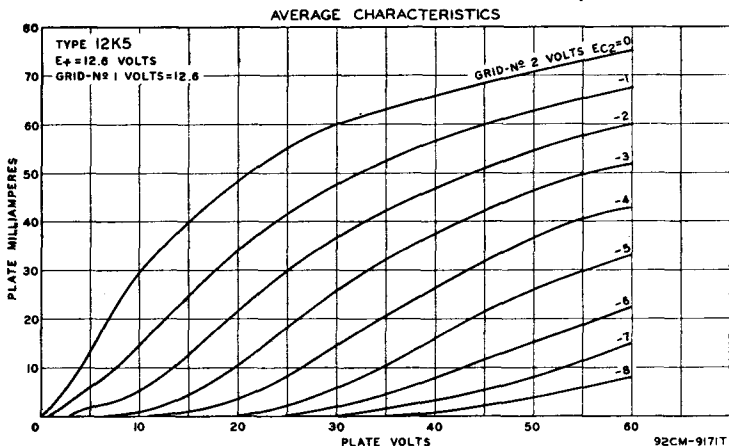

## REMOTE-CUTOFF PENTODE

Glass octal type used as rf or if amplifier in ac/dc radio receivers particularly those employing avc. Outline 24, OUTLINES SECTION. Heater volts (ac/dc), 12.6; amperes, 0.15. Except for heater rating, this type is identical with glass-octal type 6K7-GT. Type 12K7-GT is used principally for renewal purposes.

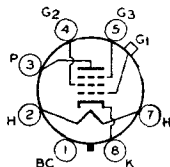

## 12K7-GT

## TRIODE-HEXODE CONVERTER

Metal type used as combined triode oscillator and hexode mixer in ac/dc radio receivers. Outline 5, OUTLINES SECTION. Heater volts (ac/dc), 12.6; amperes, 0.15. Except for heater rating, this type is identical with metal type 6K8. Type 12K8 is used principally for renewal purposes.

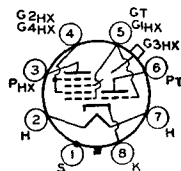

## 12K8

## BEAM POWER TUBE

Glass octal type used in audio output stages of television receivers employing series-connected heater strings. Outline 23, OUTLINES SECTION. This type may be supplied with pin

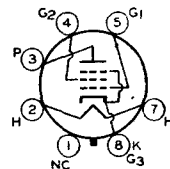

## 12L6-GT



No.1 omitted. Heater volts (ac/dc), 12.6; amperes, 0.6; warm-up time (average), 11 seconds. For definition of heater warm-up time and method for determining it, see type 6CG7. Peak heater-cathode volts: heater negative with respect to cathode, 300 *max*; heater positive with respect to cathode, 200 *max* (the dc component must not exceed 100 volts). Except for heater and heater-cathode ratings, type 12L6-GT is identical with glass octal type 50L6-GT.

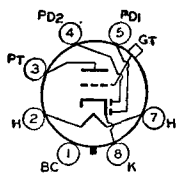

**TWIN DIODE—HIGH-MU TRIODE**

Glass octal type used as combined detector, amplifier, and ave tube in ac/dc radio receivers. Outline 24, OUTLINES SECTION. Heater volts (ac/dc), 12.6; amperes, 0.15. Except for heater rating, this type is identical with glass-octal type 6Q7-GT. Type 12Q7-GT is used principally for renewal purposes.

**12Q7-GT**

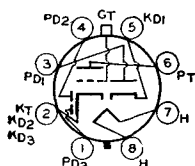

**TRIPLE DIODE—HIGH-MU TRIODE**

Glass octal type used as audio amplifier, AM detector, and FM detector in AM/FM receivers. Outline 28, OUTLINES SECTION. Heater volts (ac/dc), 12.6; amperes, 0.15. Except for heater rating, this type is identical with glass octal type 6S8-GT. Type 12S8-GT is a DISCONTINUED type listed for reference only.

**12S8-GT**

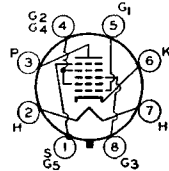

**PENTAGRID CONVERTER**

Metal type 12SA7 and glass-octal type 12SA7-GT used as converter in ac/dc receivers. Outlines 3 and 23, respectively, OUTLINES SECTION. Heater volts (ac/dc), 12.6; amperes, 0.15. Except for heater ratings, type 12SA7 is identical with metal type 6SA7, and type 12SA7-GT is identical with glass-octal type 6SA7-GT. Type 12SA7-GT is used principally for renewal purposes.

**12SA7**

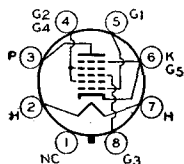

**12SA7-GT**

**HIGH-MU TWIN TRIODE**

Metal type used as phase inverter or voltage amplifier in ac/dc radio equipment. Outline 3, OUTLINES SECTION. Heater volts (ac/dc), 12.6; amperes, 0.15. Except for heater rating, this type is identical with metal type 6SC7.

**12SC7**

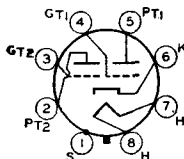

**HIGH-MU TRIODE**

Metal type 12SF5 and glass-octal type 12SF5-GT used in resistance-coupled amplifier circuits of ac/dc radio equipment. Outline 3 and 23, respectively, OUTLINES SECTION.

**12SF5  
12SF5-GT**

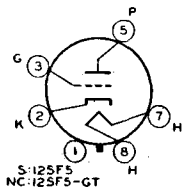

Type 12SF5-GT may be supplied with pin No.1 omitted. Heater volts (ac/dc), 12.6; amperes, 0.15. Except for heater rating, type 12SF5 is identical with metal type 6SF5, and type 12SF5-GT is identical with glass-octal type 6SF5-GT. Type 12SF5-GT is a DISCONTINUED type listed for reference only.

**DIODE—**

**REMOTE-CUTOFF PENTODE**

**12SF7**

Metal type used as combined rf or if amplifier and detector or avc tube in ac/dc radio receivers. Outline 3, OUTLINES SECTION. Heater volts (ac/dc), 12.6; amperes, 0.15. Except for heater rating, this type is identical with metal type 6SF7. Type 12SF7 is used principally for renewal purposes.

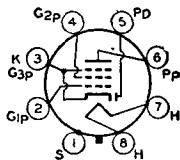

**REMOTE-CUTOFF PENTODE**

**12SG7**

Metal type used as rf amplifier in ac/dc receivers involving high-frequency, wide-band applications. Outline 3, OUTLINES SECTION. Heater volts (ac/dc), 12.6; amperes, 0.15. Except for heater rating, this type is identical with metal type 6SG7.

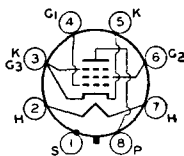

**SHARP-CUTOFF PENTODE**

**12SH7**

Metal type used as rf amplifier in ac/dc receivers involving high-frequency, wide-band applications and as limiter tube in FM equipment. Outline 3, OUTLINES SECTION. Heater volts (ac/dc), 12.6; amperes, 0.15. Except for heater rating, this type is identical with metal type 6SH7.

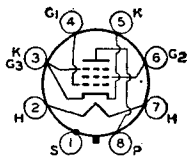

**SHARP-CUTOFF PENTODE**

**12SJ7**  
**12SJ7-GT**

Metal type 12SJ7 and glass-octal type 12SJ7-GT used as rf amplifiers and biased detectors in ac/dc radio receivers. Outlines 3 and 25, respectively, OUTLINES SECTION.

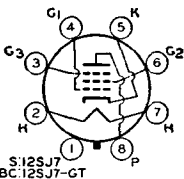

Heater volts (ac/dc), 12.6; amperes, 0.15. Except for heater rating, type 12SJ7 is identical with metal type 6SJ7, and type 12SJ7-GT is identical with glass-octal type 6SJ7-GT. Type 12SJ7-GT is a DISCONTINUED type listed for reference only.

**REMOTE-CUTOFF PENTODE**

**12SK7**  
**12SK7-GT**

Metal type 12SK7 and glass-octal type 12SK7-GT used as rf and if amplifiers in ac/dc radio receivers. Outlines 3 and 25, respectively, OUTLINES SECTION. Heater volts

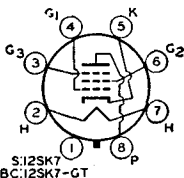

(ac/dc), 12.6; amperes, 0.15. Except for heater rating, type 12SK7 is identical with metal type 6SK7, and type 12SK7-GT is identical with glass-octal type 6SK7-GT. Type 12SK7-GT is used principally for renewal purposes.

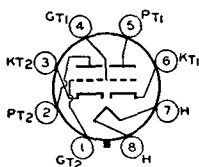

**HIGH-MU TWIN TRIODE**

Glass octal type used as phase inverter or resistance-coupled amplifier in ac/dc radio equipment. Outline 23, OUTLINES SECTION. Heater volts (ac/dc), 12.6; amperes, 0.15. Except for heater rating, this type is identical with glass-octal type 6SL7-GT.

**12SL7-GT**

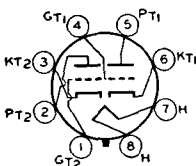

**MEDIUM-MU TWIN TRIODE**

Glass octal type used as phase inverter or resistance-coupled amplifier in ac/dc radio equipment. Outline 23, OUTLINES SECTION. Heater volts (ac/dc), 12.6; amperes, 0.3. Except for heater rating, this type is identical with glass-octal type 6SN7-GT.

**12SN7-GT**

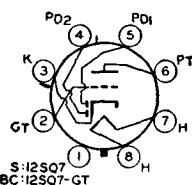

**TWIN DIODE—  
HIGH-MU TRIODE**

Metal type 12SQ7 and glass-octal type 12SQ7-GT used as combined detector, amplifier, and avc tube in ac/dc radio receivers. Outlines 3 and 25, respectively, OUTLINES SECTION.

**12SQ7  
12SQ7-GT**

Heater volts (ac/dc), 12.6; amperes, 0.15. Except for heater rating, type 12SQ7 is identical with metal type 6SQ7, and type 12SQ7-GT is identical with glass-octal type 6SQ7-GT.

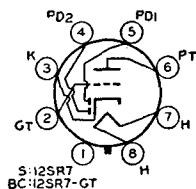

**TWIN DIODE—  
MEDIUM-MU TRIODE**

Metal type 12SR7 and glass-octal type 12SR7-GT used as combined detector, amplifier, and avc tube in ac/dc radio receivers. Outline 3 and 23, respectively, OUTLINES SECTION.

**12SR7  
12SR7-GT**

Heater volts (ac/dc), 12.6; amperes, 0.15. Except for heater rating, type 12SR7 is identical with type 6SR7, and type 12SR7-GT is electrically identical with type 6SR7 except for interelectrode capacitances. The 12SR7-GT is a DISCONTINUED type listed for reference only. Both types are similar in performance to miniature type 6BF6.

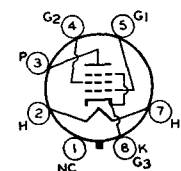

**BEAM POWER TUBE**

Glass octal type used as output amplifier primarily in automobile radio receivers operating from a 12-volt storage battery. Outline 23, OUTLINES SECTION. Tube requires octal socket

**12V6-GT**

and may be mounted in any position. Heater volts (ac/dc), 12.6; amperes, 0.225. Except for heater rating, this type is identical with glass octal type 6V6-GT.

**BEAM POWER TUBE**

**12W6-GT**

Glass octal type used in the audio output stages of television receivers employing series-connected heater strings. Triode-connected, this type is used as a vertical deflection amplifier. Outline

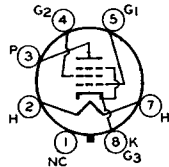

22 or 23, OUTLINES SECTION. This type may be supplied with pin No. 1 omitted. Heater volts (ac/dc), 12.6; amperes, 0.6; warm-up time (average), 11 seconds. For definition of heater warm-up time and method for determining it, see type 6CG7. Peak heater-cathode volts: heater negative with respect to cathode, 300 *max*; heater positive with respect to cathode, 200 *max* (the dc component must not exceed 100 volts). Except for heater and heater-cathode ratings, type 12W6-GT is identical with glass octal type 6W6-GT.

**FULL-WAVE VACUUM RECTIFIER**

**12X4**

Miniature type used in power supply of automobile radio receivers operating from a 12-volt storage battery. Outline 13, OUTLINES SECTION. Heater volts (ac/dc), 12.6; amperes, 0.225. Except for heater rating, this type is identical with miniature type 6X4.

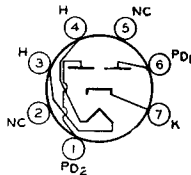

Heater volts (ac/dc), 12.6; amperes, 0.225. Except for heater rating, this type is identical with miniature type 6X4.

**HALF-WAVE VACUUM RECTIFIER**

**12Z3**

Glass types used in power supply of ac/dc receivers. Outline 34 or 35, OUTLINES SECTION. Tube requires four-contact socket and may be mounted in any position. It is especially important that this tube, like other power-handling tubes, should be adequately ventilated. Use of capacitor-input filter recommended in order to obtain as high a dc output voltage as

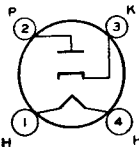

possible. Heater volts (ac/dc), 12.6; amperes, 0.3. Maximum ratings as half-wave rectifier: peak inverse plate volts, 700 *max*; peak plate ma., 330 *max*; dc output ma., 55 *max*; peak heater-cathode volts, 350 *max*. With typical operating ac plate voltages of 117, 150, and 235 volts rms, the minimum total effective plate-supply impedance required is 0, 30, and 75 ohms, respectively. This is a DISCONTINUED type listed for reference only.

**MEDIUM-MU TRIODE**

**14A4**

Glass lock-in type used as detector, amplifier, or oscillator in ac/dc radio receivers. Outline 15, OUTLINES SECTION. Tube requires lock-in socket. Heater volts (ac/dc), 12.6; amperes, 0.15. Except for heater rating and capacitances, this type is electrically identical with lock-in type 7A4 and metal type 6J5. The application of this type is similar to that of glass-octal type 12J5-GT. Type 14A4 is a DISCONTINUED type listed for reference only.

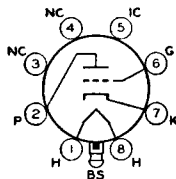

**BEAM POWER TUBE**

**14A5**

Glass lock-in type used as output amplifier in ac/dc radio receivers. Outline 15, OUTLINES SECTION. Tube requires lock-in socket. Heater volts (ac/dc), 12.6; amperes, 0.15. Typical operation and ratings as class A<sub>1</sub> amplifier: plate volts and grid-No.2 volts, 250 (300 *max*); plate dissipation, 7.5 watts; grid-No.2 input, 1.5 watts; grid-No.1 volts, -12.5; plate ma., 32;

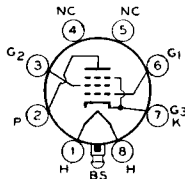

grid-No.2 ma., 5.5; plate resistance, 70000 ohms; transconductance, 3000  $\mu$ mhos; load resistance, 7500 ohms; output watts, 2.8. This is a DISCONTINUED type listed for reference only.

**REMOTE-CUTOFF PENTODE**

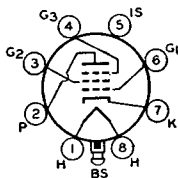

Glass lock-in type used as rf or if amplifier in ac/dc radio receivers. Outline 15, OUTLINES SECTION. Tube requires lock-in socket. Heater volts (ac/dc), 12.6; amperes, 0.15. Except for heater rating and capacitances, this type is electrically identical with metal type 6SK7 and lock-in type 7A7. The application of this type is similar to that of metal type 12SK7. Type 14A7 is used principally for renewal purposes.

**14A7**

**MEDIUM-MU TWIN TRIODE**

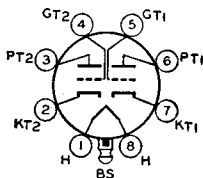

Glass lock-in type used as voltage amplifier or phase inverter in radio equipment. Outline 15, OUTLINES SECTION. Tube requires lock-in socket. Heater volts (ac/dc), 12.6; amperes, 0.15. Except for heater ratings, this type is electrically identical with lock-in type 7AF7. Type 14AF7 is used principally for renewal purposes.

**14AF7**

**TWIN DIODE—  
HIGH-MU TRIODE**

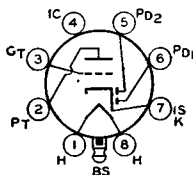

Glass lock-in type used as combined detector, amplifier, and avc tube in ac/dc radio receivers. Outline 15, OUTLINES SECTION. Tube requires lock-in socket. Heater volts (ac/dc), 12.6; amperes, 0.15. Except for heater rating and capacitances, this type is electrically identical with lock-in type 7B6 and metal type 6SQ7. The application of this type is similar to that of metal type 12SQ7. Type 14B6 is used principally for renewal purposes.

**14B6**

**PENTAGRID CONVERTER**

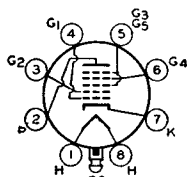

Glass lock-in type used as converter in ac/dc radio receivers. Outline 15, OUTLINES SECTION. Tube requires lock-in socket. Heater volts (ac/dc), 12.6; amperes, 0.15. Except for heater rating and capacitances, this type is electrically identical with lock-in type 7B8 and metal type 6A8. The application of this type is similar to that of glass-octal type 12A8-GT. Type 14B8 is a DISCONTINUED type listed for reference only.

**14B8**

**BEAM POWER TUBE**

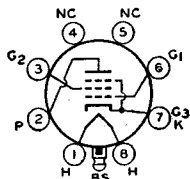

Glass lock-in type used as output amplifier in ac/dc radio receivers. Outline 20, OUTLINES SECTION. Tube requires lock-in socket. Heater volts (ac/dc), 12.6; amperes, 0.225. Except for heater rating, this type is electrically identical with lock-in type 7C5 and metal type 6V6. Type 14C5 is a DISCONTINUED type listed for reference only.

**14C5**

**SHARP-CUTOFF PENTODE**

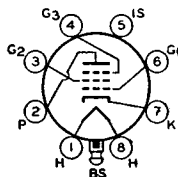

Glass lock-in type used as rf amplifier and biased detector in ac/dc radio receivers. Outline 15, OUTLINES SECTION. Tube requires lock-in socket. Heater volts (ac/dc), 12.6; amperes, 0.15. Typical operation and maximum ratings as class A<sub>1</sub> amplifier: plate volts, 250 (300 max); grid-No.2 volts, 100; plate dissipation, 1 maz watt; grid-No.2 input, 0.1

**14C7**

maz watt; grid No.1 volts, -3; grid No.3 connected to cathode at socket; plate resistance, greater than 1 megohm; transconductance, 1575  $\mu$ mhos; plate ma., 2.2; grid-No.2 ma., 0.7. Within the limits of its maximum ratings, this type is similar in performance to metal types 6SJ7 and 12SJ7. Type 14C7 is used principally for renewal purposes.

**TWIN DIODE—MEDIUM-MU TRIODE**

Glass lock-in type used as combined detector, amplifier, and avc tube in ac/dc radio receivers. Outline 15, OUTLINES SECTION. Tube requires lock-in socket. Heater volts, (ac/dc), 12.6; amperes, 0.15. Except for heater rating, this type is electrically identical with lock-in type 7E6 and miniature type 6BF6. The application of this type is similar to that of metal type 12SR7. Type 14E6 is a DISCONTINUED type listed for reference only.

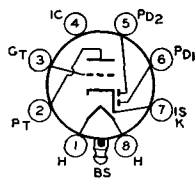

**14E6**

**TWIN DIODE—REMOTE-CUTOFF PENTODE**

Glass lock-in type used as combined detector, amplifier, and avc tube in ac/dc receivers. Outline 15, OUTLINES SECTION. Tube requires lock-in socket. Heater volts (ac/dc), 12.6; amperes, 0.15. Except for heater rating, this type is electrically identical with lock-in type 7E7. Type 14E7 is a DISCONTINUED type listed for reference only.

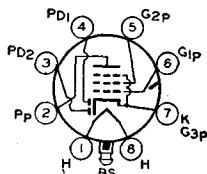

**14E7**

**HIGH-MU TWIN TRIODE**

Glass lock-in type used as phase inverter or resistance-coupled amplifier in ac/dc radio receivers. Outline 15, OUTLINES SECTION. Tube requires lock-in socket. Heater volts (ac/dc), 12.6; amperes, 0.15. Except for heater rating, this type is electrically identical with lock-in type 7F7 and glass-octal type 6SL7-GT. The application of this type is similar to that of glass-octal type 12SL7-GT. Type 14F7 is used principally for renewal purposes.

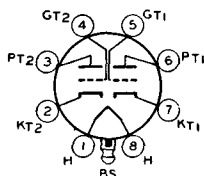

**14F7**

**MEDIUM-MU TWIN TRIODE**

Glass lock-in type used as amplifier or oscillator in ac/dc radio equipment. Outline 15, OUTLINES SECTION, except over-all length is 2-9/32 max inches and seated length is 1-3/4 inches. Tube requires lock-in socket. Heater volts (ac/dc), 12.6; amperes, 0.15. Except for heater rating, this type is electrically identical with lock-in type 7F8. Type 14F8 is used principally for renewal purposes.

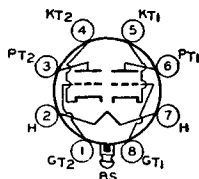

**14F8**

**REMOTE-CUTOFF PENTODE**

Glass lock-in type used as rf or if amplifier in ac/dc radio receivers. Outline 15, OUTLINES SECTION. Tube requires lock-in socket. Heater volts (ac/dc), 12.6; amperes, 0.15. Except for heater rating, this type is electrically identical with lock-in type 7H7. The application of this type is similar to that of miniature type 12BA6. Type 14H7 is a DISCONTINUED type listed for reference only.

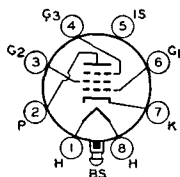

**14H7**

**TRIODE—HEPTODE CONVERTER**

Glass lock-in type used as combined triode oscillator and heptode mixer in ac/dc radio receivers. Outline 15, OUTLINES SECTION. Tube requires lock-in socket. Heater volts (ac/dc), 12.6; amperes, 0.15. Except for heater rating, this type is electrically identical with lock-in type 7J7. Type 14J7 is a DISCONTINUED type listed for reference only.

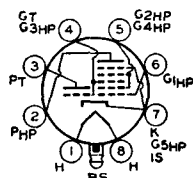

**14J7**

**MEDIUM-MU TWIN TRIODE**

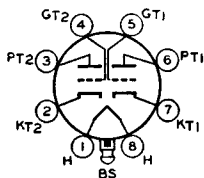

**14N7**

to that of glass-octal type 12SN7-GT. Type 14N7 is a DISCONTINUED type listed for reference only.

**PENTAGRID CONVERTER**

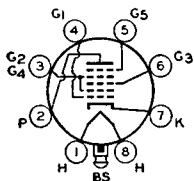

**14Q7**

Glass lock-in type used as converter in ac/dc radio receivers. Outline 15, OUTLINES SECTION. Tube requires lock-in socket. Heater volts (ac/dc), 12.6; amperes, 0.15. Except for heater ratings and capacitances, this type is electrically identical with metal type 6SA7 and lock-in type 7Q7. The application of this type is similar to that of metal type 12SA7. Type 14Q7 is used principally for renewal purposes.

**TWIN DIODE—  
REMOTE-CUTOFF PENTODE**

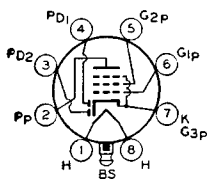

**14R7**

Glass lock-in type used as combined detector, amplifier, and avc tube in ac/dc radio receivers. Outline 15, OUTLINES SECTION. Tube requires lock-in socket. Heater volts (ac/dc), 12.6; amperes, 0.15. Except for heater rating, this type is electrically identical with lock-in type 7R7. Type 14R7 is used principally for renewal purposes.

**SHARP-CUTOFF PENTODE**

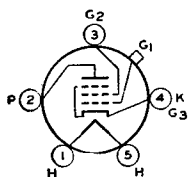

**15**

Glass type used as rf amplifier in battery-operated receivers. Outline 39, OUTLINES SECTION. Tube requires five-contact socket. Heater volts (dc), 2.0; amperes, 0.22. Typical operation as class A<sub>1</sub> amplifier: plate volts, 135 max; grid-No.2 (screen-grid) volts, 67.5 max; grid-No.1 volts, -1.5; plate ma., 1.85; grid-No.2 ma., 0.3; plate resistance, 0.80 megohm; transconductance, 750 μmhos. This is a DISCONTINUED type listed for reference only.

**HALF-WAVE VACUUM RECTIFIER**

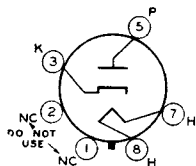

**17AX4-GT**

(ac/dc), 16.8; amperes, 0.45; warm-up time (average), 11 seconds. For definition of heater warm-up time and method for determining it, see type 6CG7. Except for heater rating, type 17AX4-GT is identical with glass octal type 6AX4-GT.

**BEAM POWER TUBE**

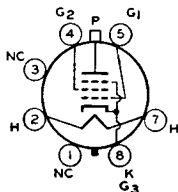

**17BQ6-  
GTB**

amperes, 0.45; warm-up time (average), 11 seconds. For definition of heater warm-up time and method for determining it, see type 6CG7. Except for heater rating, type 17BQ6-GTB is identical with glass octal type 6BQ6-GTB/6CU6.

**BEAM POWER TUBE**

**17DQ6-A**

Glass octal type used as horizontal deflection amplifier in television receivers employing series-connected heater strings. Outline 37, OUTLINES SECTION. Heater volts (ac/dc), 16.8;

amperes, 0.45; warm-up time (average), 11 seconds. For definition of heater warm-up time and method for determining it, see type 6CG7. Except for heater rating, type 17DQ6-A is identical with glass octal type 6DQ6-A.

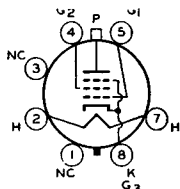

**HIGH-MU TWIN POWER TRIODE**

**19**

Glass type used in output stage of battery-operated receivers. Outline 34 or 35, OUTLINES SECTION. Tube requires six-contact socket. Filament volts (dc), 2.0; amperes, 0.26. Except for filament current, this type is electrically identical with type 1J6-GT. Type 19 is a DISCONTINUED type listed for reference only.

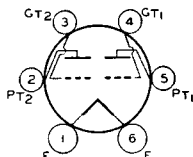

**HALF-WAVE VACUUM RECTIFIER**

**19AU4**

Glass octal type used as damper diode in horizontal-deflection circuits of black-and-white television receivers employing series-connected heater strings. Outline 29, OUTLINES SECTION.

Tube requires octal socket and may be mounted in any position. It is especially important that this tube, like other power-handling tubes, be adequately ventilated. For curve of average plate characteristics, see page 64.

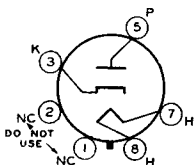

HEATER VOLTAGE (AC/DC) .....	18.9	volts
HEATER CURRENT .....	0.6	ampere
HEATER WARM-UP TIME (Average)* .....	11	seconds
DIRECT INTERELECTRODE CAPACITANCES (Approx.):		
Plate to Heater and Cathode .....	8.5	μf
Cathode to Heater and Plate .....	11.5	μf
Heater to Cathode .....	4.0	μf

\* For definition of heater warm-up time and method for determining it, see type 6CG7.

**DAMPER SERVICE**

*For operation in a 525-line, 30-frame system*

**Maximum Ratings:**

PEAK INVERSE PLATE VOLTAGE <sup>‡</sup> (Absolute maximum) .....	4500 <sup>o</sup> max	volts
PEAK PLATE CURRENT .....	1050 max	ma
DC PLATE CURRENT .....	175 max	ma
PLATE DISSIPATION .....	6 max	watts
PEAK HEATER-CATHODE VOLTAGE:		
Heater negative with respect to cathode .....	4500 <sup>o</sup> max	volts
Heater positive with respect to cathode .....	300 <sup>†</sup> max	volts

<sup>o</sup> The duration of the voltage pulse must not exceed 15 per cent of one horizontal scanning cycle. In a 525-line, 30-frame system, 15 per cent of one horizontal scanning cycle is 10 microseconds.

<sup>†</sup> Under no circumstances should this absolute value be exceeded.

<sup>‡</sup> The dc component must not exceed 900 volts.

<sup>‡</sup> The dc component must not exceed 100 volts.

**BEAM POWER TUBE**

**19BG6-G**

**19BG6-GA**

Glass octal types used as output amplifiers in horizontal deflection circuits of television equipment of the "transformerless" type where high pulse voltages occur during short duty cycles. Outlines 45 and 53, respectively, OUTLINES SECTION. Tubes require octal socket. Vertical tube mounting is preferred but horizontal operation is permissible if pins No.2 and No.7 are in vertical plane. Heater volts (ac/dc),

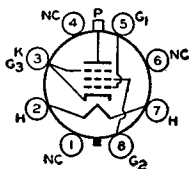



18.9; amperes, 0.3. Direct interelectrode capacitances (approx.) for type 19BG6-GA: grid No.1 to plate, 0.8  $\mu\text{mf}$ ; grid No.1 to cathode, heater, grid No.2, and grid No.3, 11  $\mu\text{mf}$ ; plate to cathode, heater, grid No.2, and grid No.3, 6  $\mu\text{mf}$ . Except for heater rating and interelectrode capacitances, type 19BG6-GA is electrically identical with glass octal type 6BG6-G. Type 19BG6-G is a DISCONTINUED type listed for reference only. Type 19BG6-GA is used principally for renewal purposes.

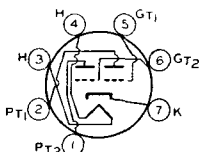

### MEDIUM-MU TWIN TRIODE

Miniature type used for converter service in ac/dc AM and FM receivers and as oscillator, amplifier, or mixer in television receivers of the "transformerless" type. Outline 11, OUTLINES SECTION. Tube requires miniature seven-contact socket and may be mounted in any position. Heater volts (ac/dc), 18.9; amperes, 0.15. For direct interelectrode capacitances, ratings, and typical operation as a class A<sub>1</sub> amplifier, and curves, refer to type 6J6. Maximum ratings and characteristics for mixer service (each unit): plate volts, 150 (300 *max*); cathode-bias resistor, 810 ohms; peak oscillator volts, 3; plate resistance, 10200 ohms; conversion transconductance, 1900  $\mu\text{mhos}$ ; plate ma., 4.8; plate dissipation, 1.5 *max* watts; peak heater-cathode volts, 90 *max*. Type 19J6 is used principally for renewal purposes.

**19J6**

ances, ratings, and typical operation as a class A<sub>1</sub> amplifier, and curves, refer to type 6J6. Maximum ratings and characteristics for mixer service (each unit): plate volts, 150 (300 *max*); cathode-bias resistor, 810 ohms; peak oscillator volts, 3; plate resistance, 10200 ohms; conversion transconductance, 1900  $\mu\text{mhos}$ ; plate ma., 4.8; plate dissipation, 1.5 *max* watts; peak heater-cathode volts, 90 *max*. Type 19J6 is used principally for renewal purposes.

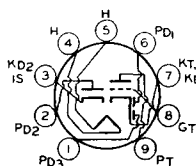

### TRIPLE DIODE-HIGH-MU TRIODE

Miniature type used as combined audio amplifier, AM detector, and FM detector in AM/FM receivers of the a/c or "transformer" type. Outline 15, OUTLINES SECTION. Tube requires miniature nine-contact socket and may be mounted in any position. Heater volts (ac/dc), 18.9; amperes, 0.15. Except for

**19T8**

heater rating, this type is identical with miniature type 6T8. Type 19T8 is used principally for renewal purposes.

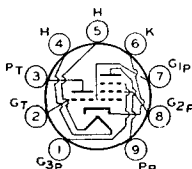

### TRIODE-PENTODE CONVERTER

Miniature type used as combined oscillator and mixer tube in "transformerless" AM/FM receivers. Outline 12, OUTLINES SECTION. Tube requires miniature nine-contact socket

**19X8**

and may be mounted in any position. Heater volts (ac/dc), 18.9; amperes, 0.15. Except for heater rating, this type is identical with miniature type 6X8.

### POWER TRIODE

Glass type used as output amplifier in dry-battery-operated receivers. Filament volts (dc), 3.3; amperes, 0.132. Characteristics as class A<sub>1</sub> amplifier: plate volts, 135 *max*; grid volts, -22.5; plate ma., 6.5; plate resistance, 6300 ohms; amplification factor, 3.3; transconductance, 525  $\mu\text{mhos}$ ; load resistance, 6500 ohms; output mw., 110. This is a DISCONTINUED type listed for reference only.

**20**

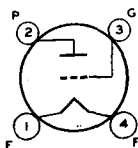

### SHARP-CUTOFF TETRODE

Glass type used as rf amplifier in dry-battery-operated receivers. Outline 45, OUTLINES SECTION. Filament volts (dc), 3.3; amperes, 0.132. Characteristics as class A<sub>1</sub> amplifier: plate volts, 135 *max*; grid-No.2 (screen-grid) volts, 67.5 *max*; grid-No.1 volts, -1.5; plate ma., 3.7; grid-No.2 ma., 1.3; plate resistance, 325000 ohms; transconductance, 500  $\mu\text{mhos}$ . This is a DISCONTINUED type listed for reference only.

**22**

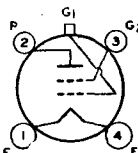

# 24-A

## SHARP-CUTOFF TETRODE

Glass type used as rf amplifier or biased detector in ac-operated receivers. Outline 45, OUTLINES SECTION. Tube requires five-contact socket. Heater volts (ac/dc), 2.5; amperes, 1.75. Typical operation and maximum ratings as class A<sub>1</sub> amplifier: plate volts, 250 (275 max); grid-No.2 volts, 90; grid-No.1 volts, -3; plate resistance, 0.6 megohm; trans-

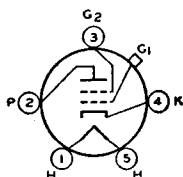

conductance, 1050  $\mu$ hos; plate ma., 4; grid-No.2 ma., 1.7 max. This type is used principally for renewal purposes.

## POWER PENTODE

Metal type 25A6 and glass-octal type 25A6-GT are used in output stage of ac/dc receivers. Outlines 6 and 23, respectively, OUTLINES SECTION. Type 25A6-GT may be supplied with pin No.1 omitted. Tubes require octal socket and may be mounted in any position. Heater volts (ac/dc), 25; amperes, 0.3. Maximum ratings as class A<sub>1</sub> amplifier: plate

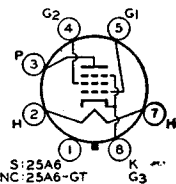

volts, 160; grid-No.2 volts, 135; plate dissipation, 5.3 watts; grid-No.2 input, 1.9 watts. These are DISCONTINUED types listed for reference only.

# 25A6 25A6-GT

## RECTIFIER—POWER PENTODE

Glass octal type used as combined half-wave rectifier and power amplifier. Outline 23, OUTLINES SECTION. Heater volts (ac/dc), 25; amperes, 0.3. Typical operation of pentode unit as class A<sub>1</sub> amplifier: plate volts and grid-No.2 volts, 100 (117 max); grid-No.1 volts, -15; plate ma., 20.5; grid-No.2 ma., 4; plate resistance, 50000 ohms, transconductance, 1800

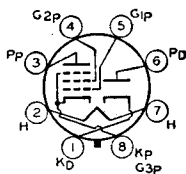

$\mu$ hos; load resistance, 4500 ohms; output watts, 0.77. Maximum ratings of rectifier unit: peak inverse plate volts, 350; peak plate ma., 450; dc output ma., 75; peak heater-cathode volts, 175. This is a DISCONTINUED type listed for reference only.

# 25A7-GT

## HIGH-MU POWER TRIODE

Glass octal type used in output stage of ac/dc receivers. Outline 23, OUTLINES SECTION. This type may be supplied with pin No.1 omitted. Heater volts (ac/dc), 25; amperes, 0.3. Maximum ratings: plate volts, 180 max; plate dissipation, 10 max watts. This is a DISCONTINUED type listed for reference only.

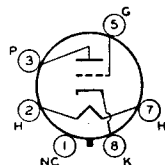

# 25AC5-GT

## DIRECT-COUPLED POWER AMPLIFIER

Glass type used as class A<sub>1</sub> power amplifier. One triode, the driver, is directly connected within the tube to the second, or output, triode. Heater volts (ac/dc), 25; amperes, 0.3. Maximum ratings and characteristics are the same as for type 25N6-G Type 25B5 is a DISCONTINUED type listed for reference only

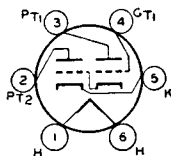

# 25B5

## POWER PENTODE

Glass octal type used in output stage of ac/dc receivers. Outline 41, OUTLINES SECTION. Heater volts (ac/dc), 25; amperes, 0.3. Typical operation as class A<sub>1</sub> amplifier: plate volts, 200 max; grid-No.2 volts, 135 max; grid-No.1 volts, -23; plate ma., 62; grid-No.2 ma., 1.8; plate resistance, 18000 ohms; transconductance, 5000  $\mu$ hos; load resistance, 2500 ohms; output watts, 7.1. This is a DISCONTINUED type listed for reference only.

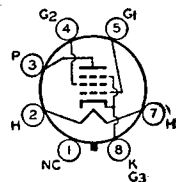

# 25B6-G

**TRIODE—PENTODE**

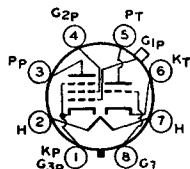

ductance, 2000  $\mu$ mhos, grid-No.1 volts for transconductance of 2  $\mu$ mhos, -41. Triode unit: plate volts, 100; grid volts, -1; plate ma., 0.6; amplification factor, 112; plate resistance, 75000; transconductance, 1500  $\mu$ mhos. This is a DISCONTINUED type listed for reference only.

**25B8-GT**

**BEAM POWER TUBE**

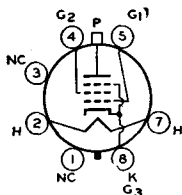

(ac/dc), 25; amperes, 0.3. Except for heater rating, type 25BQ6-GT is identical with glass octal type 6BQ6-GT, and type 25BQ6-GTB/25CU6 is identical with glass octal type 6BQ6-GTB/6CU6. Type 25BQ6-GT is used principally for renewal purposes.

**25BQ6-GT**  
**25BQ6-GTB**  
**/25CU6**

**BEAM POWER TUBE**

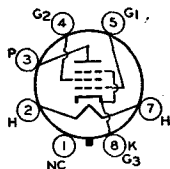

Glass octal type used as output amplifier. Outline 41, OUTLINES SECTION. Heater volts (ac/dc), 25; amperes, 0.3. Refer to type 6Y6-G for typical operation as a class A<sub>1</sub> amplifier. Type 25C6-G is a DISCONTINUED type listed for reference only.

**25C6-G**

**BEAM POWER TUBE**

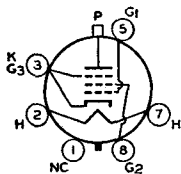

amperes, 0.6; warm-up time (average), 11 seconds. For definition of heater warm-up time and method for determining it, see type 6CG7. Peak heater-cathode volts, 200 max. When the heater is positive with respect to the cathode, the dc component of the heater-cathode voltage must not exceed 100 volts. Except for heater and heater-cathode ratings, type 25CD6-GA is identical with glass octal type 6CD6-G and type 25CD6-GB is identical with glass octal type 6CD6-GA.

**25CD6-GA**  
**25CD6-GB**

**BEAM POWER TUBE**

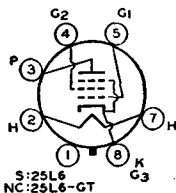

may be mounted in any position. Type 25L6-GT may be supplied with pin No.1 omitted. Heater volts (ac/dc), 25; amperes, 0.3. For maximum ratings and typical

**25L6**  
**25L6-GT**

operation, refer to type 50L6-GT. Refer to miniature type 50C5 for curves, installation, and application information, but take into consideration the differences in heater ratings.

**DIRECT-COUPLED TWIN  
POWER AMPLIFIER**

**25N6-G**

Glass octal type used as class A<sub>1</sub> power amplifier. One triode, the driver, is directly connected within the tube to the second, or output, triode. Heater volts (ac/dc), 25; amperes, 0.3. Characteristics as class A<sub>1</sub> amplifier—input triode: plate volts, 100 (180 *max*); grid volts, 0; peak af grid volts, 29.7; plate ma., 5.8. Output triode: plate volts, 180 *max*; plate ma., 46; load

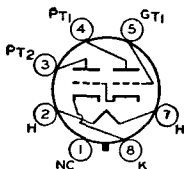

resistance, 4000 ohms; output watts, 3.8. This is a **DISCONTINUED** type listed for reference only.

**HALF-WAVE VACUUM RECTIFIER**

**25W4-GT**

Glass octal type used as damper diode in magnetic deflection circuit of television receivers and as a rectifier in conventional power-supply applications. Outline 22, **OUTLINES SECTION**. This type may be supplied with pin No.1 omitted. Heater volts (ac/dc), 25; amperes, 0.3. Except for heater rating and, in damper service, a peak inverse plate voltage rating of 2000 *max*

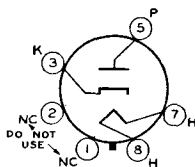

volts and a peak heater-cathode voltage rating of 450 *max* volts with heater negative with respect to cathode, this type is identical with glass octal type 6W4-GT. Type 25W4-GT is used principally for renewal purposes.

**VACUUM RECTIFIER-DOUBLER**

**25Y5**

Glass type used as half-wave rectifier or voltage doubler in ac/dc receivers. Outline 34 or 35, **OUTLINES SECTION**. Heater volts (ac/dc), 25; amperes, 0.3. Maximum ratings: peak inverse plate volts, 700; peak plate ma. per plate, 450; peak heater-cathode volts, 350; dc output ma. per plate, 75. This is a **DISCONTINUED** type listed for reference only.

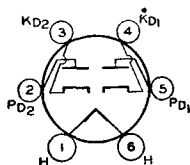

**VACUUM RECTIFIER-DOUBLER**

**25Z5**

Glass type used as half-wave rectifier or voltage doubler in ac/dc receivers. For voltage-doubler considerations, refer to **ELECTRON TUBE APPLICATIONS SECTION**. Outline 34 or 35, **OUTLINES SECTION**. Tube requires six-contact socket and may be mounted in any position. Heater volts (ac/dc), 25; amperes, 0.3. This type is electrically identical with metal type 25Z6. Type 25Z5 is used principally for renewal purposes.

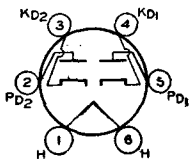

**VACUUM RECTIFIER-DOUBLER**

**25Z6  
25Z6-GT**

Metal type 25Z6 and glass-octal type 25Z6-GT used as half-wave rectifiers or voltage-doublers in ac/dc receivers. These types are used particularly in "transformerless" receivers of

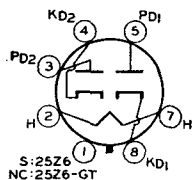

either the ac/dc type or the voltage-doubler type. Outlines 6 and 23, respectively, **OUTLINES SECTION**. Type 25Z6-GT may be supplied with pin No.1 omitted. Tubes require octal socket and may be mounted in any position. Type 25Z6 is a **DISCONTINUED** type listed for reference only.

HEATER VOLTAGE (AC/DC) .....	25	volts
HEATER CURRENT .....	0.3	ampere

**Maximum Ratings:**
**HALF-WAVE RECTIFIER**

PEAK INVERSE PLATE VOLTAGE .....	700 max	volts
PEAK PLATE CURRENT (Per Plate).....	450 max	ma
DC OUTPUT CURRENT (Per Plate).....	75 max	ma
PEAK HEATER-CATHODE VOLTAGE.....	350 max	volts

**Typical Operation (Capacitor-Input Filter):\***
*(Unless otherwise indicated, values are for both plates in parallel.)*

AC Plate-Supply Voltage per Plate (rms) .....	117	160	235	volts
Filter-Input Capacitor.....	16	16	16	$\mu$ f
Min. Total Effective Plate-Supply Impedance per Plate†.....	15	40	100	ohms
DC Output Current per Plate.....	75	75	75	ma
DC Output Voltage At Input to Filter (Approx.):				
At half-load current (75 ma.).....	115	-	255	volts
At full-load current (150 ma.).....	80	-	200	volts
Voltage Regulation (Approx.):				
Half-load to full-load current.....	35	-	55	volts

**Maximum Ratings:**
**VOLTAGE DOUBLER**
**(Same as for Half-Wave Rectifier.)**
**Typical Operation:**

	<i>Half-Wave</i>	<i>Full-Wave</i>	
AC Plate-Supply Voltage per Plate (rms) .....	117	117	volts
Filter-Input Capacitor (Each).....	16	16	$\mu$ f
Min. Total Effective Plate-Supply Impedance per Plate†.....	30	15	ohms
DC Output Current.....	75	75	ma

\* In half-wave rectifier service, the two units may be used separately or in parallel.

† When a filter-input capacitor larger than 40  $\mu$ f is used, it may be necessary to use more plate-supply impedance than the minimum value shown to limit the peak plate current to the rated value.

## MEDIUM-MU TRIODE

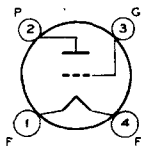

Glass type used as rf voltage amplifier in ac-operated receivers. Outline 42, OUTLINES SECTION. Tube requires four-contact socket. Filament volts (ac/dc), 1.5; amperes, 1.05. Typical operation as class A<sub>1</sub> amplifier: plate volts, 180 max; grid volts, -14.5, plate ma., 6.2; plate resistance, 7300 ohms; transconductance, 1150  $\mu$ mhos; amplification factor, 8.3. This is a DISCONTINUED type listed for reference only.

**26**

## MEDIUM-MU TRIODE

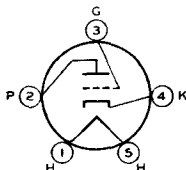

Glass type used as voltage amplifier or detector in ac-operated receivers. Outline 34 or 35, OUTLINES SECTION. Tube requires five-contact socket. Heater volts (ac/dc), 2.5; amperes, 1.75. Maximum ratings and characteristics as class A<sub>1</sub> amplifier: plate volts, 250 max; grid volts, -21; amplification factor, 9; plate resistance, 9250 ohms; transconductance, 975  $\mu$ mhos; plate ma., 5.2. This type is used principally for renewal purposes.

**27**

## MEDIUM-MU TRIODE

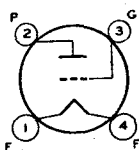

Glass type used as voltage amplifier or detector in battery-operated receivers. Outline 34 or 35, OUTLINES SECTION. Tube requires four-contact socket. Filament volts (dc), 2.0; amperes, 0.06. Except for interelectrode capacitances, this type is electrically identical with glass-octal type 1H4-G. Type 30 is a DISCONTINUED type listed for reference only.

**30**

## POWER TRIODE

**31**

Glass type used in output stage of battery-operated receivers. Outline 34 or 35, **OUTLINES SECTION**. Tube requires four-contact socket. Filament volts (dc), 2.0; amperes, 0.13. Typical operation as class A<sub>1</sub> amplifier: plate volts, 180 *max*; grid volts, -30; plate ma., 12.3; plate resistance, 3600 ohms; amplification factor, 3.8; transconductance, 1050  $\mu$ mhos; load resistance, 5700 ohms; output watts, 0.375. This is a **DISCONTINUED** type listed for reference only.

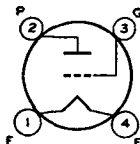

## SHARP-CUTOFF TETRODE

**32**

Glass type used as rf amplifier or biased detector in battery-operated receivers. Outline 46, **OUTLINES SECTION**. Tube requires four-contact socket. Filament volts (dc), 2.0; amperes, 0.06. Typical operation as class A<sub>1</sub> amplifier: plate volts, 180 *max*; grid-No.2 ma., 0.4 *max*; plate resistance, greater than 1 megohm; plate ma., 1.7; transconductance, 650  $\mu$ mhos. This is a **DISCONTINUED** type listed for reference only.

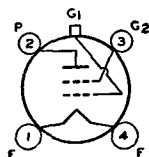

## RECTIFIER—BEAM POWER TUBE

**32L7-GT**

Glass octal type used as combined half-wave rectifier and output amplifier in ac/dc receivers. Outline 23, **OUTLINES SECTION**. Tube requires octal socket. Heater volts (ac/dc), 32.5; amperes, 0.3. Maximum ratings for rectifier unit: ac plate volts (rms), 125; dc output ma., 60. Typical operation of beam power unit as class A<sub>1</sub> amplifier: plate and grid-No.2 volts,

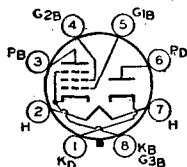

90; grid-No.1 volts, -7; plate ma., 27; grid-No.2 ma., 2; plate resistance, 17000 ohms; transconductance, 4800  $\mu$ mhos; load resistance, 2600 ohms; maximum-signal output watts, 1.0. This is a **DISCONTINUED** type listed for reference only.

## POWER PENTODE

**33**

Glass type used in output stage of battery-operated receivers. Outline 42, **OUTLINES SECTION**. Tube requires five-contact socket. Filament volts (dc), 2.0; amperes, 0.26. Typical operation as class A<sub>1</sub> amplifier: plate and grid-No.2 volts, 180 *max*; grid-No.1 volts, -18; plate ma., 22; grid-No.2 ma., 5; plate resistance, 55000 ohms; transconductance, 1750  $\mu$ mhos;

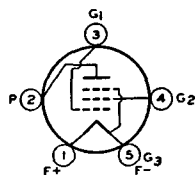

load resistance, 6000 ohms; output watts, 1.4. This is a **DISCONTINUED** type listed for reference only.

## REMOTE-CUTOFF PENTODE

**34**

Glass type used as rf or if amplifier in battery-operated radio receivers, particularly those employing avc. Outline 46, **OUTLINES SECTION**. Tube requires four-contact socket. Filament volts (dc), 2.0; amperes, 0.06. Characteristics as class A<sub>1</sub> amplifier: plate volts, 180 *max*; grid-No.2 volts, 67.5 *max*; grid-No.1 volts, -3 *min*; plate ma., 2.8; grid-No.2 ma., 1.0; plate

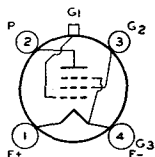

resistance, 1.0 megohm; transconductance, 620  $\mu$ mhos; transconductance at grid-No.1 voltage of -22.5 volts, 15  $\mu$ mhos. This is a **DISCONTINUED** type listed for reference only.

## REMOTE-CUTOFF TETRODE

**35**

Glass type used as rf or if amplifier in ac receivers. Outline 46, **OUTLINES SECTION**. Tube requires five-contact socket. Heater volts (ac/dc), 2.5; amperes, 1.75. Characteristics as class A<sub>1</sub> amplifier: plate volts, 250 (275 *max*); grid-No.2 volts, 90 *max*; grid-No.1 volts, -3 *min*; plate ma., 6.5; grid-No.2 ma., 2.5; transconductance, 1050  $\mu$ mhos; transconductance at

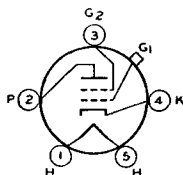

grid-No.1 voltage of -40 volts, 15  $\mu$ mhos. This is a **DISCONTINUED** type listed for reference only.

**BEAM POWER TUBE**

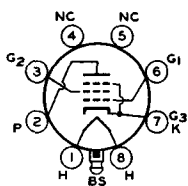

Glass lock-in type used in output stage of ac/dc receivers. Outline 20, OUTLINES SECTION. Tube requires lock-in socket. Heater volts (ac/dc), 35; amperes, 0.15. For ratings, and curves, refer to glass-octal type 35L6-GT. Type 35A5 is used principally for renewal purposes.

**35A5**

**BEAM POWER TUBE**

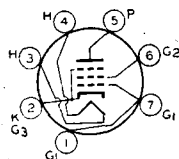

Miniature type used in output stage of compact, ac/dc radio receivers. Because of its high power sensitivity at plate and screen-grid voltages available in ac/dc receivers, it is capable of providing a relatively high power output.

**35B5**

Outline 13, OUTLINES SECTION. Tube requires miniature seven-contact socket and may be mounted in any position. Within its maximum ratings, type 35B5 is equivalent in performance to glass-octal type 35L6-GT, and miniature type 35C5. Refer to type 35C5 for typical operation, maximum circuit values, installation, application information, and curves.

HEATER VOLTS (AC/DC) .....	35	volts
HEATER CURRENT .....	0.15	ampere
DIRECT INTERELECTRODE CAPACITANCES (Approx.):		
Grid No.1 to Plate .....	0.7	$\mu\mu\text{f}$
Grid No.1 to Cathode, Heater, Grid No.2, and Grid No.3 .....	12	$\mu\mu\text{f}$
Plate to Cathode, Heater, Grid No.2, and Grid No.3 .....	9	$\mu\mu\text{f}$

**CLASS A<sub>1</sub> AMPLIFIER**

**Maximum Ratings:**

PLATE VOLTAGE .....	117 <i>max</i>	volts
GRID-NO.2 (SCREEN-GRID) VOLTAGE .....		
PLATE DISSIPATION .....	4.5 <i>max</i>	watts
GRID-NO.2 INPUT .....	1.0 <i>max</i>	watt
PEAK HEATER-CATHODE VOLTAGE:		
Heater negative with respect to cathode .....	150 <i>max</i>	volts
Heater positive with respect to cathode .....	150 <i>max</i>	volts

**BEAM POWER TUBE**

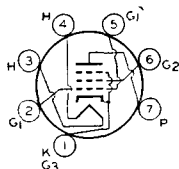

Miniature type used in output stage of compact, ac/dc radio receivers. Because of its high power sensitivity and high efficiency at plate and screen-grid voltages available in ac/dc receivers, the 35C5 is capable of providing a relatively high power output. Except

**35C5**

for terminal connections and slightly higher ratings, type 35C5 is equivalent in performance to miniature type 35B5 and, within its maximum ratings, to glass-octal type 35L6-GT. The basing arrangement of the 35C5 simplifies the problem of meeting Underwriters' Laboratories requirements in the design of ac/dc receivers.

HEATER VOLTAGE (AC/DC) .....	35	volts
HEATER CURRENT .....	0.15	ampere
DIRECT INTERELECTRODE CAPACITANCES (Approx.):		
Grid No.1 to Plate .....	0.7	$\mu\mu\text{f}$
Grid No.1 to Cathode, Heater, Grid No.2, and Grid No.3 .....	12.2	$\mu\mu\text{f}$
Plate to Cathode, Heater, Grid No.2, and Grid No.3 .....	9.0	$\mu\mu\text{f}$

**Maximum Ratings:**

**CLASS A<sub>1</sub> AMPLIFIER**

PLATE VOLTAGE .....	135 <i>max</i>	volts
GRID-NO.2 (SCREEN-GRID) VOLTAGE .....	117 <i>max</i>	volts
PLATE DISSIPATION .....	4.5 <i>max</i>	watts
GRID-NO.2 INPUT .....	1.0 <i>max</i>	watt

**PEAK HEATER-CATHODE VOLTAGE:**

Heater negative with respect to cathode.....	180 max	volts
Heater positive with respect to cathode.....	180 max	volts
<b>BULB TEMPERATURE (At hottest point on bulb surface).....</b>	<b>250 max</b>	<b>°C</b>

**Typical Operation:**

Plate Voltage.....	110	volts
Grid-No.2 Voltage.....	110	volts
Grid-No.1 (Control-Grid) Voltage.....	-7.5	volts
Peak AF Grid-No.1 Voltage.....	7.5	volts
Zero-Signal Plate Current.....	40	ma
Maximum-Signal Plate Current.....	41	ma
Zero-Signal Grid-No.2 Current (Approx.).....	3	ma
Maximum-Signal Grid-No.2 Current (Approx.).....	7	ma
Plate Resistance (Approx.).....	13000	ohms
Transconductance.....	5800	$\mu$ mhos
Load Resistance.....	2500	ohms
Total Harmonic Distortion.....	10	per cent
Maximum-Signal Power Output.....	1.5	watts

**Maximum Circuit Values (For maximum rated conditions):**

Grid-No.1-Circuit Resistance:		
For fixed-bias operation.....	0.1 max	megohm
For cathode-bias operation.....	0.5 max	megohm

## INSTALLATION AND APPLICATION

Type 35C5 requires miniature seven-contact socket and may be mounted in any position. Outline 13, OUTLINES SECTION. It is especially important that this tube, like other power-handling tubes, should be adequately ventilated.

The 35-volt heater is designed to operate under the normal conditions of line-voltage variation without materially affecting the performance or serviceability of the 35C5. For operation of the 35C5 in series with other types having 0.15-ampere rating, the current in the heater circuit should be adjusted to 0.15 ampere for the normal supply voltage.

In a series-heater circuit of the "dc power line" type employing several 0.15-ampere types and one or two 35C5's, the heater(s) of the 35C5(s) should be placed on the positive side of the line. Under these conditions, heater-cathode voltage of the 35C5 must not exceed the value given under maximum ratings. In a series-heater circuit of the "universal" type employing rectifier tube 35W4, one or two 35C5's and several 0.15-ampere types, it is recommended that the heater(s) of the 35C5(s) be placed in the circuit so that the higher values of heater-cathode bias will be impressed on the 35C5(s) rather than on the other 0.15-ampere types. This is accomplished by arranging the 35C5(s) on the side of the supply line which

AVERAGE PLATE CHARACTERISTICS  
PENTODE CONNECTION

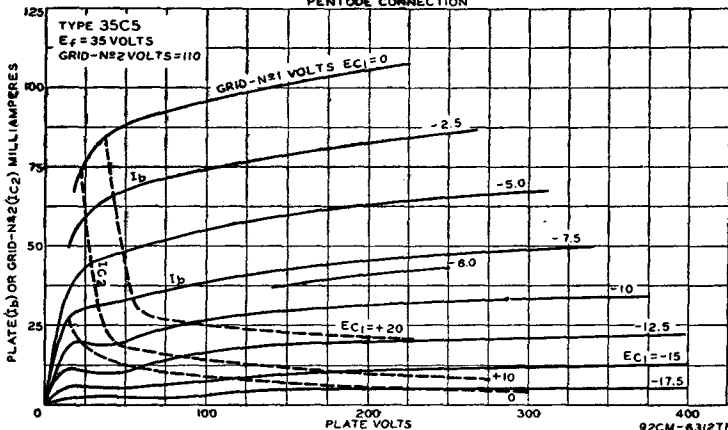



is connected to the cathode of the rectifier, i.e., the positive terminal of the rectified voltage supply. Between this side of the line and the 35C5('s), any necessary auxiliary resistance and the heater of the 35W4 are connected in series.

As a power amplifier (class A<sub>1</sub>), the 35C5 is recommended for use either singly or in push-pull combination in the power-output stage of "ac/dc" receivers. The operating values shown under typical operation have been determined on the basis that grid-No.1 current does not flow during any part of the input cycle.

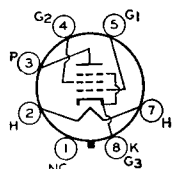

### BEAM POWER TUBE

Glass octal type used in output stage of ac/dc radio receivers. Outline 23, OUTLINES SECTION. Tube requires octal socket and may be mounted in any position. This type

may be supplied with pin No.1 omitted. Refer to miniature type 35C5 for installation, application information, and curves.

# 35L6-GT

HEATER VOLTAGE (AC/DC).....	35	volts
HEATER CURRENT.....	0.15	ampere
DIRECT INTERELECTRODE CAPACITANCES (Approx.):		
Grid No.1 to Plate.....	0.6	μf
Grid No.1 to Cathode, Heater, Grid No.2, and Grid No.3.....	13	μf
Plate to Cathode, Heater, Grid No.2, and Grid No.3.....	9.5	μf

#### Maximum Ratings:

#### CLASS A<sub>1</sub> AMPLIFIER

PLATE VOLTAGE.....	200 <i>max</i>	volts
GRID-NO.2 (SCREEN-GRID) VOLTAGE.....	117 <i>max</i>	volts
PLATE DISSIPATION.....	8.5 <i>max</i>	watts
GRID-NO.2 INPUT.....	1.0 <i>max</i>	watt
PEAK HEATER-CATHODE VOLTAGE:		
Heater negative with respect to cathode.....	150 <i>max</i>	volts
Heater positive with respect to cathode.....	150 <i>max</i>	volts

#### Typical Operation:

	<i>Fixed Bias</i>	<i>Cathode Bias</i>	
Plate Supply Voltage.....	110	200	volts
Grid-No.2 Supply Voltage.....	110	110	volts
Grid-No.1 (Control-Grid) Voltage.....	-7.5	-	volts
Cathode-Bias Resistor.....	-	180	ohms
Peak AF Grid-No.1 Voltage.....	7.5	8	volts
Zero-Signal Plate Current.....	40	43	ma
Maximum-Signal Plate Current.....	41	43	ma
Zero-Signal Grid-No.2 Current (Approx.).....	3	2	ma
Maximum-Signal Grid-No.2 Current (Approx.).....	7	5.5	ma
Plate Resistance (Approx.).....	14000	34000	ohms
Transconductance.....	5800	6100	μmhos
Load Resistance.....	2500	5000	ohms
Total Harmonic Distortion.....	10	10	per cent
Maximum-Signal Power Output.....	1.5	3.0	watts

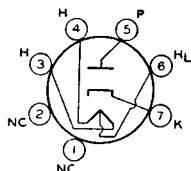

### HALF-WAVE VACUUM RECTIFIER

Miniature type used in power supply of ac/dc receivers. Equivalent in performance to glass-octal type 35Z5-GT. The heater is provided with a tap for operation of a panel lamp.

# 35W4

HEATER VOLTAGE (AC/DC):	*	**	
ENTIRE HEATER (PINS 3 AND 4).....	35	32	volts
PANEL LAMP SECTION (PINS 4 AND 6).....	7.5	5.5	volts
HEATER CURRENT:			
BETWEEN PINS 3 AND 4.....	0.15	-	ampere
BETWEEN PINS 3 AND 6.....	-	0.15	ampere

\* Without panel lamp.

\*\* With No.40 or No.47 panel lamp.

## Maximum Ratings:

HALF-WAVE RECTIFIER			
PEAK INVERSE PLATE VOLTAGE.....		330 max	volts
PEAK PLATE CURRENT.....		600 max	ma
DC OUTPUT CURRENT:			
With Panel Lamp and { No Shunting Resistor.....		60 max	ma
Without Panel Lamp { Shunting Resistor.....		90 max	ma
Without Panel Lamp.....		100 max	ma
PANEL-LAMP-SECTION VOLTAGE (rms):			
When Panel Lamp Fails.....		15 max	volts
PEAK HEATER-CATHODE VOLTAGE:			
Heater negative with respect to cathode.....		330 max	volts
Heater positive with respect to cathode.....		330 max	volts

## Typical Operation with Panel Lamp:†

AC Plate-Supply Voltage (rms).....	117	117	117	117	volts
Filter-Input Capacitor.....	40	40	40	40	μf
Minimum Total Effective Plate-Supply Impedance.....	15	15	15	15	ohms
Panel-Lamp Shunting Resistor.....	-	300	150	100	ohms
DC Output Current.....	60	70	80	90	ma

† No.40 or No.47 panel lamp used in circuit given below with capacitor-input filter.

## Typical Operation without Panel Lamp:

AC Plate-Supply Voltage (rms).....	117	volts
Filter-Input Capacitor.....	40	μf
Minimum Total Effective Plate-Supply Impedance.....	15	ohms
DC Output Current.....	100	ma
DC Output Voltage at Input to Filter (Approx.):		
At half-load current (50 ma.).....	135	volts
At full-load current (100 ma.).....	120	volts
Voltage Regulation (Approx.):		
Half-load to full-load current.....	15	volts

## Maximum Circuit Values:

### Panel-Lamp Shunting Resistor\*:

For dc output current of { 70 ma.....	800 max	ohms
{ 80 ma.....	400 max	ohms
{ 90 ma.....	250 max	ohms

\*Required when dc output current is greater than 60 milliamperes.

## INSTALLATION AND APPLICATION

Tube requires miniature seven-contact socket and may be mounted in any position. Outline 13, OUTLINES SECTION. For heater considerations, refer to miniature type 35C5.

With the panel lamp connected as shown in the diagram, the drop across R and all heaters (with panel lamp) should equal 117 volts at 0.15 ampere. The shunting resistor  $R_s$  is required when dc output current exceeds 60 milliamperes. Values of  $R_s$  for dc output currents greater than 60 milliamperes are given in tabulated data.

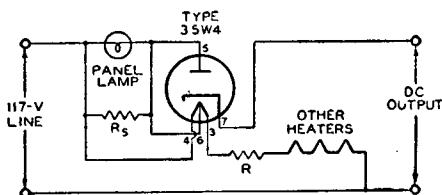
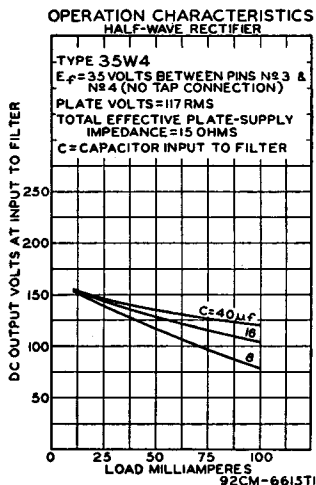

**HALF-WAVE VACUUM RECTIFIER**

Glass lock-in type used in power supply of ac/dc receivers. The heater is provided with tap for the operation of a panel lamp. Outline 20, OUTLINES SECTION. Tube requires lock-in socket. Heater volts (ac/dc), 35; amperes, 0.15. For maximum ratings, refer to glass-octal type 35Z5-GT. For typical operation and curves, refer to miniature type 35W4. Type 35Y4 is used principally for renewal purposes.

**35Y4**

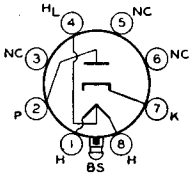

**HALF-WAVE VACUUM RECTIFIER**

Glass lock-in type used in power supply of ac/dc receivers. Outline 20, OUTLINES SECTION. Tube requires lock-in socket. Heater volts (ac/dc), 35; amperes, 0.15. For maximum ratings and typical operation, refer to glass-octal type 35Z5-GT without panel lamp. Type 35Z3 is used principally for renewal purposes.

**35Z3**

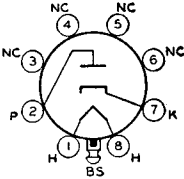

**HALF-WAVE VACUUM RECTIFIER**

Glass octal type used in power supply of ac/dc receivers. Outline 23, OUTLINES SECTION. Tube requires octal socket. This type may be supplied with pin No.1 omitted. Heater volts (ac/dc), 35; amperes, 0.15. For maximum ratings and typical operation, refer to glass-octal type 35Z5-GT without panel lamp. Type 35Z4-GT is used principally for renewal purposes.

**35Z4-GT**

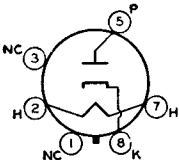

**HALF-WAVE VACUUM RECTIFIER**

Glass octal type used in power supply of ac/dc receivers. The heater is provided with a tap for operation of a panel lamp. Outline 23, OUTLINES SECTION. Tube requires octal socket and may be mounted in any position. This type may be supplied with pin No.1 omitted. For installation and application considerations, refer to miniature type 35W4.

**35Z5-GT**

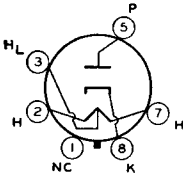

HEATER VOLTAGE (AC/DC):	*	**	
ENTIRE HEATER (PINS 2 AND 7) .....	35	32	volts
PANEL LAMP SECTION (PINS 2 AND 3) .....	7.5	5.5	volts
HEATER CURRENT:			
BETWEEN PINS 2 AND 7 .....	0.15	-	ampere
BETWEEN PINS 3 AND 7 .....	-	0.15	ampere

\* Without panel lamp.

\*\* With No.40 or No. 47 panel lamp.

**HALF-WAVE RECTIFIER**

**Maximum Ratings:**

PEAK INVERSE PLATE VOLTAGE .....	700 maz	volts
PEAK PLATE CURRENT .....	600 maz	ma
DC OUTPUT CURRENT:		
With Panel Lamp and { No Shunting Resistor .....	60 maz	ma
Without Panel Lamp. { Shunting Resistor .....	90 maz	ma
Without Panel Lamp .....	100 maz	ma
PANEL-LAMP-SECTION VOLTAGE (rms):		
When Panel Lamp Fails .....	15 maz	volts
PEAK HEATER-CATHODE VOLTAGE:		
Heater negative with respect to cathode .....	350 maz	volts
Heater positive with respect to cathode .....	350 maz	volts

## Typical Operation with Panel Lamp:†

AC Plate-Supply Voltage (rms) . . . . .	117	117	117	117	235	volts
Filter-Input Capacitor . . . . .	40	40	40	40	40	μf
Minimum Total Effective Plate-Supply Impedance . . . . .	15	15	15	15	100	ohms
Panel-Lamp Shunting Resistor . . . . .	-	300	150	100	-	ohms
DC Output Current . . . . .	60	70	80	90	60	ma

† No.40 or No.47 panel lamp used in circuit with capacitor-input filter given under type 35W4.

## Typical Operation without Panel Lamp:

AC Plate-Supply Voltage (rms) . . . . .	117	235	volts
Filter-Input Capacitor . . . . .	40	40	μf
Minimum Total Effective Plate-Supply Impedance . . . . .	15	100	ohms
DC Output Current . . . . .	100	100	ma
DC Output Voltage at Input to Filter (Approx.):			
At half-load current (50 ma.) . . . . .	140	280	volts
At full-load current (100 ma.) . . . . .	120	235	volts
Voltage Regulation (Approx.):			
Half-load to full-load current . . . . .	20	45	volts

## Maximum Circuit Values:

### Panel-Lamp Shunting Resistor\*:

For dc output current of	{ 70 ma . . . . .	800 max	ohms
	{ 80 ma . . . . .	400 max	ohms
	{ 90 ma . . . . .	250 max	ohms

\* Required when dc output current is greater than 60 milliamperes.

36

## SHARP-CUTOFF TETRODE

Glass type used as rf or if amplifier or as biased or grid-resistor detector in radio receivers. Outline 39, OUTLINES SECTION. Tube requires five-contact socket. Heater volts (ac/dc), 6.3; amperes, 0.3. Characteristics as class A<sub>1</sub> amplifier: plate volts, 250 max; grid-No.2 volts, 90 max; grid-No.1 volts, -3; plate ma., 3.2; grid-No.2 ma., 1.7 max; plate resistance, 0.55 megohm; transconductance, 1080 μmhos. This is a DISCONTINUED type listed for reference only.

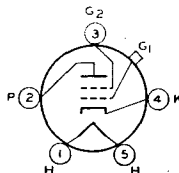

ance, 0.55 megohm; transconductance, 1080 μmhos. This is a DISCONTINUED type listed for reference only.

37

## MEDIUM-MU TRIODE

Glass type used as voltage amplifier or detector in radio receivers. Outline 34 or 35, OUTLINES SECTION. Tube requires five-contact socket. Heater volts (ac/dc), 6.3; amperes, 0.3. Characteristics as class A<sub>1</sub> amplifier: plate volts, 250 max; grid volts, -18; plate ma., 7.5; plate resistance, 8400 ohms; amplification factor, 9.2; transconductance, 1100 μmhos. This is a DISCONTINUED type listed for reference only.

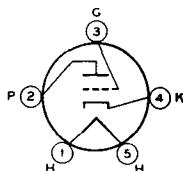

38

## POWER PENTODE

Glass type used in output stage of radio receivers. Outline 39, OUTLINES SECTION. Tube requires five-contact socket. Heater volts (ac/dc), 6.3; amperes, 0.3. Characteristics as class A<sub>1</sub> amplifier: plate and grid-No.2 volts, 250 max; grid-No.1 volts, -25; plate ma., 22; grid-No.2 ma., 3.8; plate resistance, 0.1 megohm; transconductance, 1200 μmhos; load resistance, 10000 ohms; output watts, 2.5. This is a DISCONTINUED type listed for reference only.

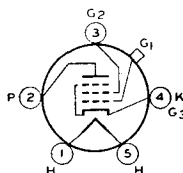

39/44

## REMOTE-CUTOFF PENTODE

Glass type used as rf or if amplifier in radio receivers, particularly those employing avc. Outline 39, OUTLINES SECTION. Tube requires five-contact socket. Heater volts (ac/dc), 6.3; amperes, 0.3. Characteristics as class A<sub>1</sub> amplifier: plate volts, 250 max; grid-No.2 volts, 90 max; grid-No.1 volts, -3 min; plate ma., 5.8; grid-No.2 ma., 1.4; plate resistance, 1.0 meg-

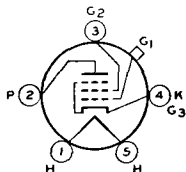

ohm; transconductance, 1050 μmhos; transconductance at grid-No.1 bias of -42.5 volts, 2 μmhos. This is a DISCONTINUED type listed for reference only.

## MEDIUM-MU TRIODE

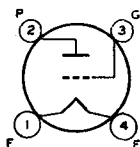

Glass type used as resistance-coupled or impedance-coupled amplifier in battery-operated receivers. Outline 42, OUTLINES SECTION. Filament volts (dc), 5; amperes, 0.25. Characteristics as class A<sub>1</sub> amplifier: plate-supply volts, 180; load resistance, 250000 ohms; grid volts, -3; plate ma., 0.2; plate resistance, 150000 ohms; amplification factor, 30; transconductance, 200  $\mu$ hos. This is a DISCONTINUED type listed for reference only.

40

## POWER PENTODE

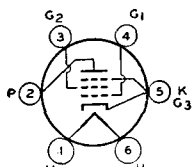

Glass type used in output stage of radio receivers. Outline 34 or 35, OUTLINES SECTION. Tube requires six-contact socket. Heater volts (ac/dc), 6.3; amperes, 0.4. This type is electrically identical with type 6K6-GT. Type 41 is used principally for renewal purposes.

41

## POWER PENTODE

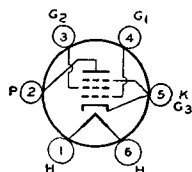

Glass type used in audio output stage of ac receivers. Outline 42, OUTLINES SECTION. Tube requires six-contact socket. Heater volts (ac/dc), 6.3; amperes, 0.7. This type is electrically identical with type 6F6. Type 42 is used principally for renewal purposes.

42

## POWER PENTODE

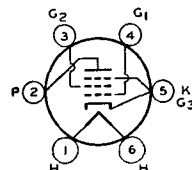

Glass type used in audio output stage of ac/dc receivers. Outline 42, OUTLINES SECTION. Tube requires six-contact socket. Heater volts (ac/dc), 25; amperes, 0.3. This type is electrically identical with type 25A6. Type 43 is used principally for renewal purposes.

43

## POWER TRIODE

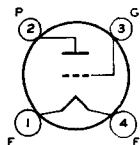

Glass type used in output stage of radio receivers. Outline 42, OUTLINES SECTION. Tube requires four-contact socket and should preferably be mounted in vertical position. Horizontal operation is permissible if pins 1 and 4 are in vertical plane. Filament volts (ac/dc), 2.5; amperes, 1.5. This type is used principally for renewal purposes.

45

### Typical Operation:

### CLASS A<sub>1</sub> AMPLIFIER

Plate Supply Voltage (275 volts max) . . . . .	180	250	275	
Grid Voltage* . . . . .	-31.5	-50	-56	volts
Cathode-Bias Resistor . . . . .	1020	1470	1550	ohms
Plate Current . . . . .	31	34	36	ma
Plate Resistance . . . . .	1650	1610	1700	ohms
Amplification Factor . . . . .	3.5	3.5	3.5	
Transconductance . . . . .	2125	2175	2050	$\mu$ hos
Load Resistance . . . . .	2700	3900	4600	ohms
Undistorted Power Output . . . . .	0.825	1.6	2.0	watts

\* Grid volts measured from mid-point of ac-operated filament. Cathode-resistor bias is advisable in all cases, required if grid-coupling resistor (max value of 1.0 megohm) is used.

## HALF-WAVE VACUUM RECTIFIER

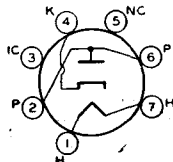

Miniature type used in power supply of small, portable, ac/dc/battery receivers where small size and low heat dissipation are important. Outline 11, OUTLINES SECTION. Tube requires miniature seven-contact socket and may be mounted in any position. Heater volts (ac/dc) 45; amperes, 0.075. Maximum ratings: peak inverse plate volts, 350 max; peak plate

45Z3

ma., 390 max; dc output ma., 65 max; peak heater-cathode volts, 175 max. Typical operation with capacitor-input filter: ac plate volts (rms), 117; minimum total effective plate-supply impedance, 15 ohms; dc output ma. 65. This is a DISCONTINUED type listed for reference only.

## HALF-WAVE VACUUM RECTIFIER

Glass octal type used in power supply of ac/dc receivers. The heater is provided with a tap for operation of a panel lamp. Outline 23, OUTLINES SECTION. Tube requires octal socket. This type may be supplied with pin No.1 omitted. Except for difference in heater voltage, this type has the same ratings and typical operation values as glass-octal type 35Z5-GT. Type 45Z5-GT is a DISCONTINUED type listed for reference only.

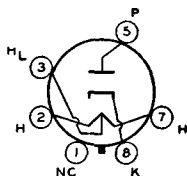

### 45Z5-GT

<b>HEATER VOLTAGE (AC/DC):</b>	*	**	
ENTIRE HEATER (PINS 2 AND 7).....	45	42	volts
PANEL LAMP SECTIONS (PINS 2 AND 3).....	7.5	5.5	volts
<b>HEATER CURRENT:</b>			
BETWEEN PINS 2 AND 7.....	0.15	-	ampere
BETWEEN PINS 3 AND 7.....	-	0.15	ampere

\* Without panel lamp.

\*\* With No. 40 or No.47 panel lamp.

## DUAL-GRID POWER AMPLIFIER

Glass type used as class A<sub>1</sub> or class B amplifier in radio equipment. Outline 52, OUTLINES SECTION. Tube requires five-contact socket. Filament volts (ac/dc), 2.5; amperes, 1.75. Typical operation as class A<sub>1</sub> amplifier (grid No.2 connected to plate at socket): plate volts, 250 *max*; grid volts, -33; plate ma., 22; plate resistance, 2380 ohms; am-

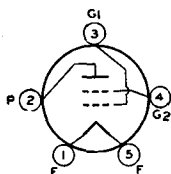

### 46

plification factor, 5.6; transconductance, 2350  $\mu$ mhos; load resistance for maximum undistorted power output, 6400 ohms; undistorted output watts, 1.25. This is a DISCONTINUED type listed for reference only.

## POWER PENTODE

Glass type used in audio output stage of radio receivers. Outline 52, OUTLINES SECTION. Tube requires five-contact socket and should preferably be mounted in vertical position. Horizontal operation is permissible if pins 1 and 5 are in vertical plane. Filament volts (ac/dc), 2.5; amperes, 1.75. Typical operation as class A<sub>1</sub> amplifier: plate and grid-No.2 volts,

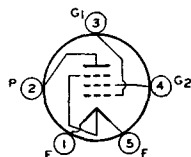

### 47

250 *max*; cathode-bias resistor, 450 ohms; plate ma., 31; grid-No.2 ma., 6; plate resistance, 60000 ohms; transconductance, 2500  $\mu$ mhos; load resistance, 7000 ohms; power output, 2.7 watts. This type is used principally for renewal purposes.

## POWER TETRODE

Glass type used in audio output stage of radio receivers designed to operate from dc powerlines. Outline 52, OUTLINES SECTION. Heater volts (dc), 30; amperes, 0.4. Typical operation as class A<sub>1</sub> amplifier: plate volts, 125 *max*; grid-No.2 volts, 100 *max*; grid-No.1 volts, -20; plate ma., 56; grid-No.2 ma., 9.5; transconductance, 3900  $\mu$ mhos; load resistance, 1500 ohms; output watts, 2.5. This is a DISCONTINUED type listed for reference only.

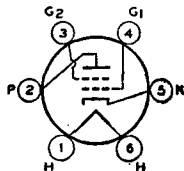

### 48

## DUAL-GRID POWER AMPLIFIER

Glass type used in output stage of battery-operated receivers. Outline 42, OUTLINES SECTION. Tube requires five-contact socket. Filament volts (dc), 2.0; amperes, 0.12. Typical operation as class A<sub>1</sub> amplifier (grid No.2 connected to plate at socket): plate volts, 135 *max*; grid volts, -20; plate ma., 6; plate resistance, 4175 ohms; amplification factor, 4.7; transconductance, 1125  $\mu$ mhos; load resistance, 11000 ohms; output watts (approx.), 0.17. This is a DISCONTINUED type listed for reference only.

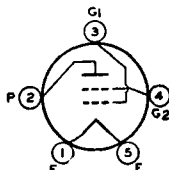

### 49

**POWER TRIODE**

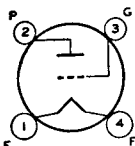

**50**

Glass type used in output stage of af amplifiers employing transformer input coupling. Maximum over-all length, 6-1/4 inches; maximum diameter, 2-7/16 inches. Tube requires four-contact socket and should be mounted in vertical position with base down. Filament volts (ac/dc), 7.5; amperes, 1.25. Characteristics as Class A<sub>1</sub> amplifier: plate volts, 450 *max*; grid volts, -84; cathode resistor, 1530 ohms; plate *ma.*, 55; plate resistance, 1800 ohms; amplification factor, 3.8; transconductance, 2100  $\mu$ mhos; load resistance, 4350 ohms; output watts, 4.6. Resistance in grid-coupling circuit should not exceed 10000 ohms. This is a DISCONTINUED type listed for reference only.

**BEAM POWER TUBE**

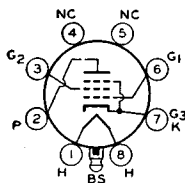

**50A5**

Glass lock-in type used in output stage of ac/dc receivers. Outline 20, OUTLINES SECTION. Tube requires lock-in socket. Heater volts (ac/dc), 50; amperes, 0.15. For ratings and data, refer to glass-octal type 50L6-GT. Type 50A5 is used principally for renewal purposes.

**BEAM POWER TUBE**

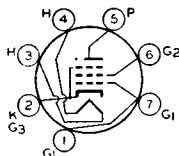

**50B5**

Miniature type used in output stage of compact ac/dc receivers. Because of its high power sensitivity at plate and screen-grid voltages available in ac/dc receivers, it is capable of providing a relatively high power output. Outline 13, OUTLINES SECTION. Tube requires miniature seven-contact socket and may be mounted in any position. Except for basing arrangement, type 50B5 is identical with miniature type 50C5.

**BEAM POWER TUBE**

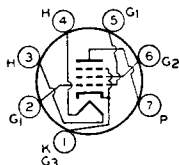

**50C5**

Miniature type used in output stage of compact, ac/dc radio receivers. Because of its high power sensitivity and high efficiency at plate and screen-grid voltages available in ac/dc receivers, the 50C5 is capable of providing a relatively high power output.

Within its maximum ratings, type 50C5 is equivalent in performance to glass-octal type 50L6-GT. The basing arrangement of the 50C5 simplifies the problem of meeting Underwriters' Laboratories requirements in the design of ac/dc receivers.

HEATER VOLTAGE (AC/DC) .....	50	volts
HEATER CURRENT .....	0.15	ampere
<b>DIRECT INTERELECTRODE CAPACITANCES (Approx.):</b>		
Grid No.1 to Plate .....	0.7	$\mu$ f
Grid No.1 to Cathode, Heater, Grid No.2, and Grid No.3. ....	13	$\mu$ f
Plate to Cathode, Heater, Grid No.2, and Grid No.3. ....	9	$\mu$ f

**CLASS A<sub>1</sub> AMPLIFIER**

<b>Maximum Ratings:</b>		
PLATE VOLTAGE .....	135 <i>max</i>	volts
GRID-NO.2 (SCREEN-GRID) VOLTAGE .....	117 <i>max</i>	volts
PLATE DISSIPATION .....	5.5 <i>max</i>	watts
GRID-NO.2 INPUT .....	1.25 <i>max</i>	watts
<b>PEAK HEATER-CATHODE VOLTAGE:</b>		
Heater negative with respect to cathode .....	180 <i>max</i>	volts
Heater positive with respect to cathode .....	180 <i>max</i>	volts
BULB TEMPERATURE (At hottest point on bulb surface) .....	250 <i>max</i>	°C

## Typical Operation:

Plate Voltage	110	volts
Grid-No.2 Voltage	110	volts
Grid-No.1 (Control-Grid) Voltage	-7.5	volts
Peak AF Grid-No.1 Voltage	7.5	volts
Zero-Signal Plate Current	49	ma
Maximum-Signal Plate Current	50	ma
Zero-Signal Grid-No.2 Current (Approx.)	4	ma
Maximum-Signal Grid-No.2 Current (Approx.)	8.5	ma
Plate Resistance (Approx.)	10000	ohms
Transconductance	7500	$\mu$ hos
Load Resistance	2500	ohms
Total Harmonic Distortion	9	per cent
Maximum-Signal Power Output	1.9	watts

## Maximum Circuit Values (For maximum rated conditions):

Grid-No.1-Circuit Resistance:		
For fixed-bias operation	0.1 max	megohm
For cathode-bias operation	0.5 max	megohm

## INSTALLATION AND APPLICATION

Type 50C5 requires miniature seven-contact socket and may be mounted in any position. Outline 13, OUTLINES SECTION. It is especially important that this tube, like other power-handling tubes, be adequately ventilated.

The 50-volt heater is designed to operate under the normal conditions of line-voltage variation without materially affecting the performance or serviceability of the 50C5. For operation of the 50C5 in series with other types having 0.15-ampere rating, the current in the heater circuit should be adjusted to 0.15 ampere for the normal supply voltage.

In a series-heater circuit of the "dc power line" type employing several 0.15-ampere types and one or two 50C5's, the heater(s) of the 50C5('s) should be placed on the positive side of the line. Under these conditions, heater-cathode voltage of the 50C5 must not exceed the value given under maximum ratings. In a series-heater circuit of the "universal" type employing rectifier tube 35W4, one or two 50C5's, and several 0.15-ampere types, it is recommended that the heater(s) of the 50C5('s) be placed in the circuit so that the higher values of heater-cathode bias will be impressed on the 50C5('s) rather than on the other 0.15-ampere types. This is accomplished by arranging the 50C5('s) on the side of the supply line which is connected to the cathode of the rectifier, i.e., the positive terminal of the rectified

AVERAGE PLATE CHARACTERISTICS  
PENTODE CONNECTION

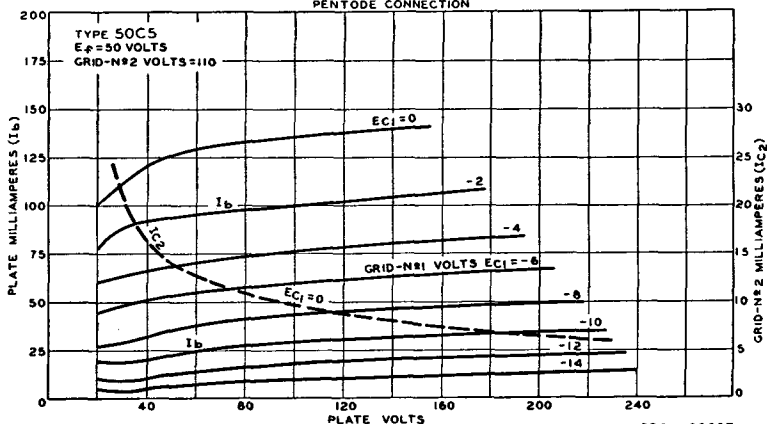



voltage supply. Between this side of the line and the 50C5(s), any necessary auxiliary resistance and the heater of the 35W4 are connected in series.

As a power amplifier (class A<sub>1</sub>), the 50C5 is recommended for use either singly or in push-pull combination in the power-output stage of "ac/dc" receivers. The operating values shown under typical operation have been determined on the basis that grid-No.1 current does not flow during any part of the input cycle.

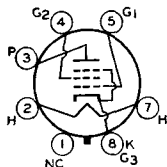

## BEAM POWER TUBE

Glass octal type used in output stage of ac/dc receivers. Outline 41, OUTLINES SECTION. Heater volts (ac/dc), 50; amperes, 0.15. Except for heater rating, this type is identical with glass octal type 6Y6-G. Type 50C6-G is used principally for renewal purposes.

# 50C6-G

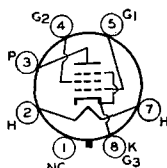

## BEAM POWER TUBE

Glass octal type used in output stage of ac/dc radio receivers. Outline 23, OUTLINES SECTION. Tube requires octal socket and may be mounted in any position. This type may be supplied with pin No.1 omitted.

# 50L6-GT

Refer to miniature type 50C5 for curves and installation and application information.

HEATER VOLTAGE (AC/DC) .....	50	volts
HEATER CURRENT .....	0.15	ampere
DIRECT INTERELECTRODE CAPACITANCES (Approx.):		
Grid No.1 to Plate .....	0.6	μf
Grid No.1 to Cathode, Heater, Grid No.2, and Grid No.3 .....	15	μf
Plate to Cathode, Heater, Grid No.2, and Grid No.3 .....	9.5	μf

## CLASS A<sub>1</sub> AMPLIFIER

<b>Maximum Ratings:</b>		
PLATE VOLTAGE .....	200 max	volts
GRID-NO.2 (SCREEN-GRID) VOLTAGE .....	125 max	volts
PLATE DISSIPATION .....	10 max	watts
GRID-NO.2 INPUT .....	1.25 max	watts
PEAK HEATER-CATHODE VOLTAGE:		
Heater negative with respect to cathode .....	150 max	volts
Heater positive with respect to cathode .....	150 max	volts

<b>Typical Operation:</b>			
Plate Supply Voltage .....	Fixed Bias	Cathode Bias	
Grid-No.2 Supply Voltage .....	110	200	volts
Grid-No.1 (Control-Grid) Voltage .....	-11.0	125	volts
Peak AF Grid-No.1 Voltage .....	-7.5	-	volts
Cathode-Bias Resistor .....	7.5	8.0	volts
Zero-Signal Plate Current .....	-	180	ohms
Maximum-Signal Plate Current .....	49	46	ma
Zero-Signal Grid-No.2 Current (Approx.) .....	50	47	ma
Maximum-Signal Grid-No.2 Current (Approx.) .....	4	2.2	ma
Plate Resistance (Approx.) .....	10	8.5	ma
Transconductance .....	13000	28000	ohms
Load Resistance .....	8000	8000	μmhos
Total Harmonic Distortion .....	2000	4000	ohms
Maximum-Signal Power Output .....	10	10	per cent
	2.1	3.8	watts

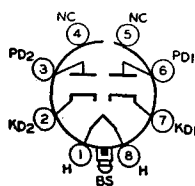

## VACUUM RECTIFIER-DOUBLER

Lock-in type used as half-wave rectifier or voltage doubler in ac/dc receivers. Outline 20, OUTLINES SECTION. Tube requires lock-in socket. Heater volts (ac/dc), 50; amperes, 0.15. This type is electrically identical with glass-octal type 50Y6-GT and, except for heater rating, with glass-octal type 25Z6-GT. Refer to type 25Z6-GT for maximum ratings, typical operation, and curves. Type 50X6 is used principally for renewal purposes.

# 50X6

**VACUUM RECTIFIER-DOUBLER**

**50Y6-GT**

Glass octal type used as half-wave rectifier or voltage doubler in ac/dc receivers. This type is used particularly in "transformerless" receivers of either the ac/dc type or the voltage-doubler type. Outline 23, OUTLINES

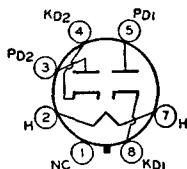

SECTION. This type may be supplied with pin No.1 omitted. Tube requires octal socket. Heater volts (ac/dc), 50; amperes, 0.15. Except for heater rating, this type is electrically identical with type 25Z6-GT.

**VACUUM RECTIFIER-DOUBLER**

**50Y7-GT**

Glass octal type used as half-wave rectifier or voltage doubler in ac/dc receivers. This type is used particularly in "transformerless" receivers of either the ac/dc type or the voltage-doubler type. The heater is provided with a tap for operation of a panel lamp. Outline 23, OUTLINES SECTION. Tube requires octal socket.

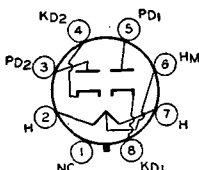

For maximum ratings and typical operation as

half-wave rectifier or voltage doubler without panel lamp, refer to glass octal type 25Z6-GT. When operated with a panel lamp and 250-ohm panel-lamp shunting resistor, ratings and typical operation are the same as for type 25Z6-GT, except that dc output current per plate is 65 ma. Type 50Y7-GT is used principally for renewal purposes.

HEATER VOLTAGE (AC/DC):	*	**	
ENTIRE HEATER (PINS 2 AND 7).....	50	46	volts
PANEL LAMP SECTION (PINS 6 AND 7).....	7.5	5.5	volts
<b>HEATER CURRENT:</b>			
BETWEEN PINS 2 AND 7.....	0.15	-	ampere
BETWEEN PINS 2 AND 6.....	-	0.15	ampere

\* Without panel lamp. \*\* With No. 40 or No. 47 panel lamp.

**VACUUM RECTIFIER-DOUBLER**

**50Z7-G**

Glass octal type used as half-wave rectifier or voltage doubler in ac/dc receivers. Outline 36, OUTLINES SECTION. The heater is provided with a tap for operation of a panel lamp. Without panel lamp, heater volts (ac/dc) of entire heater (pins 2 and 7), 50; amperes, 0.15. With panel lamp, heater volts (ac/dc) of panel-lamp section (pins 6 and 7 with 0.15 ampere

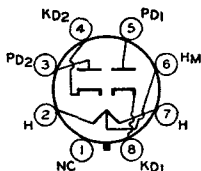

between pins 2 and 7), 2. Maximum ratings as rectifier or doubler: peak inverse plate volts, 700 max; peak plate ma. per plate, 400 max; dc output ma. per plate with panel lamp, 65 max; peak heater-cathode volts, 350 max; panel lamp section volts (pins 6 and 7), 2.5 max. This is a DISCONTINUED type listed for reference only.

**HIGH-MU TWIN POWER TRIODE**

**53**

Glass type used in output stage of ac-operated receivers as a class B power amplifier. Outline 42, OUTLINES SECTION. Tube requires medium seven-contact (0.855-inch pin-circle diameter) socket. Heater volts (ac/dc), 2.5; amperes, 2.0. Except for heater rating, this type is electrically identical with metal type 6N7. Type 53 is a DISCONTINUED type listed for reference only.

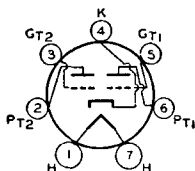

**TWIN DIODE—MEDIUM-MU TRIODE**

**55**

Glass type used as a combined detector, amplifier, and avc tube. Outline 39, OUTLINES SECTION. Tube requires six-contact socket. Heater volts (ac/dc), 2.5; amperes, 1.0. Except for heater rating, this type is electrically identical with glass type 85. Type 55 is a DISCONTINUED type listed for reference only.

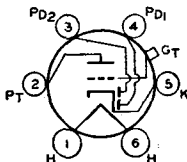

**MEDIUM-MU TRIODE**

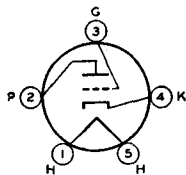

Glass type used as detector, amplifier, or oscillator in ac-operated receivers. Outline 34 or 35, OUTLINES SECTION. Tube requires five-contact socket. Heater volts (ac/dc), 2.5; amperes, 1.0. Except for heater rating, this type is electrically identical with glass type 76. Type 56 is a DISCONTINUED type listed for reference only.

56

**SHARP-CUTOFF PENTODE**

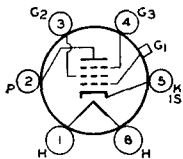

Glass type used as biased detector in ac-operated receivers. Outline 44, OUTLINES SECTION. Tube requires six-contact socket. Heater volts (ac/dc), 2.5; amperes, 1.0. Except for heater rating and capacitances, this type is electrically identical with metal type 6J7. Type 57 is a DISCONTINUED type listed for reference only.

57

**REMOTE-CUTOFF PENTODE**

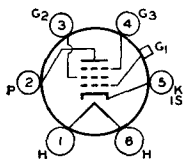

Glass type used in rf and if stages of radio receivers employing avc and as a mixer in superheterodyne circuits. Outline 44, OUTLINES SECTION. Tube requires six-contact socket. Heater volts (ac/dc), 2.5; amperes, 1.0. Except for heater ratings, this type is electrically identical with glass-octal type 6U7-G. Type 58 is a DISCONTINUED type listed for reference only.

58

**TRIPLE-GRID POWER AMPLIFIER**

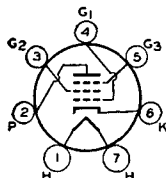

Glass type used in audio output stage of ac-operated receivers. Outline 52, OUTLINES SECTION. Tube requires medium seven-contact (0.855-inch, pin-circle diameter) socket. Heater volts (ac/dc), 2.5; amperes, 2.0. Typical operation as class A<sub>1</sub> amplifier (triode connection; grids No.2 and No.3 tied to plate); plate volts, 250 max; grid volts, -28; plate ma., 26;

59

plate resistance, 2300 ohms; amplification factor, 6; transconductance, 2600; load resistance for maximum undistorted power output, 5000 ohms; undistorted output watts, 1.25. For typical operation as class A<sub>1</sub> amplifier (pentode connection; grid No.3 tied to cathode at socket), refer to type 6F6 with plate voltage of 250 volts. Type 59 is a DISCONTINUED type listed for reference only.

**RECTIFIER—BEAM POWER TUBE**

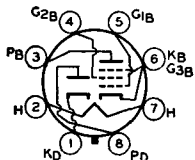

Glass octal type used as combined half-wave rectifier and output amplifier in ac/dc receivers. Outline 27, OUTLINES SECTION. Tube requires octal socket. Heater volts (ac/dc), 70; amperes, 0.15. Maximum ratings of rectifier unit: peak inverse plate volts, 350; peak plate ma., 420; dc output ma., 70; peak heater-cathode volts, 175; minimum total effective

70L7-GT

plate-supply impedance, 15 ohms. Typical operation and maximum ratings of beam power unit as class A<sub>1</sub> amplifier: plate and grid-No.2 volts, 110 (117 max); grid-No.1 volts, -7.5; plate ma., 40; grid-No.2 ma., 3; plate resistance, 15000 ohms; transconductance, 7500 μmhos; load resistance, 2000 ohms; output watts, 1.8; plate dissipation, 5 max watts; grid-No.2 input, 1 max watt. This type is used principally for renewal purposes.

**POWER TRIODE**

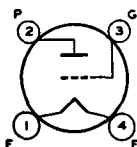

Glass type used in output stage of audio-frequency amplifiers. Outline 42, OUTLINES SECTION. Tube requires four-contact socket. Filament volts (ac/dc), 5.0; amperes, 0.25. Characteristics as class A<sub>1</sub> amplifier: plate volts, 180 max; grid volts, -40.5; cathode resistor, 2150 ohms; plate ma., 20; plate resistance, 1750 ohms; amplification factor, 3; transconductance,

71-A

1700 μmhos; load resistance, 4800 ohms; undistorted output watts, 0.79. This is a DISCONTINUED type listed for reference only.

75

**TWIN DIODE—HIGH-MU TRIODE**

Glass type used as combined detector, amplifier, and avc tube in radio receivers. Outline 39, OUTLINES SECTION. Tube requires six-contact socket. Heater volts (ac/dc), 6.3; amperes, 0.3. Except for interelectrode capacitances and plate volts of 250 *max*, this type is identical electrically with metal type 6SQ7. Type 75 is used principally for renewal purposes.

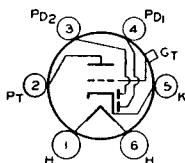

76

**MEDIUM-MU TRIODE**

Glass type used as voltage amplifier or detector in radio receivers. Outline 34 or 35, OUTLINES SECTION. Tube requires five-contact socket. Heater volts (ac/dc), 6.3; amperes, 0.3. Characteristics as class A<sub>1</sub> amplifier: plate volts, 250 *max*; grid volts, -13.5; plate ma., 5; plate resistance, 9500 ohms; transconductance, 1450  $\mu$ mhos. This is a DISCONTINUED type listed for reference only.

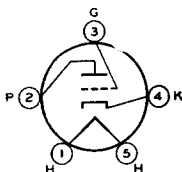

77

**SHARP-CUTOFF PENTODE**

Glass type used as biased detector or high-gain amplifier in radio receivers. Outline 39, OUTLINES SECTION. Tube requires six-contact socket. Heater volts (ac/dc), 6.3; amperes, 0.3. Except for capacitances and grid-No. 2 rating of 100 *max* volts, type 77 is electrically identical with metal type 6J7. Type 77 is used principally for renewal purposes.

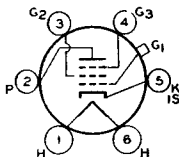

78

**REMOTE-CUTOFF PENTODE**

Glass type used in rf and if stages of radio receivers, particularly those employing avc. Outline 39, OUTLINES SECTION. Tube requires six-contact socket. Heater volts (ac/dc), 6.3; amperes, 0.3. Except for capacitances, this type is identical electrically with metal type 6K7. Type 78 is used principally for renewal purposes.

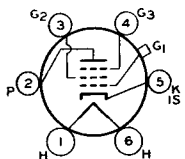

79

**HIGH-MU TWIN POWER TRIODE**

Glass type used in output stage of radio receivers as a class B power amplifier or a class A<sub>1</sub> driver. Outline 39, OUTLINES SECTION. Tube requires six-contact socket. Heater volts (ac/dc), 6.3; amperes, 0.6. Maximum ratings and typical operation as class B power amplifier: plate volts, 250 *max*; grid volts, 0; zero-signal plate ma., 10.5; effective load resistance (plate-to-plate), 14000 ohms; output watts (approx.), 8; peak plate ma. per plate, 90 *max*; average plate dissipation, 11.5 watts *max*. This is a DISCONTINUED type listed for reference only.

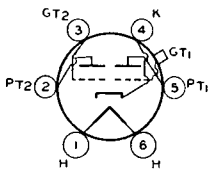

80

**FULL-WAVE VACUUM RECTIFIER**

Glass type used in power supply of radio equipment having moderate direct-current requirements. Outline 42, OUTLINES SECTION. Tube requires four-contact socket and should be mounted preferably in a vertical position. Horizontal mounting is permissible if pins 1 and 4 are in a horizontal plane. Filament volts (ac), 5.0; amperes, 2.0. For filament operation, refer to type 5U4-G. Type 80 is electrically identical with glass-octal type 5Y3-GT. Type 80 is used principally for renewal purposes.

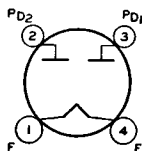

### HALF-WAVE VACUUM RECTIFIER

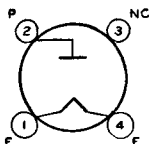

Glass type used in power supply of radio receivers. Maximum over-all length, 6-1/4 inches; maximum diameter, 2-7/16 inches. Tube requires four-contact socket and should be mounted preferably in a vertical position. Horizontal mounting is permissible if pins 1 and 4 are in a vertical plane. Filament volts (ac), 7.5; amperes,

81

1.25. Ratings as half-wave rectifier: peak inverse plate volts, 2000 *max*; peak plate ma., 500 *max*; dc output ma., 85 *max*. This is a DISCONTINUED type listed for reference only.

### FULL-WAVE MERCURY-VAPOR RECTIFIER

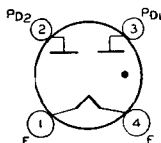

Glass type used to supply dc power of uniform voltage to receivers in which the rectified current requirements are subject to considerable variation. Outline 42, OUTLINES SECTION. Tube requires four-contact socket and should be mounted in vertical position with base down. Filament volts (ac), 2.5; amperes, 3. Maximum ratings for full-wave rectifier service: peak in-

82

verse plate volts, 1550 *max*; peak plate ma. per plate, 600; dc output ma., 115 *max*; condensed-mercury temperature range, 24 to 60°C. This is a DISCONTINUED type listed for reference only.

### FULL-WAVE VACUUM RECTIFIER

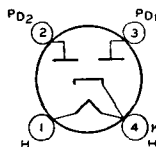

Glass type used in power supply of radio equipment having high dc requirements. Outline 42, OUTLINES SECTION. Tube requires four-contact socket. Heater volts (ac), 5.0; amperes, 2. This type is identical electrically with glass-octal type 5V4-G. Type 83-v is used principally for renewal purposes.

83-v

### FULL-WAVE VACUUM RECTIFIER

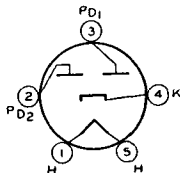

Glass type used in power supply of automobile and ac-operated radio receivers. Outline 34 or 35, OUTLINES SECTION. Tube requires five-contact socket. Heater volts (ac/dc), 6.3; amperes, 0.5. Maximum ratings: peak inverse plate volts, 1250 *max*; peak plate ma., 180 *max*; dc output ma., 60 *max*; peak heater-cathode volts, 450 *max*. Typical operation with capaci-

84/6Z4

tor-input filter: ac plate-to-plate supply volts (rms), 650; minimum total effective plate-supply impedance per plate, 150 ohms; dc output ma., 60. Typical operation with choke-input filter: ac plate-to-plate supply volts (rms), 900; minimum filter-input choke, 10 henries; dc output ma., 60. This type is used principally for renewal purposes.

### TWIN DIODE—MEDIUM-MU TRIODE

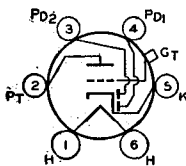

Glass type used as a combined detector, amplifier, and avc tube. Outline 39, OUTLINES SECTION. Tube requires six-contact socket. Heater volts (ac/dc), 6.3; amperes, 0.3. Characteristics of triode unit as class A<sub>1</sub> amplifier: plate volts, 250 *max*; grid volts, -20; amplification factor, 8.3; transconductance, 1100  $\mu$ mhos; pplate ma., 8.0; plate resistance, 7500 ohms; load

85

resistance, 20000 ohms; output watts, 0.35. This is a DISCONTINUED type listed for reference only.

### TRIPLE-GRID POWER AMPLIFIER

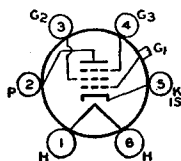

Glass type used in output stage of radio receivers. Outline 35, OUTLINES SECTION. Tube requires six-contact socket. Heater volts (ac/dc), 6.3; amperes, 0.4. Maximum ratings as class B amplifier (triode connection): plate volts, 250 *max*; peak plate ma. per tube, 90 *max*; average grid input of grids No.1 and No.2 tied together, 0.35 *max* watt. This is a DISCONTINUED type listed for reference only.

89

**DETECTOR AMPLIFIER TRIODE**

**V99**

Glass types used as detector or amplifier in battery-operated receivers. Filament volts (dc), 3.0 to 3.3; amperes, 0.060 to 0.063. Characteristics as class A<sub>1</sub> amplifier: plate volts, 90 *max*; grid volts, -4.5; amplification factor, 6.6; transconductance, 425  $\mu$ mhos; plate ma., 2.5. Operation as grid-resistor detector: plate volts, 45; grid resistor, 0.25 to 5 megohms; grid capacitor, 250  $\mu$ mf; grid return to (+) filament. Operation as biased detector: plate volts, 90 *max*; grid volts (approx.), -10.5. These are DISCONTINUED types listed for reference only.

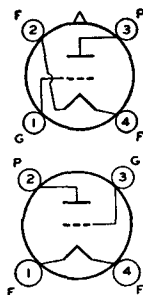

**X99**

**DETECTOR AMPLIFIER TRIODE**

Glass type used as detector or amplifier in battery-operated receivers. Outline 42, OUTLINES SECTION. Filament volts (dc), 5.0; amperes, 0.25. Operation as class A<sub>1</sub> amplifier: plate volts, 180 *max*; grid volts, -13.5; amplification factor, 8.5; transconductance, 1800  $\mu$ mhos; plate ma., 7.7; load resistance, 10650 ohms; output watts, 0.285. Operation as biased detector: plate volts, 180; grid volts, -21. This is a DISCONTINUED type listed for reference only.

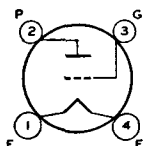

**112-A**

**RECTIFIER—BEAM POWER TUBE**

Glass octal type used as combined half-wave rectifier and output amplifier in ac/dc receivers. Outline 27, OUTLINES SECTION. Tube requires octal socket. Heater volts (ac/dc), 117; amperes, 0.09. For ratings and operation of rectifier unit, refer to type 117N7-GT. Type 117L7/M7-GT is used principally for renewal purposes.

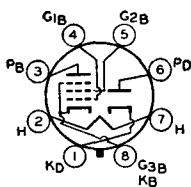

**117L7/  
M7-GT**

**AMPLIFIER UNIT AS CLASS A<sub>1</sub> AMPLIFIER**

**Maximum Ratings:**

PLATE VOLTAGE.....	117 <i>max</i>	volts
GRID-NO.2 (SCREEN-GRID) VOLTAGE.....	117 <i>max</i>	volts
PLATE INPUT.....	6.0 <i>max</i>	watts
GRID-NO.2 DISSIPATION.....	1.0 <i>max</i>	watt

**Typical Operation:**

Plate Voltage.....	105	volts
Grid-No.2 Voltage.....	105	volts
Grid-No.1 (Control-Grid) Voltage.....	-5.2	volts
Peak AF Grid-No.1 Voltage.....	5.2	volts
Zero-Signal Plate Current.....	43	ma
Maximum-Signal Plate Current.....	43	ma
Zero-Signal Grid-No.2 Current (Approx.).....	4	ma
Maximum-Signal Grid-No.2 Current (Approx.).....	5.5	ma
Plate Resistance (Approx.).....	17000	ohms
Transconductance.....	5300	$\mu$ mhos
Load Resistance.....	4000	ohms
Total Harmonic Distortion.....	5	per cent
Maximum-Signal Power Output.....	0.85	watt

**RECTIFIER—BEAM POWER TUBE**

Glass octal type used as combined half-wave rectifier and output amplifier in ac/dc receivers. Outline 27, OUTLINES SECTION. Tube requires octal socket and may be mounted in any position. Heater volts (ac/dc), 117; amperes, 0.09. This type is used principally for renewal purposes.

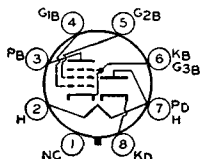

**117N7-GT**

# RCA Receiving Tube Manual

## RECTIFIER UNIT AS HALF-WAVE RECTIFIER

### Maximum Ratings:

PEAK INVERSE PLATE VOLTAGE.....	350 max	volts
PEAK PLATE CURRENT.....	450 max	ma
DC OUTPUT CURRENT.....	75 max	ma
PEAK HEATER-CATHODE VOLTAGE:		
Heater negative with respect to cathode.....	175 max	volts

### Typical Operation (Capacitor-Input Filter):

AC Plate-Supply Voltage (rms).....	117	volts
Filter-Input Capacitor.....	40	$\mu$ f
Minimum Total Effective Plate-Supply Impedance $\dagger$ .....	15	ohms
DC Output Current.....	75	ma
DC Output Voltage at Input to Filter (Approx.).....	122	volts

$\dagger$ When a filter-input capacitor larger than 40  $\mu$ f is used, it may be necessary to use more plate-supply impedance than the minimum value shown to limit the peak plate current to the rated value.

## AMPLIFIER UNIT AS CLASS A<sub>1</sub> AMPLIFIER

### Maximum Ratings:

PLATE VOLTAGE.....	117 max	volts
GRID-NO.2 (SCREEN-GRID) VOLTAGE.....	117 max	volts
PLATE DISSIPATION.....	5.5 max	watts
GRID-NO.2 INPUT.....	1.0 max	watts

### Typical Operation:

Plate Voltage.....	100	volts
Grid-No.2 Voltage.....	100	volts
Grid-No.1 (Control-Grid) Voltage.....	-6	volts
Peak AF Grid-No.1 Voltage.....	6	volts
Zero-Signal Plate Current.....	51	ma
Zero-Signal Grid-No.2 Current.....	5	ma
Plate Resistance (Approx.).....	16000	ohms
Transconductance.....	7000	$\mu$ mhos
Load Resistance.....	3000	ohms
Total Harmonic Distortion.....	6	per cent
Maximum-Signal Power Output.....	1.2	watts

### Maximum Circuit Values (For maximum rated conditions):

Grid-No.1-Circuit Resistance:		
For fixed-bias operation.....	0.25 max	megohm
For cathode-bias operation.....	1.0 max	megohm

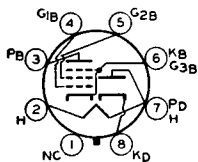

### RECTIFIER—BEAM POWER TUBE

Glass octal type used as combined half-wave rectifier and output tube. Outline 27, OUTLINES SECTION. Tube requires octal socket. Heater volts (ac/dc), 117; amperes, 0.09. This type is electrically identical with glass-octal type 117L7/M7-GT. Type 117P7-GT is used principally for renewal purposes.

# 117P7-GT

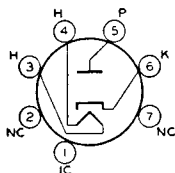

### HALF-WAVE VACUUM RECTIFIER

Miniature type used in power supply of ac/dc/battery radio receivers. The heater is designed for operation directly across a 117-volt ac or dc supply line.

# 117Z3

HEATER VOLTAGE (AC/DC).....	117	volts
HEATER CURRENT.....	0.04	ampere

## HALF-WAVE RECTIFIER

### Maximum Ratings:

PEAK INVERSE PLATE VOLTAGE .....	330 max	volts
PEAK PLATE CURRENT .....	540 max	ma
DC OUTPUT CURRENT .....	90 max	ma
PEAK HEATER-CATHODE VOLTAGE:		
Heater negative with respect to cathode .....	175 max	volts
Heater positive with respect to cathode .....	100 ma	volts

### Typical Operation (Capacitor-Input to Filter):

AC Plate-Supply Voltage (rms) .....	117	volts
Filter-Input Capacitor .....	30	$\mu$ f
Minimum Total Effective Plate-Supply Impedance† .....	20	ohms
DC Output Current .....	90	ma
DC Output Voltage at Input to Filter (Approx):		
At half-load current (45 ma.) .....	130	volts
At full-load current (90 ma.) .....	110	volts
Voltage Regulation (Approx.):		
Half-load to full-load current .....	20	volts

† When a filter-input capacitor larger than 40  $\mu$ f is used, it may be necessary to use more plate-supply impedance than the minimum value shown to limit the peak plate current to the rated value.

## INSTALLATION AND APPLICATION

Type 117Z3 requires miniature seven-contact socket and may be mounted in any position. Outline 13, OUTLINES SECTION. It is especially important that this tube, like other power-handling tubes, should be adequately ventilated.

Refer to the CIRCUITS SECTION for typical application of the 117Z3 as a half-wave rectifier in a portable 3-way superheterodyne receiver.

### OPERATION CHARACTERISTICS

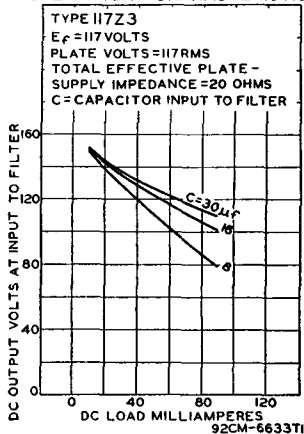

## HALF-WAVE VACUUM RECTIFIER

Glass octal type used in power supply of ac/dc/battery radio receivers. Dimensions: maximum over-all length, 3 inches; maximum seated height, 2 3/4 inches; maximum diameter, 1-5/16 inches; T-9 bulb; intermediate-shell octal 7-pin base. This type may be supplied with pin No.1 omitted. Tube requires octal socket. Heater volts (ac/dc), 117; amperes, 0.04. Maximum ratings as half-wave rectifier: peak inverse

### 117Z4-GT

plate volts, 350 max; peak plate ma., 540 max; peak heater-cathode volts, 175 max. Typical operation with capacitor-input filter: ac plate supply volts (rms), 117; minimum total effective plate-supply impedance, 30 ohms; dc output ma., 90. This is a DISCONTINUED type listed for reference only.

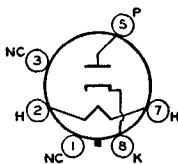

## VACUUM RECTIFIER-DOUBLER

Glass octal type used as half-wave rectifier or voltage doubler in ac/dc receivers. Outline 23, OUTLINES SECTION. Tube requires octal socket and may be mounted in any position. This type may be supplied with pin No.1 omitted. Heater volts (ac/dc), 117; amperes, 0.075. This type is used principally for renewal purposes.

### 117Z6-GT

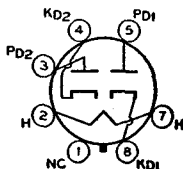



## HALF-WAVE RECTIFIER

### Maximum Ratings:

PEAK INVERSE PLATE VOLTAGE.....			700 <i>max</i>	volts
PEAK PLATE CURRENT (Per Plate).....			360 <i>max</i>	ma
DC OUTPUT CURRENT (Per Plate).....			60 <i>max</i>	ma
PEAK HEATER-CATHODE VOLTAGE.....			350 <i>max</i>	volts

### Typical Operation (Capacitor-Input Filter):<sup>o</sup>

AC Plate-Supply Voltage per Plate (rms)....	117	150	235	volts
Filter-Input Capacitor.....	40	40	40	$\mu$ f
Minimum Total Effective Plate-Supply Impedance per Plate†.....	15	40	100	ohms
DC Output Current per Plate.....	60	60	60	ma

## VOLTAGE DOUBLER

### Maximum Ratings:

(Same as for Half-Wave Rectifier)

### Typical Operation:

	<i>Half-Wave</i>	<i>Full-Wave</i>	
AC Plate-Supply Voltage per Plate (rms).....	117	117	volts
Filter-Input Capacitor.....	40	40	$\mu$ f
Minimum Total Effective Plate-Supply Impedance per Plate†..	30	15	ohms
DC Output Current.....	60	60	ma

<sup>o</sup> In half-wave rectifier service, the two units may be used separately or in parallel.

† When a filter-input capacitor larger than 40 $\mu$ f is used, it may be necessary to use more plate-supply impedance than the minimum value shown to limit the peak plate current to the rated value.

## POWER TRIODE

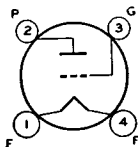

Glass type used in output stage of radio receivers. Outline 42, OUTLINES SECTION. Filament volts (ac/dc), 5.0; amperes, 1.25. Characteristics: plate volts, 250; grid volts, -60; plate ma., 30; amplification factor, 3; plate resistance, 1750 ohms; transconductance, 1700  $\mu$ mhos; load resistance, 5000 ohms; output watts, 1.8. This is a DISCONTINUED type listed for reference only.

183/483

## DETECTOR AMPLIFIER TRIODE

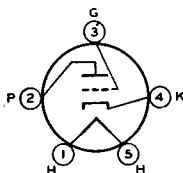

Glass type used as detector or class A<sub>1</sub> amplifier in radio receivers. Outline 35, OUTLINES SECTION. Heater volts (ac/dc), 3; amperes, 1.25. Characteristics: plate volts, 180; grid volts, -9; amplification factor, 12.5; plate resistance, 8900 ohms; transconductance, 1400  $\mu$ mhos; plate ma., 5.8. This is a DISCONTINUED type listed for reference only.

485

## CURRENT REGULATORS

Constant-current regulating devices (ballast tubes) used in radio receivers. Bases fit the standard mogul screw socket and tubes may be mounted in any position. Tubes operate at high bulb temperature. They must be surrounded by a protective metal ventilating stack. Operating conditions: voltage range, 40 to 60 volts; ambient temperature, 150°F; operating current for the 876, 1.7 amperes; for the 886, 2.05 amperes. These are DISCONTINUED types listed for reference only.

876

886



# RCA Picture Tube

Type	Envelope	Aluminized Screen Asterisk (*) denotes "Silvermax" type	Faceplate $\phi$	External Conductive Coating		Focusing Method	Deflection Method	Approx. Horizontal Deflection Angle Degrees	Maximum Dimensions Inches			
				Max. $\mu\text{ft}$	Min. $\mu\text{ft}$				Overall Length	Envelope Dia. or Diagonal	Width	Height
<b>Black-and-White Types</b>												
5TP4	Ⓒ	Yes	CL	500	100	E	M	50	12 $\frac{1}{8}$	5 $\frac{1}{8}$	—	—
7DP4	Ⓒ	No	CL	1500	400	E	M	50	14 $\frac{7}{16}$	7 $\frac{3}{16}$	—	—
7JP4	Ⓒ	No	CL	None	None	E	E $\odot$	—	14 $\frac{7}{8}$	7 $\frac{1}{8}$	—	—
8DP4	Ⓔ	No	FG	350	250	E	M	85	10 $\frac{3}{4}$	8 $\frac{1}{2}$	7 $\frac{15}{16}$	6 $\frac{1}{8}$
9AP4	Ⓒ	No	CL	None	None	E	M	40	21 $\frac{3}{8}$	9 $\frac{1}{8}$	—	—
10BP4	Ⓒ	No	Same as 10BP4-A, except has clear glass faceplate.									
10BP4-A	Ⓒ	No	FG	2500	500	M	M	52	18	10 $\frac{5}{8}$	—	—
10FP4-A	Ⓒ	*Yes	FG	2500	500	M	M	50	18	10 $\frac{5}{8}$	—	—
12AP4	Ⓒ	No	CL	None	None	E	M	40	25 $\frac{3}{8}$	12 $\frac{3}{16}$	—	—
12KP4-A	Ⓒ	*Yes	FG	2500	500	M	M	54	18	12 $\frac{3}{16}$	—	—
12LP4	Ⓒ	No	Same as 12LP4-A, except has clear glass faceplate.									
12LP4-A	Ⓒ	No	FG	2000	750	M	M	57	19 $\frac{1}{8}$	12 $\frac{3}{16}$	—	—
14EP4/ 14CP4	Ⓔ	No	FG	2000	750	M	M	65	16 $\frac{7}{8}$	13 $\frac{15}{16}$	12 $\frac{1}{2}$	9 $\frac{7}{16}$
14HP4	Ⓔ	No	FG	2000	750	E	M	65	17 $\frac{3}{16}$	13 $\frac{15}{16}$	12 $\frac{1}{2}$	9 $\frac{7}{16}$
14RP4	Ⓔ	No	FG	1200	800	E	M	85	14 $\frac{1}{2}$	14 $\frac{1}{8}$	13 $\frac{3}{16}$	10 $\frac{1}{16}$
14RP4-A	Ⓔ	*Yes	Same as 14RP4, except has aluminized screen.									
16AP4	Ⓜ	No	Same as 16AP4-A, except has clear glass faceplate.									
16AP4-A	Ⓜ	No	FG	None	None	M	M	53	22 $\frac{3}{16}$	16	—	—
16DP4-A	Ⓒ	No	FG	None	None	M	M	60	21	16	—	—
16GP4	Ⓜ	No	Same as 16GP4-B, except has Filterglass faceplate.									
16GP4-A	Ⓜ	No	Same as 16GP4-B, except has clear glass faceplate.									
16GP4-B	Ⓜ	No	FFG	None	None	M	M	70	17 $\frac{11}{16}$	16	—	—
16GP4-C	Ⓜ	No	Same as 16GP4-B, except has frosted clear glass faceplate.									
16LP4-A	Ⓒ	No	FG	2000	750	M	M	52	22 $\frac{3}{8}$	16	—	—
16RP4/ 16KP4	Ⓔ	No	FG	1500	750	M	M	65	19 $\frac{1}{8}$	16 $\frac{1}{4}$	14 $\frac{7}{8}$	11 $\frac{3}{8}$
16RP4-A/ 16KP4-A	Ⓔ	*Yes	Same as 16RP4/16KP4, except has aluminized screen.									
16TP4	Ⓔ	No	FG	2000	750	M	M	65	18 $\frac{1}{2}$	16 $\frac{3}{16}$	14 $\frac{15}{16}$	11 $\frac{1}{16}$
16WP4-A	Ⓒ	No	FG	1500	750	M	M	70	18 $\frac{1}{8}$	16	—	—
17AVP4/ 17ATP4	Ⓔ	No	FG	1500	1200	E	M	85	16	16 $\frac{3}{4}$	15 $\frac{3}{16}$	12 $\frac{13}{16}$
17AVP4-A/ 17ATP4-A	Ⓔ	*Yes	Same as 17AVP4/17ATP4 except has aluminized screen.									
17BP4-A	Ⓔ	No	FG	1500	750	M	M	65	19 $\frac{3}{16}$	16 $\frac{3}{4}$	15 $\frac{3}{16}$	12 $\frac{13}{16}$
17BP4-B	Ⓔ	*Yes	Same as 17BP4-A, except has aluminized screen.									
17CP4	Ⓜ	No	FFG	None	None	M	M	66	19	17	16 $\frac{1}{16}$	12 $\frac{3}{8}$
17CP4-A	Ⓜ	No	Same as 17CP4, except has Filterglass faceplate.									
17GP4	Ⓜ	No	FFG	None	None	E	M	66	19 $\frac{3}{16}$	17	16 $\frac{1}{16}$	12 $\frac{3}{8}$
17HP4/ 17RP4	Ⓔ	No	FG	1500	750	E	M	65	19 $\frac{3}{16}$	16 $\frac{3}{4}$	15 $\frac{3}{16}$	12 $\frac{13}{16}$
17HP4-B	Ⓔ	*Yes	FG	1500	750	E	M	65	19 $\frac{3}{16}$	16 $\frac{3}{4}$	15 $\frac{3}{16}$	12 $\frac{13}{16}$
17JP4	Ⓔ	No	FG	750	500	M	M	65	19 $\frac{3}{16}$	16 $\frac{3}{4}$	15 $\frac{3}{16}$	12 $\frac{13}{16}$

For notes and basing diagrams, see pages 300 and 301.

# Characteristics Chart

Neck Length Inches	Minimum Screen Size Inches	High Voltage Terminal	Base	Maximum Final High-Voltage Electrode (Ultra*) Volts	Typical Operating Conditions in Grid-Drive Service				P M Ion-Trap Magnet Min. Gausses	 Type
					Final High-Voltage Electrode (Ultra*) Volts	Grid-No. 2 Volts	Focusing Electrode Volts	Grid-No. 1 Volts For Wound Electrode of Focused Raster		
<b>Black-and-White Types</b>										
7½	4½ Dia.	Cavity Cap	B	27000	27000	200	4320 to 5400	-37 to -93	None	<b>5TP4-A</b>
8½	6 Dia.	Cavity Cap	B	8000	6000	250	1215 to 1645	-22 to -58	—	<b>7DP4</b>
—	6 Dia.	Base Pin	C	6000	6000	∞	1620 to 2400	-67 to -163	None	<b>7JP4</b>
6½	7¾ x 5¾	Cavity Cap	J	8000	6000 8000	150 200	+15 to +315 +60 to +360	-13 to -35 -17 to -46	31 36	<b>8DP4</b>
10	7¾ Dia.	Medium Cap	D	7000	7000	250	1190 to 1790	-15 to -55	None	9AP4
Ratings are typical operating conditions are same as for type 10BP4-A.										10BP4
8¾	9¾ Dia.	Cavity Cap	E	12000	8000 to 12000	250	—	-22 to -58	—	<b>10BP4-A</b>
8¾	9¾ Dia.	Cavity Cap	E	12000	8000 to 12000	250	—	-22 to -58	None	<b>10FP4-A</b>
9¾	10¾ Dia.	Medium Cap	D	7000	7000	250	1190 to 1790	-15 to -55	None	12AP4
7½	11½ Dia.	Cavity Cap	E	12000	9000 to 12000	250	—	-22 to -58	None	<b>12KP4-A</b>
Ratings and typical operating conditions are same as for type 12LP4-A.										12LP4
8¾	11 Dia.	Cavity Cap	E	12000	9000 to 12000	250	—	-22 to -58	—	<b>12LP4-A</b>
7¾	11½ x 8¾	Cavity Cap	E	14000	12000 14000	300 300	—	-28 to -72	29 31	<b>14EP4/ 14CP4</b>
7½	11½ x 8¾	Cavity Cap	H	14000	12000 14000	300 300	-50 to +265 -55 to +310	-28 to -72	29 31	<b>14HP4</b>
6½	12½ x 9½	Cavity Cap	H	14000	10000 14000	300 300	-50 to +350 +70 to +470	-26 to -70	34 41	<b>14RP4</b>
Ratings and typical operating conditions are same as for type 14RP4										<b>14RP4-A</b>
Ratings and typical operating conditions are same as for type 16AP4-A.										16AP4
7¾	14¾ Dia.	Metal-Shell Lip	F	14000	9000 12000	300 300	—	-28 to -72	25 29	<b>16AP4-A</b>
7¾	14¾ Dia.	Cavity Cap	F	15000	9000 to 15000	250	—	-22 to -58	—	<b>16DP4-A</b>
Ratings and typical operating conditions are same as for type 16GP4-B.										16GP4
Ratings and typical operating conditions are same as for type 16GP4-B.										16GP4-A
6¾	14¾ Dia.	Metal-Shell Lip	F	14000	12000 14000	300 300	—	-28 to -72	29 31	<b>16GP4-B</b>
Ratings and typical operating conditions are same as for type 16GP4-B.										16GP4-C
7¾	14½ Dia.	Cavity Cap	E	14000	12000 to 14000	300	—	-28 to -72	—	<b>16LP4-A</b>
7½	13½ x 10½	Cavity Cap	A	16000	12000 14000	300 300	—	-28 to -72	29 31	<b>16RP4/ 16KP4</b>
Ratings and typical operating conditions are same as for type 16RP4/16KP4.										<b>16RP4-A/ 16KP4-A</b>
6¾	13½ x 10½	Cavity Cap	E	14000	12000 14000	300 300	—	-28 to -72	29 31	<b>16TP4</b>
7¾	14½ Dia.	Cavity Cap	E	16000	12000 to 16000	250	—	-22 to -58	—	<b>16WP4-A</b>
6½	14¾ x 11¾	Cavity Cap	H	16000	14000 16000	300 300	-55 to +310 -65 to +350	-28 to -72	31 33	<b>17AVP4/ 17ATP4</b>
Ratings and typical operating conditions are same as for type 17AVP4/17ATP4.										<b>17AVP4-A/ 17ATP4-A</b>
7½	14¾ x 11¾	Cavity Cap	A	16000	12000 14000	300 300	—	-28 to -72	29 31	<b>17BP4-A</b>
Ratings and typical operating conditions are same as for type 17BP4-A.										<b>17BP4-B</b>
7¾	14¾ x 11¾	Metal-Shell Lip	F	16000	12000 14000	300 300	—	-28 to -72	29 31	<b>17CP4</b>
Ratings and typical operating conditions are same as for type 17CP4										17CP4-A
7½	14¾ x 10½	Metal-Shell Lip	G	16000	12000 14000	300 300	2040 to 2760 2380 to 3220	-28 to -72	29 31	<b>17GP4</b>
7¾	14¾ x 11¾	Cavity Cap	H	16000	14000 16000	300 300	-55 to +300 -65 to +350	-28 to -72	31 33	<b>17HP4/ 17RP4</b>
8½	14¾ x 11¾	Cavity Cap	H	16000	14000 16000	300 300	-55 to +300 -65 to +350	-28 to -72	31 33	<b>17HP4-B</b>
7½	14¾ x 10¾	Cavity Cap	A	18000	14000 16000	300 300	—	-28 to -72	31 33	<b>17JP4</b>

# RCA Picture Tube

(continued from

Type	Envelope	Aluminized Screen Asterisk (*) denotes "Silvermax" type	Faceplate $\phi$	External Conductive Coating		Focusing Method	Deflection Method	Approx. Horizontal Deflection Angle Degrees	Maximum Dimensions Inches			
				Max. $\mu$ l	Min. $\mu$ l				Overall Length	Envelope Dia. or Diagonal	Width	Height
<b>Black-and-White Types (Cont'd)</b>												
17LP4/ 17VP4	G	No	FG**	1500	750	E	M	65	19 $\frac{9}{16}$	16 $\frac{3}{4}$	15 $\frac{33}{64}$	12 $\frac{13}{32}$
17LP4-A	G	*Yes	FG**	1500	750	E	M	65	19 $\frac{9}{16}$	16 $\frac{3}{4}$	15 $\frac{33}{64}$	12 $\frac{13}{32}$
17QP4	G	No	FG**	1500	750	M	M	65	19 $\frac{9}{16}$	16 $\frac{3}{4}$	15 $\frac{33}{64}$	12 $\frac{13}{32}$
17QP4-A	G	*Yes	FG**	1500	750	M	M	65	19 $\frac{9}{16}$	16 $\frac{3}{4}$	15 $\frac{33}{64}$	12 $\frac{13}{32}$
17TP4	M	No	FFG	None	None	E	M	66	19 $\frac{9}{16}$	17	16 $\frac{1}{16}$	12 $\frac{3}{8}$
19AP4	M	No	Same as 19AP4-B, except has clear glass faceplate.									
19AP4-A	M	No	Same as 19AP4-B, except has Filterglass faceplate.									
19AP4-B	M	No	FFG	None	None	M	M	66	22	18 $\frac{3}{4}$	—	—
19AP4-D	M	No	Same as 19AP4-B, except has frosted clear glass faceplate.									
20CP4	G	No	FG	None	None	M	M	66	21 $\frac{13}{16}$	20 $\frac{9}{32}$	18 $\frac{7}{8}$	15 $\frac{1}{8}$
20DP4-A/ 20CP4-A	G	No	FG	750	500	M	M	66	21 $\frac{7}{8}$	20 $\frac{7}{32}$	18 $\frac{13}{16}$	15 $\frac{1}{16}$
20DP4-C/ 20CP4-D	G	*Yes	FG	750	500	M	M	66	21 $\frac{7}{8}$	20 $\frac{7}{32}$	18 $\frac{13}{16}$	15 $\frac{1}{16}$
20HP4-A/ 20MP4	G	No	FG	1500	750	E	M	66	22 $\frac{1}{8}$	20 $\frac{7}{32}$	18 $\frac{13}{16}$	15 $\frac{1}{16}$
20HP4-D	G	*Yes	FG	1500	750	E	M	66	22 $\frac{1}{8}$	20 $\frac{7}{32}$	18 $\frac{13}{16}$	15 $\frac{1}{16}$
21ACP4-A	G	*Yes	FG	2500	2000	M	M	85	20 $\frac{3}{8}$	21 $\frac{1}{2}$	20 $\frac{3}{8}$	16 $\frac{1}{2}$
21ALP4-A	G	*Yes	FG	1500	1000	E	M	85	20 $\frac{3}{8}$	21 $\frac{1}{2}$	20 $\frac{3}{8}$	16 $\frac{1}{2}$
21ALP4-B	G	*Yes	FG	1500	1000	E	M	85	20 $\frac{3}{8}$	21 $\frac{1}{2}$	20 $\frac{3}{8}$	16 $\frac{1}{2}$
21AMP4-A	G	*Yes	FG	2500	2000	M	M	85	20 $\frac{3}{8}$	21 $\frac{1}{2}$	20 $\frac{3}{8}$	16 $\frac{1}{2}$
21AP4	M	No	FFG	None	None	M	M	66	22 $\frac{5}{8}$	21	19 $\frac{27}{32}$	15 $\frac{1}{16}$
21ATP4	G	*Yes	FG	1500	1000	E	M	85	20 $\frac{3}{8}$	21 $\frac{1}{2}$	20 $\frac{3}{8}$	16 $\frac{1}{2}$
21ATP4-A	G	*Yes	Same as 21ALP4-B.									
21AVP4/ 21AUP4	G	No	FG	2500	2000	E	M	67	23 $\frac{13}{32}$	21 $\frac{1}{2}$	20 $\frac{3}{8}$	16 $\frac{1}{2}$
21AVP4-A/ 21AUP4-A	G	*Yes	Same as 21AVP4/21AUP4, except has aluminized screen.									
21AWP4	G	*Yes	FG	1500	1200	M	M	67	23 $\frac{13}{32}$	21 $\frac{1}{2}$	20 $\frac{3}{8}$	16 $\frac{1}{2}$
21CEP4	G	*Yes	FG	2500	2000	E	M	106	14 $\frac{3}{4}$	21 $\frac{1}{2}$	20 $\frac{3}{8}$	16 $\frac{1}{2}$
21EP4	G	No	Same as 21EP4-A, except has no external conductive coating.									
21EP4-A	G	No	FG**	750	500	M	M	65	23 $\frac{3}{8}$	21 $\frac{11}{32}$	20 $\frac{3}{8}$	15 $\frac{11}{16}$
21EP4-B	G	*Yes	Same as 21EP4-A, except has aluminized screen.									
21FP4-A	G	No	FG**	750	500	E	M	65	23 $\frac{3}{8}$	21 $\frac{11}{32}$	20 $\frac{3}{8}$	15 $\frac{11}{16}$
21FP4-C	G	*Yes	Same as 21FP4-A, except has aluminized screen.									
21MP4	M	No	FFG	None	None	E	M	66	22 $\frac{5}{8}$	21	19 $\frac{27}{32}$	15 $\frac{1}{16}$

For notes and basing diagrams, see pages 300 and 301.

# Characteristics Chart

pages 296 and 297)

Nose Length inches	Minimum Screen Size inches	High Voltage Terminal	Boring	Maximum Final High-Voltage Electrode (Ultram) Volts	Typical Operating Conditions in Grid-Drive Service				P M Ion-Trap Magnet Min. Gauss	 Type
					Final High-Voltage Electrode (Ultram) Volts	Grid-No. 2 Volts	Focusing Electrode Volts	Grid-No. 1 Volts For Visual Extinction of Focused Raster		
<b>Black-and-White Types (Cont'd)</b>										
7½	14¼ x 10¾	Cavity Cap	H	16000	14000 16000	300 300	-55 to +300 -65 to +350	-28 to -72 -28 to -72	31 33	<b>17LP4/ 17VP4</b>
7½	14¼ x 10¾	Cavity Cap	H	16000	14000 16000	300 300	-55 to +300 -65 to +350	-28 to -72 -28 to -72	31 33	<b>17LP4-A</b>
7½	14¼ x 10¾	Cavity Cap	A	16000	12000 14000	300 300	— —	-28 to -72 -28 to -72	29 31	<b>17QP4</b>
7½	14¼ x 10¾	Cavity Cap	A	18000	12000 14000	300 300	— —	-28 to -72 -28 to -72	29 31	<b>17QP4-A</b>
7½	14¾ x 10½	Metal-Shell Lip	G	16000	14000 16000	300 300	-55 to +300 -65 to +350	-28 to -72 -28 to -72	31 33	<b>17TP4</b>
Ratings and typical operating conditions are same as for type 19AP4-B.										19AP4
Ratings and typical operating conditions are same as for type 19AP4-B.										19AP4-A
7½	17¼ Dia.	Metal-Shell Lip	F	16000	12000 14000	300 300	— —	-28 to -72 -28 to -72	29 31	<b>19AP4-B</b>
Ratings and typical operating conditions are same as for type 19AP4-B										19AP4-D
7½	17 x 12¾	Cavity Cap	F	18000	14000 16000	300 300	— —	-28 to -72 -28 to -72	31 33	<b>20CP4</b>
7½	17 x 12¾	Cavity Cap	A	18000	14000 16000	300 300	— —	-28 to -72 -28 to -72	31 33	<b>20DP4-A/ 20CP4-A</b>
7½	17 x 12¾	Cavity Cap	A	18000	14000 16000	300 300	— —	-28 to -72 -28 to -72	31 33	<b>20DP4-C/ 20CP4-D</b>
7½	17 x 12¾	Cavity Cap	H	16000	14000 16000	300 300	-55 to +300 -65 to +350	-28 to -72 -28 to -72	31 33	<b>20HP4-A/ 20MP4</b>
7½	17 x 12¾	Cavity Cap	H	16000	14000 16000	300 300	-55 to +300 -65 to +350	-28 to -72 -28 to -72	31 33	<b>20HP4-D</b>
7½	19½ x 15½	Cavity Cap	A	20000	16000 18000	300 400	— —	-28 to -72 -37 to -96	33 35	<b>21ACP4-A</b>
7½	19½ x 15½	Cavity Cap	H	18000	16000 18000	300 400	-65 to +350 -75 to +400	-28 to -72 -37 to -96	33 35	<b>21ALP4-A</b>
7½	19½ x 15½	Cavity Cap	H	20000	16000 18000	300 400	-65 to +350 -75 to +400	-28 to -72 -37 to -96	33 35	<b>21ALP4-B</b>
7½	19½ x 15½	Cavity Cap	A	18000	16000 18000	300 400	— —	-28 to -72 -37 to -96	33 35	<b>21AMP4-A</b>
7½	18½ x 13½	Metal-Shell Lip	F	18000	14000 16000	300 300	— —	-28 to -72 -28 to -72	31 33	<b>21AP4</b>
7½	19½ x 15½	Ratings and typical operating conditions are same as for type 21ALP4-A								<b>21ATP4</b>
Ratings and typical operating conditions are same as for type 21ALP4-B										<b>21ATP4-A</b>
7½	19½ x 15½	Cavity Cap	H	18000	16000 18000	300 400	-65 to +350 -75 to +400	-28 to -72 -37 to -96	33 35	<b>21AVP4/ 21AUP4</b>
Ratings and typical operating conditions are same as for type 21AVP4/21AUP4.										<b>21AVP4-A/ 21AUP4-A</b>
7½	19½ x 15½	Cavity Cap	A	18000	16000 18000	300 400	— —	-28 to -72 -37 to -96	33 35	<b>21AWP4</b>
5½	19½ x 15½	Cavity Cap	K	18000	14000 16000	300 400	0 to +400 0 to +400	-28 to -72 -36 to -94	None	<b>21CEP4</b>
Ratings and typical operating conditions are same as for type 21EP4-A										<b>21EP4</b>
7½	19½ x 13¾	Cavity Cap	A	18000	14000 16000	300 300	— —	-28 to -72 -28 to -72	31 33	<b>21EP4-A</b>
Ratings and typical operating conditions are same as for type 21EP4-A										<b>21EP4-B</b>
7½	19½ x 13¾	Cavity Cap	H	18000	14000 16000	300 300	-55 to +300 -65 to +350	-28 to -72 -28 to -72	31 33	<b>21FP4-A</b>
Ratings and typical operating conditions are same as for type 21FP4-A										<b>21FP4-C</b>
7½	18½ x 13½	Metal-Shell Lip	G	16000	14000 16000	300 300	-55 to +300 -65 to +350	-28 to -72 -28 to -72	31 33	<b>21MP4</b>

# RCA Picture Tube

(continued from

RCA Type	Envelope	Aluminized Screen Asterisk (*) denotes "Silverama" type	Faceplate $\phi$	External Conductive Coating		Focusing Method	Deflection Method	Approx. Horizontal Deflection Angle Degrees	Maximum Dimensions Inches			
				Max. $\mu\text{in.}$	Min. $\mu\text{in.}$				Overall Length	Envelope Dia. w/ Diagonal	Width	Height
<b>Black-and-White Types (Cont'd)</b>												
21YP4	G	No	FG	750	500	E	M	65	23 $\frac{13}{32}$	21 $\frac{11}{32}$	20 $\frac{3}{8}$	15 $\frac{11}{16}$
21YP4-A	G	* Yes	Same as 21YP4, except has aluminized screen.									
21ZP4-A	G	No	FG	750	500	M	M	65	23 $\frac{13}{32}$	21 $\frac{11}{32}$	20 $\frac{3}{8}$	15 $\frac{11}{16}$
21ZP4-B	G	* Yes	Same as 21ZP4-A, except has aluminized screen.									
24CP4-A	G	* Yes	FG	2500	2000	M	M	85	21 $\frac{1}{2}$	24 $\frac{1}{8}$	22 $\frac{13}{16}$	18 $\frac{9}{16}$
24DP4-A	G	* Yes	FG	2500	2000	E	M	85	21 $\frac{1}{2}$	24 $\frac{1}{8}$	22 $\frac{13}{16}$	18 $\frac{9}{16}$
24VP4-A	G	* Yes	FG	2500	2000	M	M	85	21 $\frac{1}{2}$	24 $\frac{1}{8}$	22 $\frac{13}{16}$	18 $\frac{9}{16}$
24YP4	G	* Yes	FG	2500	2000	E	M	85	21 $\frac{1}{2}$	24 $\frac{1}{8}$	22 $\frac{13}{16}$	18 $\frac{9}{16}$
27MP4	M	* Yes	FFG	None	None	M	M	85	22 $\frac{3}{16}$	27 $\frac{1}{8}$	25 $\frac{1}{16}$	20 $\frac{1}{8}$
<b>Color Types</b>												
15GP22**	G	Yes	CL	3000	1500	E	M	45	26 $\frac{1}{8}$	14 $\frac{23}{32}$ *	—	—
21AXP22	M	Yes	FG	None	None	E	M	70	25 $\frac{3}{16}$	20 $\frac{13}{16}$ †	—	—
21AXP22-A	M	Yes	FG	None	None	E	M	70	25 $\frac{3}{16}$	20 $\frac{13}{16}$ †	—	—

## NOTES

Light face=Discontinued type.

G=Glass rectangular.

⊕=Glass round.

M=Metal rectangular.

⊙=Metal round.

CL=Clear glass.

FG=Filterglass.

FFG=Frosted Filterglass.

\*\*"Silverama" type.

M=Magnetic.

E=Electrostatic.

■=Projection type.

○=Spherical, unless otherwise specified.

▲▲=Cylindrical faceplate.

†At ultron lip-terminal.

★At faceplate.

●●This type has a flat, aluminized, Filterglass, phosphor-dot, screen plate.

## BASING DIAGRAMS

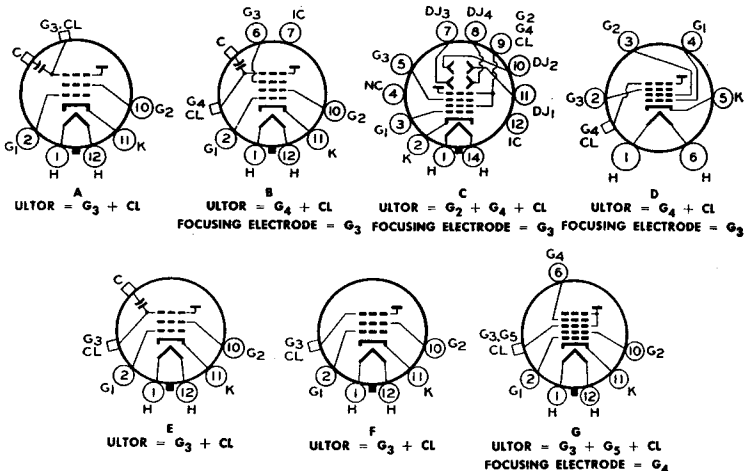

# Characteristics Chart

pages 298 and 299)

Neck Length inches	Minimum Screen Size inches	High Voltage Terminal	Bas-ing	Maximum Final High-Voltage Electrode (Ultor <sup>®</sup> ) Volts	Typical Operating Conditions in Grid-Drive Service				P M Ion-Trap Magnet Mill. Gausses	RCA Type	
					Final High-Voltage Electrode (Ultor <sup>®</sup> ) Volts	Grid-No. 2 Volts	Focusing Electrode Volts	Grid-No. 1 Volts For Visual Extension of Focused Beamer			
<b>Black-and-White Types (Cont'd)</b>											
7½	19½ x 14½	Cavity Cap	H	18000	16000 18000	300 300	-65 to +350 -70 to +395	-28 to -72 -28 to -72	33 35	<b>21YP4</b>	
Ratings and typical operating conditions are same as for type 21YP4.										<b>21YP4-A</b>	
7½	19½ x 14½	Cavity Cap	A	18000	16000 18000	300 300	—	-28 to -72 -28 to -72	33 35	<b>21ZP4-A</b>	
Ratings and typical operating conditions are same as for type 21ZP4-A.										<b>21ZP4-B</b>	
7½	21½ x 16⅞	Cavity Cap	A	20000	16000 18000	300 400	—	-28 to -72 -37 to -96	33 35	<b>24CP4-A</b>	
7½	21½ x 16⅞	Cavity Cap	H	20000	16000 18000	300 400	-65 to +350 -75 to +400	-28 to -72 -37 to -96	33 35	<b>24DP4-A</b>	
7½	21½ x 16⅞	Cavity Cap	A	22000	16000 20000	300 400	—	-28 to -72 -37 to -96	33 37	<b>24VP4-A</b>	
7½	21½ x 16⅞	Ratings and typical operating conditions are same as for type 24DP4-A									<b>24YP4</b>
7½	23½ x 18½	Metal-Shell Lip	F	18000	16000 16000	300 400	—	-28 to -72 -37 to -96	33 33	<b>27MP4</b>	
<b>Color Types</b>											
10⅜	11½ x 8½	Metal Flange	L	20000	For additional data, refer to technical bulletin available on request.				None	<b>15GP22</b>	
9⅞	19½ x 15¼	Metal-Shell Lip	M	25000	For additional data, refer to technical bulletin available on request.				None	<b>21AXP22</b>	
9⅞	19½ x 15¼	Metal Shell	N	25000	For additional data, refer to technical bulletin available on request.				None	<b>21AXP22-A</b>	

## NOTES

Note: All picture tubes shown have 6.3-volt/0.6-ampere heaters except types 9AP4 and 12AP4 which have 2.5-volt/2.1-ampere heaters.

⊙ Deflection factors (dc/in.) for typical operating conditions shown:

D<sub>1</sub> & D<sub>2</sub> (nearer screen)  
106 to 246

D<sub>1</sub> & D<sub>2</sub> (nearer base)  
150 to 204

• ULTOR is defined as the electrode, or the electrode in combination with one or more additional electrodes connected within the tube to it, to which is applied the highest dc voltage for accelerating the electrons in the beam prior to its deflection.

∞ Grid No. 2 connected to final high-voltage electrode within tube.

## BASING DIAGRAMS

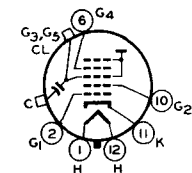

ULTOR =  $G_3 + G_5 + CL$   
FOCUSING ELECTRODE =  $G_4$

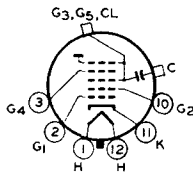

ULTOR =  $G_3 + G_5 + CL$   
FOCUSING ELECTRODE =  $G_4$

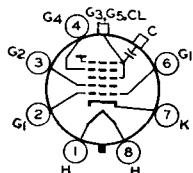

ULTOR =  $G_3 + G_5 + CL$   
FOCUSING ELECTRODE =  $G_4$

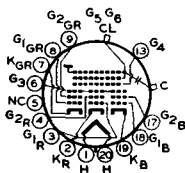

ULTOR =  $G_5 + G_6 + CL$   
FOCUSING ELECTRODE =  $G_3$

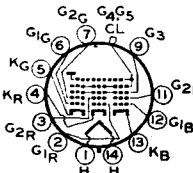

ULTOR =  $G_4 + G_5 + CL$   
FOCUSING ELECTRODE =  $G_3$



ULTOR =  $G_4 + G_5 + CL + R$   
FOCUSING ELECTRODE =  $G_3$

# Electron Tube Testing

The electron tube user—service man, experimenter, or non-technical radio listener—is interested in knowing the condition of his tubes, since they govern the performance of the device in which they are used. In order to determine the condition of a tube, some method of test is necessary. Because the operating capabilities and design features of a tube are indicated and described by its electrical characteristics, a tube is tested by measuring its characteristics and comparing them with values established as standard for that type. Tubes which read abnormally high with respect to the standard for the type are subject to criticism just the same as tubes which are too low.

Certain practical limitations are placed on the accuracy with which a tube test can be correlated with actual tube performance. These limitations make it impractical for the service man and dealer to employ complex and costly testing equipment having laboratory accuracy. Because the accuracy of the tube-testing device need be no greater than the accuracy of the correlation between test results and receiver performance, and since certain fundamental characteristics are virtually fixed by the manufacturing technique of leading tube manufacturers, it is possible to employ a relatively simple test in order to determine the serviceability of a tube.

In view of these factors, dealers and service men will find it economically expedient to obtain adequate accuracy and simplicity of operation by employing a device which indicates the status of a single characteristic. Whether the tube is satisfactory or unsatisfactory is judged from the test result of this single characteristic. Consequently, it is very desirable that the characteristic selected for the test be one which is truly representative of the tube's over-all condition.

The following information and circuits are given to describe and illustrate general theoretical and practical tube-tester considerations and not to provide information on the construction of a home-made tube tester. In addition to the problem of determining what tube characteristic is most representative of

performance capabilities in all types of receivers, the designer of a home-made tester faces the difficult problem of determining satisfactory limits for his particular tester. The obtaining of information of this nature, if it is to be accurate and useful, is a tremendous job. It requires the testing of a large number of tubes of each type, the testing of many types, and the correlation of these readings with performance in many kinds of equipment.

## Short-Circuit Test

The fundamental circuit of a short-circuit tester is shown in Fig. 92. Although this circuit is suitable for tetrodes and types having less than four electrodes, tubes of more electrodes may be tested by adding more indicator lamps to the circuit. Voltages are applied between the various electrodes with lamps in series with the electrode leads. The value of the voltages applied will depend

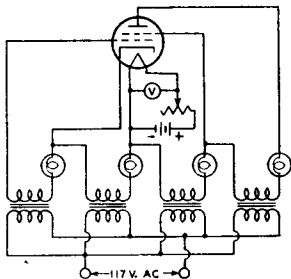

Fig. 92

on the type of tube being tested. Any two shorted electrodes complete a circuit and light one or more lamps. Since two electrodes may be just touching to give a high-resistance short, it is desirable that the indicating lamps operate on very low current. It is also desirable to maintain the filament or heater of the tube at its operating temperature during the short-circuit test, because short-circuits in a tube may sometimes occur only when the electrodes are heated.

## Selection of a Suitable Characteristic for Test

Some characteristics of a tube are far more important in determining its



operating worth than are others. The cost of building a device to measure any one of the more important characteristics may be considerably higher than that of a device which measures a less representative characteristic. Consequently, three methods of test will be discussed, ranging from relatively simple and inexpensive equipment to more elaborate, more accurate, and more costly devices.

An emission test is perhaps the simplest method of indicating a tube's condition. (Refer to *Diodes*, in ELECTRONS, ELECTRODES, AND ELECTRON TUBES SECTION, for a discussion of electron emission.) Since emission falls off as the tube wears out, low emission is indicative of the end of tube serviceability. However, the emission test is subject to limitations because it tests the tube under static conditions and does not take into account the actual operation of the tube. On the one hand, coated filaments, or cathodes, often develop active spots from which the emission is so great that the relatively small grid area adjacent to these spots cannot control the electron stream. Under these conditions, the total emission may indicate the tube to be normal although the tube is unsatisfactory. On the other hand, coated types of filaments are capable of such large emission that the tube will often operate satisfactorily after the emission has fallen far below the original value.

Fig. 93 shows the fundamental circuit diagram for an emission test. All of the electrodes of the tube, except the

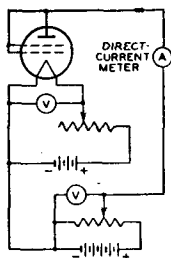

Fig. 93

cathode, are connected to the plate. The filament, or heater, is operated at rated voltage; after the tube has reached constant temperature, a low positive volt-

age is applied to the plate and the electron emission is read on the meter. Readings which are well below the average for a particular tube type indicate that the total number of available electrons has been so reduced that the tube is no longer able to function properly.

A transconductance test takes into account a fundamental operating principle of the tube. (This fact will be seen from the definition of transconductance in the Section on ELECTRON TUBE CHARACTERISTICS). It follows that transconductance tests, when properly made, permit better correlation between test results and actual performance than does a straight emission test.

There are two forms of transconductance test which can be utilized in a tube tester. In the first form (illustrated by Fig. 94 giving a fundamental circuit with a tetrode under test), appropriate operating voltages are applied to the

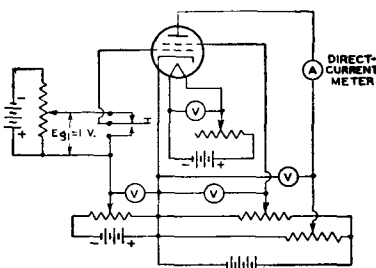

Fig. 94

electrodes of the tube. A plate current depending upon the electrode voltages will then be indicated by the meter. If the bias on the grid is then shifted by the application of a different grid voltage, a new plate-current reading is obtained. The difference between the two plate-current readings is indicative of the transconductance of the tube. This method of transconductance testing is commonly called the "grid-shift" method, and depends on readings under static conditions. The fact that this form of test is made under static conditions imposes limitations not encountered in the second form of test made under dynamic conditions.

The dynamic transconductance test illustrated in Fig. 95 gives a fundamental circuit with a tetrode under test. This

method is superior to the static transconductance test in that ac voltage is

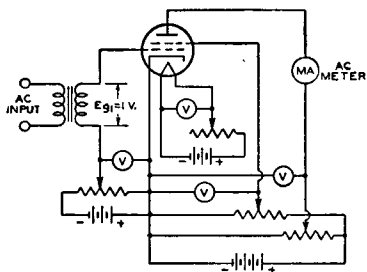

Fig. 96

applied to the grid. Thus, the tube is tested under conditions which approximate actual operating conditions. The alternating component of the plate current is read by means of an ac ammeter of the dynamometer type. The transconductance of the tube is equal to the ac plate current divided by the input-signal voltage. If a one-volt rms signal is applied to the grid, the plate-current-meter reading in milliamperes multiplied by one thousand is the value of transconductance in micromhos.

The power-output test probably gives the best correlation between test results and actual operating performance of a tube. In the case of voltage amplifiers, the power output is indicative of the amplification and output voltages obtainable from the tube. In the case of power-output tubes, the performance of the tube is closely checked. Consequently, although more complicated to set up, the power-output test will give closer correlation with actual performance than any other single test.

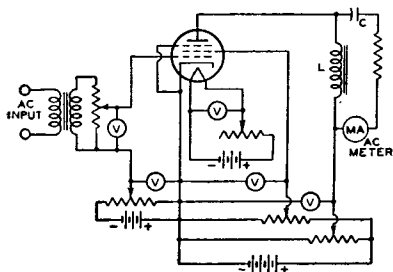

Fig. 96

Fig. 96 shows the fundamental circuit of a power-output test for class A

operation of tubes. The diagram illustrates the method for a pentode. The ac output voltage developed across the plate-load impedance (L) is indicated by the current meter. The current meter is isolated as far as the dc plate current is concerned by the capacitor (C). The power output can be calculated from the current reading and known load resistance. In this way, it is possible to determine the operating condition of the tube quite accurately.

Fig. 97 shows the fundamental circuit of a power-output test for class B operation of tubes. With ac voltage applied to the grid of the tube, the current in the plate circuit is read on a dc milliammeter. The power output of the tube is approximately equal to:

$$P_o = \frac{I_b^2 \times R_L}{0.405}$$

where  $P_o$  is the power output in watts,

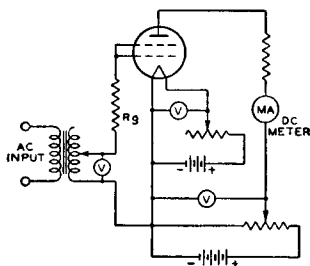

Fig. 97

$I_b$  is the dc current in amperes, and  $R_L$  is the load resistance in ohms.

### Essential Tube-Tester Requirements

1. It is desirable that the tester provide for a short-circuit test to be made prior to measurement of the tube's characteristics.
2. It is important that some means of controlling the voltages applied to the electrodes of the tube be provided. If the tester is ac operated, a line-voltage control permits the supply of proper electrode voltages.
3. It is essential that the rated voltage applied to the filament or heater be maintained accurately.
4. It is suggested that the characteristics test follow one of the methods described. The method selected and the quality of the parts used in the test will

depend upon the requirements of the user.

### **Tube-Tester Limitations**

A tube-testing device can only indicate the difference between a given tube's characteristics and those which are standard for that particular type. Since the operating conditions imposed upon a tube of a given type may vary within

wide limits, it is impossible for a tube-testing device to evaluate tubes in terms of performance capabilities for all applications. The tube tester, therefore, cannot be looked upon as a final authority in determining whether or not a tube is always satisfactory. Actual operating test in the equipment in which the tube is to be used will give the best possible indication of a tube's worth.

# Resistance-Coupled Amplifiers

Resistance-coupled, audio-frequency voltage amplifiers utilize simple components and are capable of providing essentially uniform amplification over a relatively wide frequency range.

## Suitable Tubes

In this section, data are given for over 50 types of tubes suitable for use in resistance-coupled circuits. These types include low- and high- $\mu$  triodes, twin triodes, triode-connected pentodes, and pentodes. The accompanying key to tube types will assist in locating the appropriate data chart.

## Circuit Advantages

For most of the types shown, the data pertain to operation with cathode bias; for all of the pentodes, the data pertain to operation with series screen-grid resistor. The use of a cathode-bias resistor where feasible and a series screen-grid resistor where applicable offer several advantages over fixed-voltage operation.

The advantages are: (1) effects of possible tube differences are minimized; (2) operation over a wide range of plate-supply voltages without appreciable change in gain is feasible; (3) the low frequency at which the amplifier cuts off is easily changed; and (4) tendency toward motorboating is minimized.

## Number of Stages

These advantages can be enhanced by the addition of suitable decoupling filters in the plate supply of each stage of a multi-stage amplifier. With proper filters, three or more amplifier stages can be operated from a single power-supply unit of conventional design without encountering any difficulties due to coupling through the power unit. When decoupling filters are not used, not more than two stages should be operated from a single power-supply unit.

Type	Chart No.	Type	Chart No.
1L4	1	6SH7	8
1S5	2	6SJ7 (GT)	19
1U4	3	6SL7-GT	7
1U5	2	6SN7-GTB	13
3AU6	8	6SQ7 (GT)	4
3AV6	20	6SR7	9
4AU6	8	6ST7	9
6AQ6	7	6SZ7	7
6AQ7-GT	7	6T8	7
6AT6	7	7AU7	10
6AU6	8	8CG7	13
6AV6	20	12AT6	7
6B8	5	12AU6	8
6BF6	9	12AU7	10
6C4	10	12AV6	20
6C5 (GT)	11	12AX7	20
6C6 } <sup>T</sup>	11	12C8	5
6C6 } <sup>P</sup>	14	12J5-GT	13
6C8-G	12	12J7-GT } <sup>T</sup>	11
6CG7	13	12J7-GT } <sup>P</sup>	14
6F5 (GT)	17	12Q7-GT	7
6F8-G	13	12S8-GT	4
6J5 (GT)	13	12SC7	16
6J7 (GT) } <sup>T</sup>	11	12SF5	17
6J7 (GT) } <sup>P</sup>	14	12SF7	18
6N7 (GT)	6	12SH7	8
6Q7 (GT)	7	12SJ7	19
6R7	7	12SL7-GT	7
6S7	15	12SN7-GT	13
6S8-GT	4	12SQ7	4
6SC7	16	12SR7	9
6SF5 (GT)	17	19T8	7
6SF7	18	75	4

T=Triode Connection  
P=Pentode Connection

## KEY TO CHARTS

**Symbols Used in Resistance-Coupled Amplifier Charts**

- C = Blocking Capacitor ( $\mu$ f).
- $C_k$  = Cathode Bypass Capacitor ( $\mu$ f).
- $C_{g2}$  = Screen-Grid Bypass Capacitor ( $\mu$ f).
- $E_{bb}$  = Plate-Supply Voltage (volts).  
Voltage at plate equals plate-supply voltage minus drop in  $R_p$  and  $R_k$ . See Note 1 below.
- $R_k$  = Cathode Resistor (ohms).
- $R_{g2}$  = Screen-Grid Resistor (megohms).
- $R_g$  = Grid Resistor (megohms) for following stage.
- $R_p$  = Plate Resistor (megohms).
- V.G. = Voltage Gain. At 5 volts (rms) output unless otherwise specified.
- $E_o$  = Peak Output Voltage (volts).  
This voltage is obtained across  $R_g$  (for following stage) at any frequency within the flat region of the output vs. frequency curve, and is for the condition where the signal level is adequate to swing the grid of the resistance-coupled amplifier tube to the point where its grid starts to draw current.

Note 1: For other supply voltages differing by as much as 50 per cent from those listed, the values of resistors, capacitors, and voltage gain are approximately correct. The value of voltage output, however, for any of these other supply voltages, equals the listed voltage output multiplied by the new plate-supply voltage divided by the plate-supply voltage corresponding to the listed voltage output.

**General Circuit Considerations**

In the discussions which follow, the frequency ( $f_2$ ) is that value at which the high-frequency response begins to fall off. The frequency ( $f_1$ ) is that value at which the low-frequency response drops

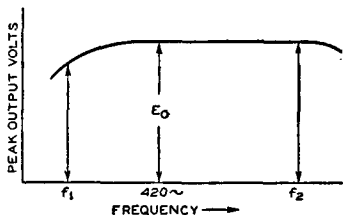

below a satisfactory value, as discussed below. Decoupling filters are not necessary for two stages or less. A variation

of 10 per cent in values of resistors and capacitors has only slight effect on performance. One-half-watt resistors are usually suitable for  $R_{g2}$ ,  $R_g$ ,  $R_p$ , and  $R_k$  resistors. Capacitors C and  $C_{g2}$  should have a working voltage equal to or greater than  $E_{bb}$ . Capacitor  $C_k$  may have a low working voltage in the order of 10 to 25 volts. Peak Input Voltage is equal to the Peak Output Voltage divided by the Voltage Gain.

**Triode Amplifier  
Heater-Cathode Type**

Capacitors C and  $C_k$  have been chosen to give an output voltage equal to 0.8  $E_o$  for a frequency ( $f_1$ ) of 100 cycles. For any other value of  $f_1$ , multiply values of C and  $C_k$  by  $100/f_1$ . In the

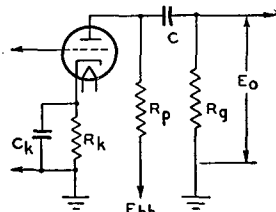

Diagram No. 1

case of capacitor  $C_k$ , the values shown in the charts are for an amplifier with dc heater excitation; when ac is used, depending on the character of the associated circuit, the gain, and the value of  $f_1$ , it may be necessary to increase the value of  $C_k$  to minimize hum disturbances. It may be desirable to operate the heater at a positive voltage of from 15 to 40 volts with respect to the cathode. The voltage output at  $f_1$  of "n" like stages equals  $(0.8)^n \times E_o$  where  $E_o$  is the peak output voltage of final stage. For an amplifier of typical construction, the value of  $f_2$  is well above the audio-frequency range for any value of  $R_p$ .

**Pentode Amplifier  
Filament-Type**

Capacitors C and  $C_{g2}$  have been chosen to give an output voltage equal to 0.8  $\times E_o$  for a frequency ( $f_1$ ) of 100 cycles. For any other value of  $f_1$ , multiply values of C and  $C_{g2}$  by  $100/f_1$ . The voltage output at  $f_1$  for "n" like stages equals  $(0.8)^n \times E_o$  where  $E_o$  is peak out-

put voltage of final stage. For an amplifier of typical construction, and for  $R_p$  values of 0.1, 0.25, and 0.5 megohm, approximate values of  $f_2$  are 20000, 10000, and 5000 cps, respectively. Note: The

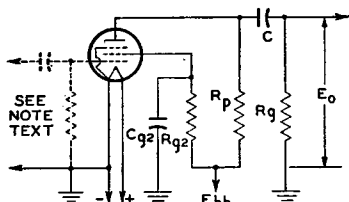

Diagram No. 2

values of input-coupling capacitor in microfarads and of grid resistor in megohms should be such that their product lies between 0.02 and 0.1. Values commonly used are 0.005  $\mu$ f and 10 megohms.

### Pentode Amplifier Heater-Cathode Type

Capacitors C,  $C_k$ , and  $C_{g2}$  have been chosen to give an output voltage equal to  $0.7 \times E_o$  for a frequency ( $f_1$ ) of 100 cycles. For any other value of  $f_1$ , multiply values of C,  $C_k$ , and  $C_{g2}$  by  $100/f_1$ . In the case of capacitor  $C_k$ , the values shown in the charts are for an amplifier with dc heater excitation; when

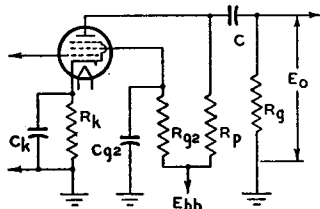

Diagram No. 3

ac is used, depending on the character of the associated circuits, the voltage gain, and the value of  $f_1$ , it may be necessary to increase the value of  $C_k$  to minimize hum disturbances. It may be de-

sirable to operate the heater at a positive voltage of from 15 to 40 volts with respect to the cathode. The voltage output at  $f_1$  for "n" like stages equals  $(0.7)^n \times E_o$  where  $E_o$  is peak output voltage of final stage. For an amplifier of typical construction, and for  $R_p$  values of 0.1, 0.25, and 0.5 megohm, approximate values of  $f_2$  are 20000, 10000, and 5000 cps, respectively.

### Phase Inverters

Information given for triode amplifiers, in general, applies to this case. Capacitors C have been chosen to give an output voltage equal to  $0.9 \times E_o$  for a frequency ( $f_1$ ) of 100 cycles. For any other value of  $f_1$ , multiply values of C by  $100/f_1$ . The signal input is applied to

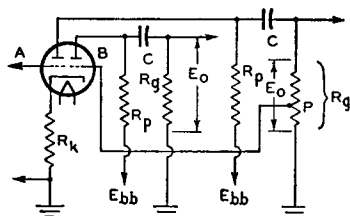

Diagram No. 4

grid of triode unit A. Grid of triode unit B obtains its signal from a tap (P) on the grid resistor ( $R_g$ ) in the output circuit of unit A. The tap is chosen so as to make the voltage output of unit B equal to that of unit A. Its location is determined by the voltage gain values given in the charts. For example, if V.G. is 20 (from the charts), P is chosen so as to supply  $1/20$  of the voltage across  $R_g$  to the grid of unit B. For phase-inverter service, the cathode resistor is left unbypassed unless a bypass capacitor is necessary to minimize hum; omission of the bypass capacitor assists in balancing the output stages. The value of  $R_k$  is specified on the basis that both units are operating simultaneously at the same values of plate load and plate voltage.

# RCA Receiving Tube Manual

(See page 307 for explanation of column headings)

E <sub>bb</sub>	R <sub>p</sub>	R <sub>g</sub>	R <sub>g2</sub>	R <sub>k</sub>	C <sub>g2</sub>	C <sub>k</sub>	C	E <sub>o</sub>	V.G.
45	0.22	0.22	0.24	-	0.071	-	0.011	12	16★
		0.47	0.32	-	0.06	-	0.006	14	23
		1.0	0.39	-	0.056	-	0.0035	18	30
	0.47	0.47	0.57	-	0.049	-	0.0052	14	22
		1.0	0.64	-	0.047	-	0.0035	17	30
		2.2	0.74	-	0.044	-	0.0018	19	33
	1.0	1.0	1.1	-	0.036	-	0.0028	14	28
		2.2	1.25	-	0.035	-	0.0018	16	32
		3.3	1.45	-	0.032	-	0.0015	18	38
90	0.22	0.22	0.4	-	0.089	-	0.011	26	28
		0.47	0.46	-	0.081	-	0.0055	36	36
		1.0	0.47	-	0.08	-	0.0035	42	41
	0.47	0.47	0.84	-	0.07	-	0.0055	30	34
		1.0	0.9	-	0.069	-	0.003	38	42
		2.2	1.0	-	0.062	-	0.0018	40	50
	1.0	1.0	2.0	-	0.045	-	0.0028	30	45
		2.2	2.1	-	0.045	-	0.0018	35	55
		3.3	2.2	-	0.044	-	0.0012	40	61
135	0.22	0.22	0.5	-	0.09	-	0.011	42	34
		0.47	0.63	-	0.074	-	0.0055	54	51
		1.0	0.67	-	0.072	-	0.0035	57	60
	0.47	0.47	1.1	-	0.071	-	0.005	47	49
		1.0	1.4	-	0.06	-	0.0028	54	68
		2.2	1.5	-	0.051	-	0.0018	60	87
	1.0	1.0	2.1	-	0.059	-	0.0025	45	53
		2.2	2.4	-	0.054	-	0.0018	57	88
		3.3	2.7	-	0.049	-	0.0012	61	91
45	0.22	0.22	0.26	-	0.042	-	0.013	14	17
		0.47	0.36	-	0.035	-	0.006	17	24
		1.0	0.4	-	0.034	-	0.004	18	28
	0.47	0.47	0.82	-	0.025	-	0.0055	14	25
		1.0	1.0	-	0.023	-	0.003	17	33
		2.2	1.1	-	0.022	-	0.002	18	38
	1.0	1.0	1.9	-	0.019	-	0.003	14	31
		2.2	2.0	-	0.019	-	0.002	17	38
		3.3	2.2	-	0.018	-	0.0015	18	43
90	0.22	0.22	0.5	-	0.05	-	0.011	31	25
		0.47	0.59	-	0.05	-	0.006	37	34
		1.0	0.67	-	0.042	-	0.003	40	41
	0.47	0.47	1.2	-	0.035	-	0.005	31	37
		1.0	1.4	-	0.034	-	0.003	36	47
		2.2	1.6	-	0.031	-	0.002	40	57
	1.0	1.0	2.5	-	0.026	-	0.003	31	45
		2.2	2.9	-	0.025	-	0.002	36	58
		3.3	3.1	-	0.024	-	0.0012	38	66
135	0.22	0.22	0.66	-	0.052	-	0.011	45	31
		0.47	0.71	-	0.051	-	0.006	56	41
		1.0	0.86	-	0.039	-	0.003	60	54
	0.47	0.47	1.45	-	0.042	-	0.005	46	44
		1.0	1.8	-	0.034	-	0.003	54	62
		2.2	1.9	-	0.033	-	0.002	60	71
	1.0	1.0	3.1	-	0.03	-	0.003	45	56
		2.2	3.7	-	0.029	-	0.0015	53	76
		3.3	4.3	-	0.026	-	0.0014	56	88

1

1L4

See Circuit Diagram 2

2

1S5  
1U5

See Circuit Diagram 2

★ At 4 volts (rms) output.

# RCA Receiving Tube Manual

(See page 307 for explanation of column headings)

Ebb	R <sub>p</sub>	R <sub>g</sub>	R <sub>g2</sub>	R <sub>k</sub>	C <sub>g2</sub>	C <sub>k</sub>	C	E <sub>o</sub>	V.G.	
3	45	0.22	0.22	0.06	-	0.046	-	0.011	11	23
			0.47	0.07	-	0.045	-	0.006	15	33
			1.0	0.011	-	0.04	-	0.003	17	39
	45	0.47	0.47	0.34	-	0.025	-	0.005	13	34
			1.0	0.44	-	0.022	-	0.003	16	46
			2.2	0.5	-	0.022	-	0.002	18	55
	45	1.0	1.0	1.0	-	0.016	-	0.003	14	43
			2.2	1.0	-	0.016	-	0.002	17	51
			3.3	1.1	-	0.015	-	0.001	17	60
90	0.22	0.22	0.3	-	0.046	-	0.01	27	37	
		0.47	0.36	-	0.04	-	0.006	36	54	
		1.0	0.4	-	0.038	-	0.003	39	63	
	90	0.47	0.47	0.9	-	0.027	-	0.0045	29	61
			1.0	1.0	-	0.023	-	0.003	35	82
			2.2	1.1	-	0.022	-	0.002	38	96
	90	1.0	1.0	1.9	-	0.02	-	0.0025	30	77
			2.2	2.0	-	0.02	-	0.002	35	98
			3.3	2.2	-	0.018	-	0.001	37	114
135	0.22	0.22	0.4	-	0.052	-	0.011	44	46	
		0.47	0.49	-	0.037	-	0.005	55	71	
		1.0	0.52	-	0.034	-	0.003	60	83	
	135	0.47	0.47	1.1	-	0.029	-	0.0045	45	77
			1.0	1.3	-	0.023	-	0.003	53	106
			2.2	1.4	-	0.022	-	0.002	59	123
	135	1.0	1.0	2.3	-	0.021	-	0.0025	45	104
			2.2	2.5	-	0.019	-	0.0015	53	136
			3.3	2.9	-	0.016	-	0.001	56	163

See Circuit Diagram 2

1U4

4	90	0.1	0.1	-	6300	-	2.2	0.02	3	23
			0.25	-	6600	-	1.7	0.01	5	29
			0.5	-	6700	-	1.7	0.006	6	31★
	90	0.25	0.25	-	10000	-	1.24	0.01	5	34
			0.5	-	11000	-	1.07	0.006	7	40★
			1.0	-	11500	-	0.9	0.003	10	40
	90	0.5	0.5	-	16200	-	0.75	0.005	7	39
			1.0	-	16600	-	0.7	0.003	10	44
			2.0	-	17400	-	0.65	0.0015	13	48
180	0.1	0.1	-	2600	-	3.3	0.025	16	29	
		0.25	-	2900	-	2.9	0.015	22	36	
		0.5	-	3000	-	2.7	0.007	23	37	
	180	0.25	0.25	-	4300	-	2.1	0.015	21	43
			0.5	-	4800	-	1.8	0.007	28	50
			1.0	-	5300	-	1.5	0.004	33	53
	180	0.5	0.5	-	7000	-	1.3	0.007	25	52
			1.0	-	8000	-	1.1	0.004	33	57
			2.0	-	8800	-	0.9	0.002	38	58
300	0.1	0.1	-	1900	-	4.0	0.03	31	31	
		0.25	-	2200	-	3.5	0.015	41	39	
		0.5	-	2300	-	3.0	0.007	45	42	
	300	0.25	0.25	-	3300	-	2.7	0.015	42	48
			0.5	-	3900	-	2.0	0.007	51	53
			1.0	-	4200	-	1.8	0.004	60	56
	300	0.5	0.5	-	5300	-	1.6	0.007	47	58
			1.0	-	6100	-	1.3	0.004	62	60
			2.0	-	7000	-	1.2	0.002	67	63

● - At 2 volts (rms) output. ■ At 3 volts (rms) output. ★ At 4 volts (rms) output.

6S8-GT  
6SQ7  
6SQ7-GT  
12SQ7  
12SQ7-GT  
75

See Circuit Diagram 1



# RCA Receiving Tube Manual

(See page 307 for explanation of column headings)

Ebb	R <sub>p</sub>	R <sub>g</sub>	R <sub>g2</sub>	R <sub>k</sub>	C <sub>g2</sub>	C <sub>k</sub>	C	E <sub>o</sub>	V.G.
90	0.1	0.1	0.37	2000	0.07	3.0	0.02	19	24
		0.25	0.5	2200	0.07	3.0	0.01	28	33
		0.5	0.6	2000	0.06	2.8	0.006	29	37
	0.25	0.25	1.18	3500	0.04	1.9	0.008	26	43
		0.5	1.1	3500	0.04	2.1	0.007	33	55
		1.0	1.35	3500	0.04	1.9	0.003	32	65
	0.5	0.5	2.6	5000	0.04	1.5	0.004	22	63
		1.0	2.8	6000	0.04	1.55	0.003	29	85
		2.0	2.9	6200	0.04	1.5	0.003	27	100
180	0.1	0.1	0.44	1000	0.08	4.4	0.02	30	30
		0.25	0.5	1200	0.08	4.4	0.015	52	41
		0.5	0.6	1200	0.07	4.0	0.008	53	46
	0.25	0.25	1.18	1900	0.05	2.7	0.01	39	55
		0.5	1.2	2100	0.06	3.2	0.007	55	69
		1.0	1.5	2200	0.05	3.0	0.003	53	83
	0.5	0.5	2.6	3300	0.04	2.1	0.005	47	81
		1.0	2.8	3500	0.04	2.0	0.003	55	115
		2.0	3.0	3500	0.04	2.2	0.002	53	116
300	0.1	0.1	0.5	950	0.09	4.6	0.025	60	36
		0.25	0.55	1100	0.09	5.0	0.015	89	47
		0.5	0.6	900	0.08	4.8	0.009	86	54
	0.25	0.25	1.2	1500	0.06	3.2	0.015	70	64
		0.5	1.2	1600	0.06	3.5	0.008	100	79
		1.0	1.5	1800	0.08	4.0	0.004	95	100
	0.5	0.5	2.7	2400	0.05	2.5	0.006	80	96
		1.0	2.9	2500	0.05	2.3	0.003	120	150
		2.0	3.4	2800	0.05	2.8	0.0025	90	145
90	0.1	0.1	-	1900*	-	-	0.025	13	16
		0.25	-	2250*	-	-	0.01	19	19
		0.5	-	2500*	-	-	0.006	20	20
	0.25	0.25	-	4050*	-	-	0.01	16	20
		0.5	-	4950*	-	-	0.006	20	22
		1.0	-	5400*	-	-	0.003	24	23
	0.5	0.5	-	7000*	-	-	0.006	18	22
		1.0	-	8500*	-	-	0.003	23	23
		2.0	-	9650*	-	-	0.0015	26	23
180	0.1	0.1	-	1300*	-	-	0.03	35	19
		0.25	-	1700*	-	-	0.015	46	21
		0.5	-	1950*	-	-	0.007	50	22
	0.25	0.25	-	2950*	-	-	0.015	40	23
		0.5	-	3800*	-	-	0.007	50	24
		1.0	-	4300*	-	-	0.0035	57	24
	0.5	0.5	-	5250*	-	-	0.007	44	24
		1.0	-	6600*	-	-	0.0035	54	25
		2.0	-	7650*	-	-	0.002	61	25
300	0.1	0.1	-	1150*	-	-	0.03	60	20
		0.25	-	1500*	-	-	0.015	83	22
		0.5	-	1750*	-	-	0.007	86	23
	0.25	0.25	-	2650*	-	-	0.015	75	23
		0.5	-	3400*	-	-	0.0055	87	24
		1.0	-	4000*	-	-	0.003	100	24
	0.5	0.5	-	4850*	-	-	0.0055	76	23
		1.0	-	6100*	-	-	0.003	94	24
		2.0	-	7150*	-	-	0.0015	104	24

5

6B8  
12C8

See Circuit  
Diagram 3

6

6N7#  
6N7-GT#

See Circuit  
Diagram 4

# The cathodes of the two units have a common terminal  
\*Values shown are for phase-inverter service.

# RCA Receiving Tube Manual

(See page 307 for explanation of column headings)

E <sub>bb</sub>	R <sub>p</sub>	R <sub>g</sub>	R <sub>g2</sub>	R <sub>k</sub>	C <sub>g2</sub>	C <sub>k</sub>	C	E <sub>o</sub>	V.G.	
<b>7</b>	90	0.1	0.1	-	4200	-	2.5	0.025	5.4	22 <sup>●</sup>
			0.22	-	4600	-	2.2	0.014	7.5	27 <sup>●</sup>
			0.47	-	4800	-	2.0	0.0065	9.1	30 <sup>●</sup>
	0.22	0.22	-	7000	-	1.5	0.013	7.3	30 <sup>●</sup>	30 <sup>■</sup>
		0.47	-	7800	-	1.3	0.007	10	34 <sup>■</sup>	
		1.0	-	8100	-	1.1	0.0035	12	37 <sup>★</sup>	
	0.47	0.47	-	12000	-	0.83	0.006	10	36 <sup>■</sup>	
		1.0	-	14000	-	0.7	0.0035	14	39 <sup>★</sup>	
		2.2	-	15000	-	0.6	0.002	16	41 <sup>★</sup>	
180	0.1	0.1	-	1900	-	3.6	0.027	19	30 <sup>★</sup>	
		0.22	-	2200	-	3.1	0.014	25	35	
		0.47	-	2500	-	2.8	0.0065	32	37	
	0.22	0.22	-	3400	-	2.2	0.014	24	38	
		0.47	-	4100	-	1.7	0.0065	34	42	
		1.0	-	4600	-	1.5	0.0035	38	44	
	0.47	0.47	-	6600	-	1.1	0.0065	29	44	
		1.0	-	8100	-	0.9	0.0035	38	46	
		2.2	-	9100	~	0.8	0.002	43	47	
300	0.1	0.1	-	1500	-	4.4	0.027	40	34	
		0.22	-	1800	-	3.6	0.014	54	38	
		0.47	-	2100	-	3.0	0.0065	63	41	
	0.22	0.22	-	2600	-	2.5	0.013	51	42	
		0.47	-	3200	-	1.9	0.0065	65	46	
		0.1	-	3700	-	1.6	0.0035	77	48	
	0.47	0.47	-	5200	-	1.2	0.006	61	48	
		1.0	-	6300	-	1.0	0.0035	74	50	
		2.2	-	7200	-	0.9	0.002	85	51	
<b>8</b>	90	0.1	0.1	0.07	1800	0.11	9.0	0.021	25	52
			0.22	0.09	2100	0.1	8.2	0.012	32	72
			0.47	0.096	2100	0.1	8.0	0.0065	37	88
	0.22	0.22	0.25	3100	0.08	6.2	0.009	25	72	
		0.47	0.26	3200	0.078	5.8	0.0055	32	99	
		1.0	0.35	3700	0.085	5.1	0.003	34	125	
	0.47	0.47	0.75	6300	0.042	3.4	0.0035	27	102	
		1.0	0.75	6500	0.042	3.3	0.0027	32	126	
		2.2	0.8	6700	0.04	3.2	0.0018	36	152	
180	0.1	0.1	0.12	800	0.15	14.1	0.021	57	74	
		0.22	0.15	900	0.126	14.0	0.012	82	116	
		0.47	0.19	1000	0.1	12.5	0.006	81	141	
	0.22	0.22	0.38	1500	0.09	9.6	0.009	59	130	
		0.47	0.43	1700	0.08	8.7	0.005	67	171	
		1.0	0.6	1900	0.066	8.1	0.003	71	200	
	0.47	0.47	0.9	3100	0.06	5.7	0.0045	54	172	
		1.0	1.0	3400	0.05	5.4	0.0028	65	232	
		2.2	1.1	3600	0.04	3.6	0.0019	74	272	
300	0.1	0.1	0.2	500	0.13	18.0	0.019	76	109	
		0.22	0.24	600	0.11	16.4	0.011	103	145	
		0.47	0.26	700	0.11	15.3	0.006	129	168	
	0.22	0.22	0.42	1000	0.1	12.4	0.009	92	164	
		0.47	0.5	1000	0.098	12.0	0.007	108	230	
		1.0	0.55	1100	0.09	11.0	0.003	122	262	
	0.47	0.47	1.0	1800	0.075	8.0	0.0045	94	248	
		1.0	1.1	1900	0.065	7.6	0.0028	105	318	
		2.2	1.2	2100	0.06	7.3	0.0018	122	371	

● - At 2 volts (rms) output. ■ - At 3 volts (rms) output. ★ - At 4 volts (rms) output.  
 ● - One triode unit.

**7**  
 6AQ6  
 6AQ7-GT  
 6AT6  
 6Q7  
 6Q7-GT  
 6SL7-GT<sup>●</sup>  
 6SZ7  
 6T8  
 12AT6  
 12Q7-GT  
 12SL7-GT<sup>●</sup>  
 19T8

See Circuit Diagram 1

**8**  
 3AU6  
 4AU6  
 6AU6  
 6SH7  
 12AU6  
 12SH7

See Circuit Diagram 3

# RCA Receiving Tube Manual

(See page 307 for explanation of column headings)

Ebb	R <sub>p</sub>	R <sub>g</sub>	R <sub>g2</sub>	R <sub>k</sub>	C <sub>g2</sub>	C <sub>k</sub>	C	E <sub>o</sub>	V.G.
90	0.047	0.047	-	2200	-	2.5	0.063	14	9
		0.1	-	2800	-	2.0	0.033	18	10
		0.22	-	3200	-	1.7	0.015	20	10
	0.1	0.1	-	4100	-	1.4	0.032	13	10
		0.22	-	5400	-	1.0	0.013	20	11
		0.47	-	6400	-	0.9	0.007	24	11
	0.22	0.22	-	8500	-	0.67	0.015	18	11
		0.47	-	12000	-	0.5	0.0065	23	11
		1.0	-	14000	-	0.43	0.0035	27	11
180	0.047	0.047	-	2000	-	2.9	0.062	32	10
		0.1	-	2500	-	2.2	0.033	42	10
		0.22	-	3000	-	1.9	0.016	47	11
	0.1	0.1	-	3800	-	1.5	0.033	36	11
		0.22	-	5100	-	1.1	0.015	47	11
		0.47	-	6200	-	0.9	0.007	55	12
	0.22	0.22	-	8000	-	0.73	0.015	41	12
		0.47	-	11000	-	0.5	0.007	54	12
		1.0	-	13000	-	0.4	0.0035	69	12
300	0.047	0.047	-	1800	-	3.0	0.063	58	10
		0.1	-	2400	-	2.4	0.033	74	11
		0.22	-	2900	-	2.0	0.016	85	11
	0.1	0.1	-	3600	-	1.6	0.033	65	12
		0.22	-	5000	-	1.2	0.015	85	12
		0.47	-	6200	-	0.95	0.007	96	12
	0.22	0.22	-	7800	-	0.73	0.015	74	12
		0.47	-	11000	-	0.5	0.007	95	12
		1.0	-	13000	-	0.43	0.0035	106	12
90	0.047	0.047	-	1600	-	3.2	0.061	9	10 <sup>■</sup>
		0.1	-	1800	-	2.5	0.033	11	11★
		0.22	-	2000	-	2.0	0.015	14	11
	0.1	0.1	-	3000	-	1.6	0.032	10	11★
		0.22	-	3800	-	1.1	0.015	15	11
		0.47	-	4500	-	1.0	0.007	18	11
	0.22	0.22	-	6800	-	0.7	0.015	14	11
		0.47	-	9500	-	0.5	0.0065	20	11
		1.0	-	11500	-	0.43	0.0035	24	11
180	0.047	0.047	-	920	-	3.9	0.062	20	11
		0.1	-	1200	-	2.9	0.037	26	12
		0.22	-	1400	-	2.5	0.016	29	12
	0.1	0.1	-	2000	-	1.9	0.032	24	12
		0.22	-	2800	-	1.4	0.016	33	12
		0.47	-	3600	-	1.1	0.007	40	12
	0.22	0.22	-	5300	-	0.8	0.015	31	12
		0.47	-	8300	-	0.56	0.007	44	12
		1.0	-	10000	-	0.48	0.0035	54	12
300	0.047	0.047	-	870	-	4.1	0.065	38	12
		0.1	-	1200	-	3.0	0.034	52	12
		0.22	-	1500	-	2.4	0.016	68	12
	0.1	0.1	-	1900	-	1.9	0.032	44	12
		0.22	-	3000	-	1.3	0.016	68	12
		0.47	-	4000	-	1.1	0.007	80	12
	0.22	0.22	-	5300	-	0.9	0.015	57	12
		0.47	-	8800	-	0.52	0.007	82	12
		1.0	-	11000	-	0.46	0.0035	92	12

■ At 3 volts (rms) output. ★ At 4 volts (rms) output. ● One triode unit.

9

**6BF6  
6R7  
6SR7  
6ST7  
12SR7**

See Circuit Diagram 1

10

**6C4  
7AU7\*  
12AU7\***

See Circuit Diagram 1

# RCA Receiving Tube Manual

(See page 307 for explanation of column headings)

11

**6C5  
6C5-GT**

As Triode:

**6C6  
6J7  
6J7-GT  
6W7-G  
12J7-GT  
57**

See Circuit  
Diagram 1

E <sub>bb</sub>	R <sub>p</sub>	R <sub>g</sub>	R <sub>g2</sub>	R <sub>k</sub>	C <sub>g2</sub>	C <sub>k</sub>	C	E <sub>o</sub>	V.G.
90	0.05	0.05	-	2800	-	2.0	0.05	14	9
		0.1	-	3400	-	1.62	0.025	17	9
		0.25	-	3800	-	1.3	0.01	20	10
	0.1	0.1	-	4800	-	1.12	0.025	16	10
		0.25	-	6400	-	0.84	0.01	22	11
		0.5	-	7500	-	0.66	0.005	23	12
	0.25	0.25	-	11400	-	0.52	0.01	18	12
		0.5	-	14500	-	0.4	0.006	23	12
		1.0	-	17300	-	0.33	0.004	26	13
180	0.05	0.05	-	2200	-	2.2	0.055	34	10
		0.1	-	2700	-	2.1	0.03	45	11
		0.25	-	3100	-	1.85	0.015	54	11
	0.1	0.1	-	3900	-	1.7	0.035	41	12
		0.25	-	5300	-	1.25	0.015	54	12
		0.5	-	6200	-	1.2	0.008	55	13
	0.25	0.25	-	9500	-	0.74	0.015	44	13
		0.5	-	12300	-	0.55	0.008	52	13
		1.0	-	14700	-	0.47	0.004	59	13
300	0.05	0.05	-	2100	-	3.16	0.075	57	11
		0.1	-	2600	-	2.3	0.04	70	11
		0.25	-	3100	-	2.2	0.015	83	12
	0.1	0.1	-	3800	-	1.7	0.035	65	12
		0.25	-	5300	-	1.3	0.015	84	13
		0.5	-	6000	-	1.17	0.008	88	13
	0.25	0.25	-	9600	-	0.9	0.015	73	13
		0.5	-	12300	-	0.59	0.008	85	14
		1.0	-	14000	-	0.37	0.003	97	14

12

**6C8-G\***

See Circuit  
Diagram 1

90	0.1	0.1	-	3040	-	2.34	0.028	13	18
		0.25	-	3700	-	1.48	0.0115	17	20
		0.5	-	4520	-	1.29	0.006	19	21
	0.25	0.25	-	6770	-	0.95	0.011	15	21
		0.5	-	7870	-	0.81	0.0065	19	23
		1.0	-	8830	-	0.69	0.0035	21	23
	0.5	0.5	-	12400	-	0.51	0.006	16	22
		1.0	-	15000	-	0.43	0.0035	20	24
		2.0	-	16500	-	0.38	0.0015	25	24
180	0.1	0.1	-	2420	-	2.34	0.028	30	20
		0.25	-	3080	-	1.84	0.012	40	22
		0.5	-	3560	-	1.6	0.0065	45	23
	0.25	0.25	-	5170	-	1.25	0.012	35	24
		0.5	-	6560	-	0.95	0.007	45	25
		1.0	-	7550	-	0.85	0.0035	50	26
	0.5	0.5	-	9840	-	0.66	0.007	38	25
		1.0	-	12500	-	0.5	0.004	44	26
		2.0	-	15600	-	0.44	0.0015	51	26
300	0.1	0.1	-	2120	-	3.93	0.037	55	22
		0.25	-	2840	-	2.01	0.013	73	23
		0.5	-	3250	-	1.79	0.007	80	25
	0.25	0.25	-	4750	-	1.29	0.013	64	25
		0.5	-	6100	-	0.96	0.0065	80	26
		1.0	-	7100	-	0.77	0.004	90	27
	0.5	0.5	-	9000	-	0.67	0.007	67	27
		1.0	-	11500	-	0.48	0.004	83	27
		2.0	-	14500	-	0.37	0.002	96	28

● One triode unit.

# RCA Receiving Tube Manual

(See page 307 for explanation of column headings)

Ebb	R <sub>p</sub>	R <sub>g</sub>	R <sub>g2</sub>	R <sub>k</sub>	C <sub>g2</sub>	C <sub>k</sub>	C	E <sub>o</sub>	V.G.
90	0.047	0.047	-	1870	-	3.1	0.063	14	13
		0.1	-	2230	-	2.5	0.031	18	14
		0.22	-	2500	-	2.1	0.016	20	14
	0.1	0.1	-	3370	-	1.8	0.034	15	14
		0.22	-	4100	-	1.3	0.015	20	14
		0.47	-	4800	-	1.1	0.006	23	15
	0.22	0.22	-	7000	-	0.80	0.013	16	14
		0.47	-	9100	-	0.65	0.007	22	14
		1.00	-	10500	-	0.60	0.004	25	15
180	0.047	0.047	-	1500	-	3.6	0.066	33	14
		0.1	-	1860	-	2.9	0.055	41	14
		0.22	-	2160	-	2.2	0.015	47	15
	0.1	0.1	-	2750	-	1.8	0.028	35	15
		0.22	-	3550	-	1.4	0.015	45	15
		0.47	-	4140	-	1.3	0.007	51	16
	0.22	0.22	-	5150	-	1.0	0.016	36	16
		0.47	-	7000	-	0.71	0.007	45	16
		1.00	-	7800	-	0.61	0.004	51	16
300	0.047	0.047	-	1300	-	3.6	0.061	59	14
		0.1	-	1580	-	3.0	0.032	73	15
		0.22	-	1800	-	2.5	0.015	83	16
	0.1	0.1	-	2500	-	1.9	0.031	68	16
		0.22	-	3130	-	1.4	0.014	82	16
		0.47	-	3900	-	1.2	0.0065	96	16
	0.22	0.22	-	4800	-	0.95	0.015	68	16
		0.47	-	6500	-	0.69	0.0065	85	16
		1.00	-	7800	-	0.58	0.0035	96	16
90	0.1	0.1	0.37	1200	0.05	5.2	0.02	17	41
		0.25	0.44	1100	0.05	5.3	0.01	22	55
		0.5	0.44	1300	0.05	4.8	0.006	33	66
	0.25	0.25	1.1	2400	0.03	3.7	0.008	23	70
		0.5	1.18	2600	0.03	3.2	0.005	32	85
		1.0	1.4	3600	0.025	2.5	0.003	33	92
	0.5	0.5	2.18	4700	0.02	2.3	0.005	28	93
		1.0	2.6	5500	0.05	2.0	0.0025	29	120
		2.0	2.7	5500	0.02	2.0	0.0015	27	140
180	0.1	0.1	0.44	1000	0.05	6.5	0.02	42	51
		0.25	0.5	750	0.05	6.7	0.01	52	69
		0.5	0.5	800	0.05	6.7	0.006	59	83
	0.25	0.25	1.1	1200	0.04	5.2	0.008	41	93
		0.5	1.18	1600	0.04	4.3	0.005	60	118
		1.0	1.4	2000	0.04	3.8	0.0035	60	140
	0.5	0.5	2.45	2600	0.03	3.2	0.005	45	135
		1.0	2.9	3100	0.025	2.5	0.0025	56	165
		2.0	2.7	3500	0.02	2.8	0.0015	60	165
300	0.1	0.1	0.44	500	0.07	8.5	0.02	55	61
		0.25	0.5	450	0.07	8.3	0.01	81	82
		0.5	0.53	600	0.06	8.0	0.006	96	94
	0.25	0.25	1.18	1100	0.04	5.5	0.008	81	104
		0.5	1.18	1200	0.04	5.4	0.005	104	140
		1.0	1.45	1300	0.05	5.8	0.005	110	185
	0.5	0.5	2.45	1700	0.04	4.2	0.005	75	161
		1.0	2.9	2200	0.04	4.1	0.003	97	200
		2.0	2.95	2300	0.04	4.0	0.0025	100	230

13

**6CG7 •**  
**6F8-G •**  
**6J5**  
**6J5-GT**  
**6SN7-GTB •**  
**12J5-GT**  
**12SN7-GT •**

See Circuit Diagram 1

14

**6C6**  
**6J7**  
**6J7-G**  
**6J7-GT**  
**12J7-GT**  
**57**

See Circuit Diagram 3

• One triode unit.

# RCA Receiving Tube Manual

(See page 307 for explanation of column headings)

15

6S7

See Circuit Diagram 3

E <sub>bb</sub>	R <sub>p</sub>	R <sub>g</sub>	R <sub>g2</sub>	R <sub>k</sub>	C <sub>g2</sub>	C <sub>k</sub>	C	E <sub>o</sub>	V.G.*
90	0.1	0.1	0.59	870	0.065	5.1	0.018	16	33
		0.25	0.65	900	0.061	5.0	0.01	21	47
		0.5	0.7	910	0.057	4.58	0.007	23	54
	0.25	0.25	1.5	1440	0.044	3.38	0.007	14	56
		0.5	1.6	1520	0.044	3.23	0.0055	18	66
		1.0	1.7	1560	0.043	3.22	0.004	19	77
	0.5	0.5	3.2	2620	0.029	2.04	0.004	12	70
		1.0	3.5	2800	0.03	1.95	0.0026	15	84
		2.0	3.7	3000	0.031	1.92	0.0024	16	94
180	0.1	0.1	0.58	530	0.073	7.2	0.017	33	47
		0.25	0.68	540	0.07	6.9	0.01	43	66
		0.5	0.71	540	0.065	6.6	0.0063	48	75
	0.25	0.25	1.6	850	0.05	4.6	0.0071	33	79
		0.5	1.8	890	0.044	4.7	0.005	40	104
		1.0	1.9	950	0.046	4.4	0.0037	44	118
	0.5	0.5	3.3	1410	0.041	3.5	0.0041	30	109
		1.0	3.6	1520	0.037	3.0	0.003	38	134
		2.0	3.8	1600	0.031	2.9	0.0024	42	147
300	0.1	0.1	0.59	430	0.007	8.5	0.0167	57	57
		0.25	0.67	440	0.071	8.0	0.01	75	78
		0.5	0.71	440	0.071	8.0	0.0066	82	89
	0.25	0.25	1.7	620	0.058	6.0	0.0071	54	98
		0.5	1.95	650	0.057	5.8	0.005	66	122
		1.0	2.1	700	0.055	5.2	0.0036	76	136
	0.5	0.5	3.6	1000	0.04	4.1	0.0037	52	136
		1.0	3.9	1080	0.041	3.9	0.0029	66	162
		2.0	4.1	1120	0.043	3.8	0.0023	73	174

16

6SC7#  
12SC7#

See Circuit Diagram 4

90	0.1	0.1	—	1850*	—	—	0.028	4.1	13●
		0.25	—	1960*	—	—	0.012	5.9	23■
		0.5	—	2050*	—	—	0.0065	6.9	25★
	0.25	0.25	—	3400*	—	—	0.011	6.2	26★
		0.5	—	3750*	—	—	0.006	8.6	30
		1.0	—	3900*	—	—	0.003	10	33
	0.5	0.5	—	5500*	—	—	0.005	7.4	31
		1.0	—	6300*	—	—	0.003	10	33
		2.0	—	7450*	—	—	0.0015	12	36
180	0.1	0.1	—	960*	—	—	0.031	17	25
		0.25	—	1070*	—	—	0.012	24	29
		0.5	—	1220*	—	—	0.0065	27	33
	0.25	0.25	—	1850*	—	—	0.011	21	35
		0.5	—	2150*	—	—	0.006	28	39
		1.0	—	2400*	—	—	0.003	32	41
	0.5	0.5	—	3050*	—	—	0.006	24	40
		1.0	—	3420*	—	—	0.003	32	43
		2.0	—	3890*	—	—	0.002	36	45
300	0.1	0.1	—	750*	—	—	0.033	35	29
		0.25	—	930*	—	—	0.014	50	34
		0.25	—	1040*	—	—	0.007	54	36
	0.25	0.25	—	1400*	—	—	0.012	45	39
		0.5	—	1680*	—	—	0.006	55	42
		1.0	—	1840*	—	—	0.003	64	45
	0.5	0.5	—	2330*	—	—	0.006	50	45
		1.0	—	2980*	—	—	0.003	62	48
		2.0	—	3280*	—	—	0.002	72	49

●— At 2 volts (rms) output. ■ At 3 volts (rms) output. ★ At 4 volts (rms) output.

# The cathodes of the two units have a common terminal.

\* Values are for phase-inverter service.

# RCA Receiving Tube Manual

(See page 307 for explanation of column headings)

Ebb	R <sub>p</sub>	R <sub>g</sub>	R <sub>g2</sub>	R <sub>k</sub>	C <sub>g2</sub>	C <sub>k</sub>	C	E <sub>o</sub>	V.G.
90	0.1	0.1	—	4400	—	2.5	0.02	4	28☉
		0.25	—	4800	—	2.1	0.01	5	34■
		0.5	—	5000	—	1.8	0.005	6	35★
	0.25	0.25	—	8000	—	1.33	0.01	6	39■
		0.5	—	8800	—	1.18	0.005	7	43★
		1.0	—	9000	—	0.9	0.003	10	44
	0.5	0.5	—	12200	—	0.76	0.005	8	43
		1.0	—	13500	—	0.67	0.003	10	46
		2.0	—	14700	—	0.58	0.0015	12	48
180	0.1	0.1	—	1800	—	4.4	0.025	16	37
		0.25	—	2000	—	3.3	0.015	23	44
		0.5	—	2200	—	2.9	0.006	25	46
	0.25	0.25	—	3500	—	2.3	0.01	21	48
		0.5	—	4100	—	1.8	0.006	26	53
		1.0	—	4500	—	1.7	0.004	32	57
	0.5	0.5	—	6100	—	1.3	0.006	24	53
		1.0	—	6900	—	0.9	0.003	33	63
		2.0	—	7700	—	0.83	0.0015	37	66
300	0.1	0.1	—	1300	—	5.0	0.025	33	42
		0.25	—	1600	—	3.7	0.01	43	49
		0.5	—	1700	—	3.2	0.006	48	52
	0.25	0.25	—	2600	—	2.5	0.01	41	56
		0.5	—	3200	—	2.1	0.007	54	63
		1.0	—	3500	—	2.0	0.004	63	67
	0.5	0.5	—	4500	—	1.5	0.006	50	65
		1.0	—	5400	—	1.2	0.004	62	70
		2.0	—	6100	—	0.93	0.002	70	70
90	0.1	0.1	0.26	1500	0.11	4.8	0.02	21	21
		0.22	0.3	1600	0.1	4.4	0.012	26	29
		0.47	0.35	1900	0.09	4.2	0.006	28	37
	0.22	0.22	0.64	2400	0.09	3.4	0.009	21	33
		0.47	0.7	2500	0.09	3.2	0.0055	26	40
		1.0	0.84	2600	0.084	3.0	0.0035	29	52
	0.47	0.47	1.5	4200	0.06	2.1	0.0045	21	50
		1.0	1.6	4400	0.06	1.9	0.003	26	59
		2.2	1.7	4800	0.058	1.6	0.002	29	64
180	0.1	0.1	0.33	1000	0.13	6.7	0.02	32	33
		0.22	0.5	1200	0.12	5.8	0.011	37	45
		0.47	0.6	1300	0.11	5.5	0.006	43	52
	0.22	0.22	0.76	1700	0.11	4.5	0.0095	37	47
		0.47	0.9	1700	0.1	4.5	0.0055	44	68
		1.0	1.0	1800	0.1	4.2	0.003	47	82
	0.47	0.47	1.8	3300	0.09	2.9	0.0045	38	70
		1.0	2.0	3800	0.08	2.4	0.003	50	85
		2.2	2.1	4000	0.07	2.3	0.002	57	98
300	0.1	0.1	0.32	750	0.19	8.0	0.021	62	39
		0.22	0.36	850	0.18	7.7	0.012	80	46
		0.47	0.37	900	0.18	7.7	0.006	93	57
	0.22	0.22	0.8	1150	0.13	6	0.01	63	62
		0.47	0.94	1300	0.12	5.7	0.0055	78	88
		1.0	0.98	1500	0.11	5.0	0.0035	99	97
	0.47	0.47	1.7	2300	0.1	3.5	0.0045	71	82
		1.0	1.9	2500	0.1	3.5	0.003	89	109
		2.2	2.0	2800	0.09	3.1	0.002	105	125

17

**6F5  
6F5-GT  
6SF5  
6SF5-GT  
12SF5**

See Circuit  
Diagram 1

18

**6SF7  
12SF7**

See Circuit  
Diagram 3

☉ At 2 volts (rms) output. ■ At 3 volts (rms) output. ★ At 4 volts (rms) output.

# RCA Receiving Tube Manual

(See page 307 for explanation of column headings)

19

**6SJ7  
6SJ7-GT  
12SJ7**

See Circuit  
Diagram 3

Ebb	R <sub>p</sub>	R <sub>g</sub>	R <sub>g2</sub>	R <sub>k</sub>	C <sub>g2</sub>	C <sub>k</sub>	C	E <sub>o</sub>	V.G.
90	0.1	0.1	0.29	820	0.09	8.8	0.02	18	41
		0.25	0.29	880	0.085	7.4	0.016	23	68
		0.5	0.31	1000	0.075	6.6	0.007	28	70
	0.25	0.25	0.69	1680	0.06	5.0	0.012	16	75
		0.5	0.92	1700	0.045	4.5	0.005	18	93
		1.0	0.82	1800	0.04	4.0	0.003	22	104
0.5	0.5	1.5	3600	0.045	2.4	0.003	18	91	
	1.0	1.7	3800	0.03	2.4	0.002	22	119	
	2.0	1.9	4050	0.028	2.35	0.0015	24	139	
180	0.1	0.1	0.29	760	0.10	9.1	0.019	49	55
		0.25	0.31	800	0.09	8.0	0.015	60	82
		0.5	0.37	860	0.09	7.8	0.007	62	91
	0.25	0.25	0.83	1050	0.06	6.8	0.001	38	109
		0.5	0.94	1060	0.06	6.6	0.004	47	131
		1.0	0.94	1100	0.07	6.1	0.003	54	161
0.5	0.5	1.85	2000	0.05	4.0	0.003	37	151	
	1.0	2.2	2180	0.04	3.8	0.002	44	192	
	2.0	2.4	2410	0.035	3.6	0.0015	54	208	
300	0.1	0.1	0.35	500	0.10	11.6	0.019	72	67
		0.25	0.37	530	0.09	10.9	0.016	96	98
		0.5	0.47	590	0.09	9.9	0.007	101	104
	0.25	0.25	0.89	850	0.07	8.5	0.011	79	139
		0.5	1.10	860	0.06	7.4	0.004	88	167
		1.0	1.18	910	0.06	6.9	0.003	98	185
0.5	0.5	2.0	1300	0.06	6.0	0.004	64	200	
	1.0	2.2	1410	0.05	5.8	0.002	79	238	
	2.0	2.5	1530	0.04	5.2	0.0015	89	263	

20

**3AV6  
6AV6  
12AV6  
12AX7\***

See Circuit  
Diagram 1

90	0.1	0.1	-	4400	-	2.7	0.023	5	29●
		0.22	-	4700	-	2.4	0.013	6	35●
		0.47	-	4800	-	2.3	0.007	8	41●
	0.22	0.22	-	7000	-	1.6	0.001	6	39●
		0.47	-	7400	-	1.4	0.006	9	45■
		1.0	-	7600	-	1.3	0.003	11	48★
0.47	0.47	-	12000	-	0.9	0.006	9	48■	
	1.0	-	13000	-	0.8	0.003	11	52★	
	2.2	-	14000	-	0.7	0.002	13	55★	
180	0.1	0.1	-	1800	-	4.0	0.025	18	40
		0.22	-	2000	-	3.5	0.013	25	47
		0.47	-	2200	-	3.1	0.006	32	52
	0.22	0.22	-	3000	-	2.4	0.012	24	53
		0.47	-	3500	-	2.1	0.006	34	59
		1.0	-	3900	-	1.8	0.003	39	63
0.47	0.47	-	5800	-	1.3	0.006	30	62	
	1.0	-	6700	-	1.1	0.003	39	66	
	2.2	-	7400	-	1.0	0.002	45	68	
300	0.1	0.1	-	1300	-	4.6	0.027	43	45
		0.22	-	1500	-	4.0	0.013	57	52
		0.47	-	1700	-	3.6	0.006	66	57
	0.22	0.22	-	2200	-	3.0	0.013	54	59
		0.47	-	2800	-	2.3	0.006	69	65
		1.0	-	3100	-	2.1	0.003	79	68
0.47	0.47	-	4300	-	1.6	0.006	62	69	
	1.0	-	5200	-	1.3	0.003	77	73	
	2.2	-	5900	-	1.1	0.002	92	75	

● At 2 volts (rms) output. ■ At 3 volts (rms) output. ★ At 4 volts (rms) output.  
● One triode unit.



# Circuits

The circuits shown in the following pages are included in this Manual to illustrate some of the more important applications of RCA receiving tubes; they are not necessarily examples of commercial practice. These circuits have been conservatively designed and are capable of excellent performance. Electrical specifications are given for circuit components to assist those interested in home construction. Layouts and mechanical details are omitted because they vary widely with the requirements of individual set builders and with the sizes and shapes of the components employed.

Performance of these circuits depends as much on the quality of the components selected and the care employed in layout and construction as on the circuits themselves. Good signal reproduction from receivers and amplifiers requires the use of good-quality speakers, transformers, chokes, and input sources (microphones, phonograph pickups, etc.).

Coils for the receiver circuits may be purchased at local parts dealers by specifying the characteristics required: for rf coils, the circuit position (antenna or interstage), tuning range desired, and tuning capacitances employed; for if coils or transformers, the intermediate frequency, circuit position (1st if, 2nd if, etc.), and, in some cases, the associ-

ated tube types; for oscillator coils, the receiver tuning range, intermediate frequency, type of converter tube, and type of winding (tapped or transformer-coupled).

The voltage ratings specified for capacitors are the minimum dc working voltages required. Paper, mica, or ceramic capacitors having higher voltage ratings than those specified may be used except insofar as the physical sizes of such capacitors may affect equipment layout. However, if electrolytic capacitors having substantially higher voltage ratings than those specified are used, they may not "form" completely at the operating voltage, with the result that the effective capacitances of such units may be below their rated value. The wattage ratings specified for resistors assume methods of construction that provide adequate ventilation; compact installations having poor ventilation may require resistors of higher wattage ratings.

Information on the characteristics and application features of each tube will be found in the TUBE TYPES SECTION. This information will prove of assistance in understanding and utilizing the circuits.

The following circuits will be found in the subsequent pages:

	<i>Circuit No.</i>
Portable Battery-Operated Superheterodyne Receiver . . . . .	18-1
Portable 3-Way Superheterodyne Receiver . . . . .	18-2
AC-Operated Superheterodyne Receiver . . . . .	18-3
AC/DC Superheterodyne Receiver . . . . .	18-4
Automobile Receiver . . . . .	18-5
Superregenerative Receiver . . . . .	18-6
Battery-Operated Short-Wave Receiver . . . . .	18-7
TRF AM Tuner for High-Fidelity Local Broadcast Reception . . . . .	18-8
FM Tuner . . . . .	18-9
Microphone and Phonograph Amplifier (6 watts) . . . . .	18-10
High-Fidelity Audio Amplifier, Class AB <sub>1</sub> (10 watts) . . . . .	18-11
High-Power Audio Amplifier, Class AB <sub>1</sub> (25 watts) . . . . .	18-12
Class B Amplifier for Mobile Use (10 watts) . . . . .	18-13
Two-Channel Audio Mixer . . . . .	18-14
Preamplifier for Magnetic Phonograph Pickup . . . . .	18-15
Low-Distortion Input Stage . . . . .	18-16
Two-Stage Input Amplifier, Cathode-Follower (Low-Impedance) Output . . . . .	18-17
Bass and Treble Tone-Control Amplifier Stage . . . . .	18-18
Non-Motorboating Resistance-Coupled Amplifier . . . . .	18-19
Code-Practice Oscillator . . . . .	18-20
Intercommunication Set . . . . .	18-21
Electronic Volt-Ohm Meter . . . . .	18-22

(18-1)

## PORTABLE BATTERY-OPERATED SUPERHETERODYNE RECEIVER

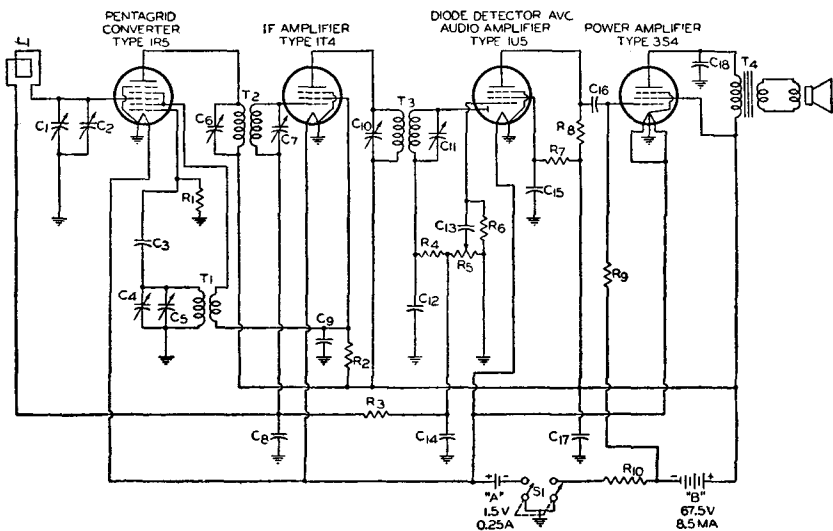

$C_1$   $C_4$  = Ganged tuning capacitors:  $C_1$ , 10-274  $\mu\text{mf}$ ;  $C_4$ , 7.5-122.5  $\mu\text{mf}$   
 $C_2$   $C_5$  = Trimmer capacitors, 2-15  $\mu\text{mf}$   
 $C_3$  = 56  $\mu\text{mf}$ , ceramic  
 $C_6$   $C_7$   $C_{10}$   $C_{11}$  = Trimmer capacitors for if transformers  
 $C_8$  = 0.05  $\mu\text{f}$ , paper, 50 v.  
 $C_9$   $C_{15}$  = 0.02  $\mu\text{f}$ , paper, 100 v.  
 $C_{12}$  = 82  $\mu\text{mf}$ , ceramic  
 $C_{13}$   $C_{16}$  = 0.002  $\mu\text{f}$ , paper, 150 v.  
 $C_{14}$  = 33  $\mu\text{mf}$ , ceramic

$C_{17}$  = 10  $\mu\text{f}$ , electrolytic, 100 v.  
 $C_{18}$  = 0.005  $\mu\text{f}$ , paper, 600 v.  
 $L_1$  = Loop antenna, 540-1600 Kc  
 $R_1$  = 100000 ohms, 0.25 watt  
 $R_2$  = 15000 ohms, 0.25 watt  
 $R_3$   $R_9$  = 3.3 megohms, 0.25 watt  
 $R_4$  = 68000 ohms, 0.25 watt  
 $R_5$  = Volume control, potentiometer, 2 megohms  
 $R_6$  = 10 megohms, 0.25 watt  
 $R_7$  = 4.7 megohms, 0.25 watt  
 $R_8$  = 1 megohm, 0.25 watt

$R_{10}$  = 820 ohms, 0.25 watt  
 $S_1$  = Switch, double-pole, single-throw  
 $T_1$  = Oscillator coil for use with tuning capacitor of 7.5-122.5  $\mu\text{mf}$ , and 455 Kc if transformer  
 $T_2$   $T_3$  = Intermediate-frequency transformers, 455 Kc  
 $T_4$  = Output transformer for matching impedance of voice coil to 5000-ohm tube load

(18-2)

PORTABLE 3-WAY SUPERHETERODYNE RECEIVER

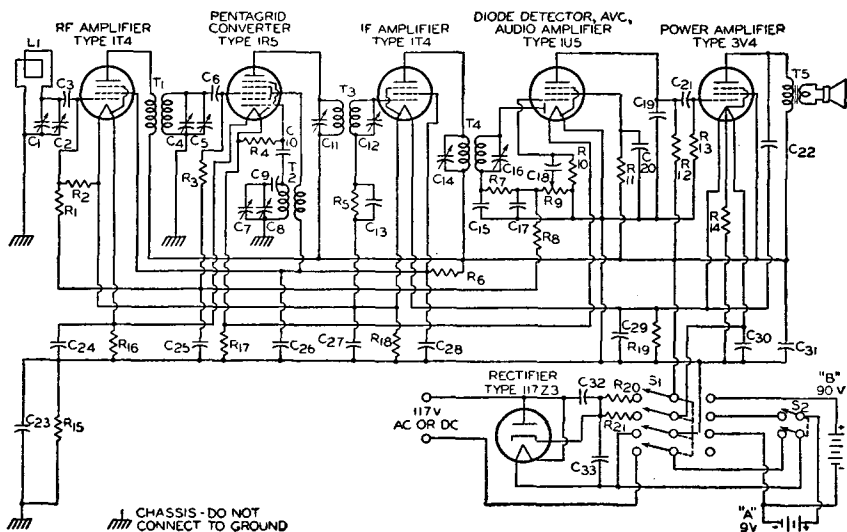

CHASSIS - DO NOT CONNECT TO GROUND

- C<sub>1</sub> C<sub>4</sub> C<sub>8</sub> = Ganged tuning capacitors, 20-450  $\mu\text{f}$
- C<sub>2</sub> C<sub>5</sub> C<sub>7</sub> = Trimmer capacitors, 4-30  $\mu\text{f}$
- C<sub>3</sub> C<sub>10</sub> C<sub>15</sub> C<sub>17</sub> = 100  $\mu\text{f}$ , ceramic
- C<sub>6</sub> = 82  $\mu\text{f}$ , ceramic
- C<sub>9</sub> = 560  $\mu\text{f}$ , ceramic
- C<sub>11</sub> C<sub>12</sub> C<sub>14</sub> C<sub>16</sub> = Trimmer capacitors for if transformers
- C<sub>13</sub> = 0.01  $\mu\text{f}$ , paper, 400 v.
- C<sub>18</sub> C<sub>21</sub> = 0.002  $\mu\text{f}$ , paper, 400 v.
- C<sub>19</sub> = 270  $\mu\text{f}$ , ceramic
- C<sub>20</sub> = 0.02  $\mu\text{f}$ , paper, 400 v.
- C<sub>22</sub> C<sub>22</sub> = 0.005  $\mu\text{f}$ , paper, 400 v.
- C<sub>23</sub> = 0.1  $\mu\text{f}$ , paper, 400 v.
- C<sub>24</sub> = 0.05  $\mu\text{f}$ , paper, 200 v.
- C<sub>25</sub> = 0.05  $\mu\text{f}$ , paper, 50 v.
- C<sub>26</sub> C<sub>27</sub> C<sub>28</sub> = 0.05  $\mu\text{f}$ , paper, 400 v.
- C<sub>29</sub> = 40  $\mu\text{f}$ , electrolytic, 25 v.

- C<sub>30</sub> = 160  $\mu\text{f}$ , electrolytic, 25 v.
- C<sub>31</sub> C<sub>33</sub> = 20  $\mu\text{f}$ , electrolytic, 150 v.
- L<sub>1</sub> = Loop antenna, 540-1600 Kc
- R<sub>1</sub> R<sub>2</sub> R<sub>11</sub> = 4.7 megohms, 0.25 watt
- R<sub>3</sub> = 2.2 megohms, 0.25 watt
- R<sub>4</sub> = 100000 ohms, 0.25 watt
- R<sub>5</sub> = 5.6 megohms, 0.25 watt
- R<sub>6</sub> = 27000 ohms, 0.25 watt
- R<sub>7</sub> = 68000 ohms, 0.25 watt
- R<sub>8</sub> = 3.3 megohms, 0.25 watt
- R<sub>9</sub> = Volume control, potentiometer, 1 megohm
- R<sub>10</sub> = 10 megohms, 0.25 watt
- R<sub>12</sub> = 220000 ohms, 0.25 watt
- R<sub>13</sub> = 1 megohm, 0.25 watt
- R<sub>14</sub> R<sub>16</sub> = 1800 ohms, 0.25 watt
- R<sub>15</sub> = 220000 ohms, 0.5 watt
- R<sub>17</sub> = 1000 ohms, 0.25 watt

- R<sub>18</sub> = 2700 ohms, 0.25 watt
- R<sub>19</sub> = 1500 ohms, 0.25 watt
- R<sub>20</sub> = 1800 ohms, 10 watts
- R<sub>21</sub> = 2300 ohms, 10 watts
- S<sub>1</sub> = Switch, 4-pole double-throw
- S<sub>2</sub> = Switch, double-pole, single-throw
- T<sub>1</sub> = RF transformer, 540-1600 Kc
- T<sub>2</sub> = Oscillator coil for use with a 560- $\mu\text{f}$  padder, 20-450  $\mu\text{f}$  tuning capacitor, and 455 Kc if transformer
- T<sub>3</sub> T<sub>4</sub> = Intermediate-frequency transformers, 455 Kc
- T<sub>5</sub> = Output transformer for matching impedance of voice coil to 10000-ohm tube load

(18-3)

AC-OPERATED SUPERHETERODYNE RECEIVER

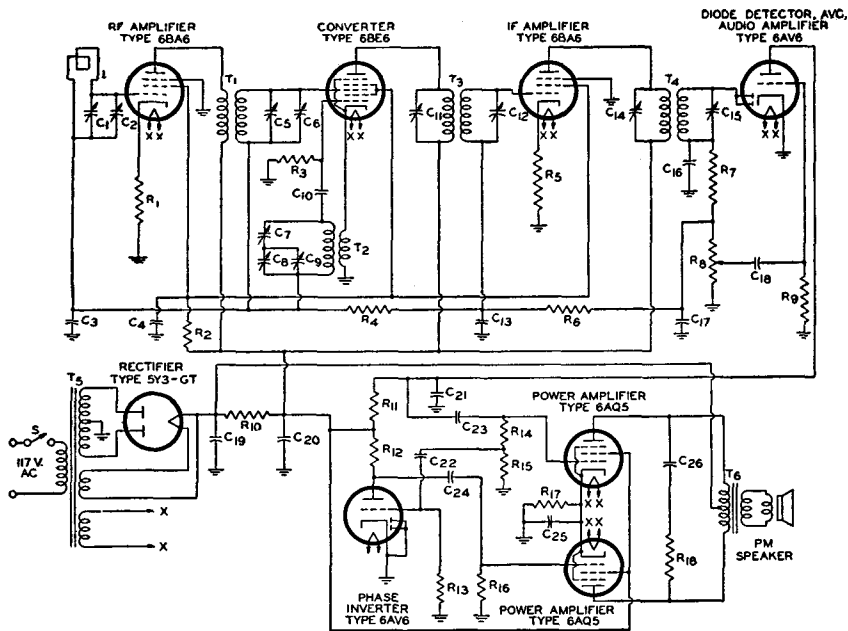

C<sub>1</sub> C<sub>5</sub> C<sub>8</sub>=Ganged tuning capacitors, 10-365  $\mu$ f  
 C<sub>2</sub> C<sub>6</sub> C<sub>9</sub>=Trimmer capacitors, 4-30  $\mu$ f  
 C<sub>3</sub> C<sub>13</sub>=0.05  $\mu$ f, paper, 50 v.  
 C<sub>4</sub>=0.05  $\mu$ f, paper, 400 v.  
 C<sub>7</sub>=Oscillator padding capacitor—follow oscillator-coil manufacturer's recommendation  
 C<sub>10</sub>=56  $\mu$ f, mica  
 C<sub>11</sub> C<sub>12</sub> C<sub>14</sub> C<sub>15</sub>=Trimmer capacitors for if transformers  
 C<sub>16</sub> C<sub>17</sub>=180  $\mu$ f, mica  
 C<sub>18</sub> C<sub>22</sub>=0.01  $\mu$ f, paper, 400 v.  
 C<sub>19</sub> C<sub>20</sub>=20  $\mu$ f, electrolytic, 450 v.

C<sub>21</sub>=120  $\mu$ f, mica  
 C<sub>23</sub> C<sub>24</sub>=0.02  $\mu$ f, paper, 400 v.  
 C<sub>25</sub>=20  $\mu$ f, electrolytic, 50 v.  
 C<sub>26</sub>=0.05  $\mu$ f, paper, 600 v.  
 L=Loop antenna, 540-1600 Kc  
 R<sub>1</sub> R<sub>5</sub>=180 ohms, 0.5 watt  
 R<sub>2</sub>=12000 ohms, 2 watts  
 R<sub>3</sub>=22000 ohms, 0.5 watt  
 R<sub>4</sub> R<sub>6</sub>=2.2 megohms, 0.5 watt  
 R<sub>7</sub>=100000 ohms, 0.5 watt  
 R<sub>8</sub>=Volume control, potentiometer, 1 megohm  
 R<sub>9</sub> R<sub>13</sub>=10 megohms, 0.5 watt  
 R<sub>10</sub>=1800 ohms, 2 watts  
 R<sub>11</sub> R<sub>12</sub>=220000 ohms, 0.5 watt  
 R<sub>14</sub> R<sub>16</sub>=470000 ohms, 0.5 watt  
 R<sub>15</sub>=8200 ohms, 0.5 watt

R<sub>17</sub>=270 ohms, 5 watts  
 R<sub>18</sub>=15000 ohms, 1 watt  
 S=Switch on volume control  
 T<sub>1</sub>=RF transformer, 540-1600 Kc  
 T<sub>2</sub>=Oscillator coil for use with 10-365- $\mu$ f tuning capacitor and 455-Kc if transformer  
 T<sub>3</sub> T<sub>4</sub>=Intermediate-frequency transformers, 455 Kc  
 T<sub>5</sub>=Power transformer, 250-0-250 volts rms, 120 ma. dc  
 T<sub>6</sub>=Output transformer for matching impedance of voice coil to a 10000-ohm plate-to-plate tube load

(18-4)

## AC/DC SUPERHETERODYNE RECEIVER

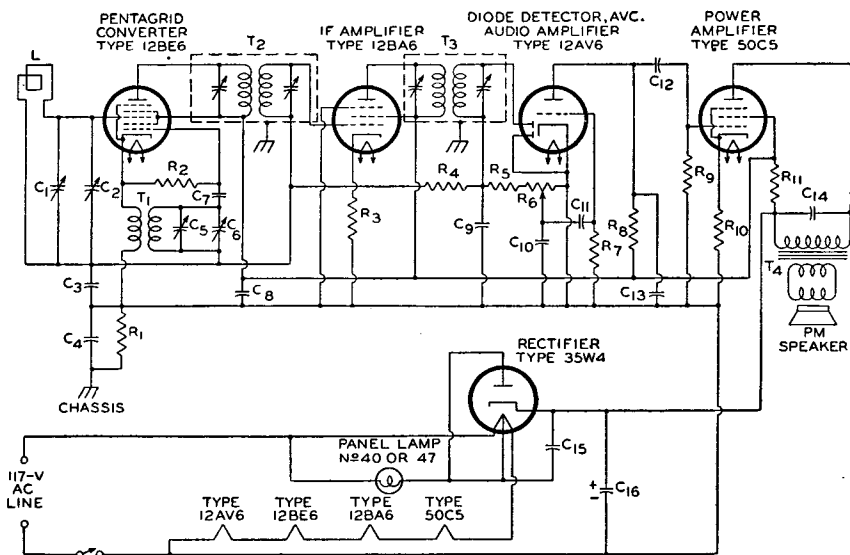

**C<sub>1</sub> C<sub>5</sub>**=Ganged tuning capacitors; **C<sub>1</sub>**, 10-365  $\mu\text{f}$ ; **C<sub>5</sub>**, 7-115  $\mu\text{f}$   
**C<sub>2</sub>**=Trimmer capacitor, 4-30  $\mu\text{f}$   
**C<sub>3</sub>**=0.05  $\mu\text{f}$ , paper, 50 v.  
**C<sub>4</sub>**=0.1  $\mu\text{f}$ , paper, 400 v.  
**C<sub>6</sub>**=Trimmer capacitor, 2-17  $\mu\text{f}$   
**C<sub>7</sub>**=56  $\mu\text{f}$ , ceramic  
**C<sub>8</sub>**=50  $\mu\text{f}$ , electrolytic, 150 v.  
**C<sub>9</sub> C<sub>10</sub>**=150  $\mu\text{f}$ , ceramic  
**C<sub>11</sub> C<sub>14</sub>**=0.02  $\mu\text{f}$ , paper, 400 v.  
**C<sub>12</sub>**=0.002  $\mu\text{f}$ , paper, 400 v.

**C<sub>13</sub>**=330  $\mu\text{f}$ , mica  
**C<sub>15</sub>**=0.05  $\mu\text{f}$ , paper, 400 v.  
**C<sub>16</sub>**=30  $\mu\text{f}$ , electrolytic, 150 v.  
**L**=Loop antenna, 540-1600 Kc  
**R<sub>1</sub> R<sub>3</sub>**=220000 ohms, 0.5 watt  
**R<sub>2</sub>**=22000 ohms, 0.5 watt  
**R<sub>3</sub>**=100 ohms, 0.5 watt  
**R<sub>4</sub>**=3.3 megohms, 0.5 watt  
**R<sub>5</sub>**=47000 ohms, 0.5 watt  
**R<sub>6</sub>**=Volume control, potentiometer, 500000 ohms  
**R<sub>7</sub>**=4.7 megohms, 0.5 watt

**R<sub>9</sub>**=470000 ohms, 0.5 watt  
**R<sub>10</sub>**=150 ohms, 0.5 watt  
**R<sub>11</sub>**=1200 ohms, 1 watt  
**T<sub>1</sub>**=Oscillator coil for use with 7-115- $\mu\text{f}$  tuning capacitor and 455-Kc intermediate-frequency transformer  
**T<sub>2</sub> T<sub>3</sub>**=Intermediate-frequency transformers, 455 Kc  
**T<sub>4</sub>**=Output transformer for matching impedance of voice coil to 2500-ohm tube load

(18-5)

**AUTOMOBILE RECEIVER**

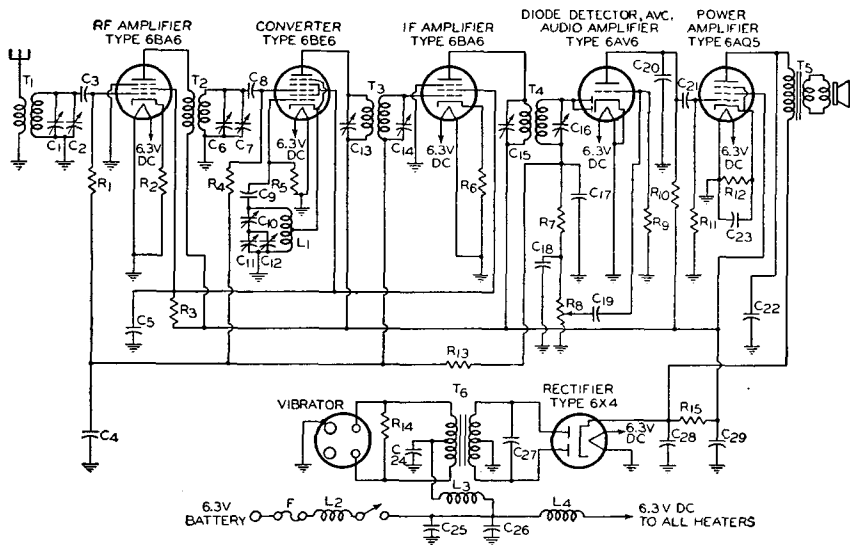

- C<sub>1</sub> C<sub>7</sub> C<sub>11</sub> = Ganged tuning capacitors, 10-365  $\mu$ f
- C<sub>2</sub> C<sub>8</sub> C<sub>12</sub> = Trimmer capacitors, 4-30  $\mu$ f
- C<sub>3</sub> C<sub>9</sub> = 220  $\mu$ f, mica
- C<sub>4</sub> = 0.05  $\mu$ f, paper, 50 v.
- C<sub>5</sub> = 0.05  $\mu$ f, paper, 300 v.
- C<sub>6</sub> = 47  $\mu$ f, mica
- C<sub>10</sub> = Oscillator padding capacitor—follow oscillator coil manufacturer's recommendation
- C<sub>13</sub> C<sub>14</sub> C<sub>15</sub> C<sub>16</sub> = Trimmer capacitors for if transformers
- C<sub>17</sub> C<sub>18</sub> = 100  $\mu$ f, mica
- C<sub>19</sub> = 0.01  $\mu$ f, paper, 300 v.
- C<sub>20</sub> = 120  $\mu$ f, mica
- C<sub>21</sub> = 0.005  $\mu$ f, paper, 300 v.
- C<sub>22</sub> = 0.005  $\mu$ f, paper, 450 v.

- C<sub>23</sub> = 20  $\mu$ f, electrolytic, 25 v.
- C<sub>24</sub> C<sub>26</sub> = 0.5  $\mu$ f, paper, 50 v.
- C<sub>25</sub> = 470  $\mu$ f, mica
- C<sub>27</sub> = 0.006  $\mu$ f, paper, 1500 v.
- C<sub>28</sub> C<sub>29</sub> = 20  $\mu$ f, electrolytic, 450 v.
- F = Fuse, 10 a.
- L<sub>1</sub> = Oscillator coil, tapped, for use with 365- $\mu$ f tuning capacitor, and 455 Kc if transformer
- L<sub>2</sub> L<sub>3</sub> L<sub>4</sub> = RF choke, 10 a.
- R<sub>1</sub> R<sub>4</sub> = 1 megohm, 0.5 watt
- R<sub>2</sub> = 150 ohms, 0.5 watt
- R<sub>3</sub> = 12000 ohms, 2 watts
- R<sub>5</sub> = 22000 ohms, 0.5 watt
- R<sub>6</sub> = 100 ohms, 0.5 watt
- R<sub>7</sub> = 47000 ohms, 0.5 watt
- R<sub>8</sub> = Volume control, potentiometer, 1 megohm

- R<sub>9</sub> = 10 megohms, 0.5 watt
- R<sub>10</sub> = 270000 ohms, 0.5 watt
- R<sub>11</sub> = 470000 ohms, 0.5 watt
- R<sub>12</sub> = 390 ohms, 2 watts
- R<sub>13</sub> = 2.2 megohms, 0.5 watt
- R<sub>14</sub> = 220 ohms, 0.5 watt
- R<sub>15</sub> = 1500 ohms, 1 watt
- T<sub>1</sub> T<sub>2</sub> = RF transformers, 540-1600 Kc
- T<sub>3</sub> T<sub>4</sub> = Intermediate-frequency transformers, 455 Kc
- T<sub>5</sub> = Output transformer for matching impedance of voice coil to 5000-ohm tube load
- T<sub>6</sub> = Vibrator transformer, Stancor P-4062, or equivalent
- Vibrator = Mallory Type No. 859, or equivalent

NOTE: This circuit may be readily adapted for operation from a 12.6-volt dc source by the choice of a suitable vibrator and vibrator transformer, and by the substitution of the following RCA tube types for those shown in the diagram: RF AMPLIFIER, 12BA6; CONVERTER, 12BE6; IF AMPLIFIER, 12BA6; DIODE DETECTOR, AVC, AUDIO AMPLIFIER, 12AV6; POWER AMPLIFIER, 12AQ5; RECTIFIER, 12X4. Recommendations as to suitable vibrators and vibrator transformers may be obtained from manufacturers of these components. For 12.6-volt operation the voltage rating of C<sub>24</sub> and C<sub>25</sub> should be increased to 100 volts.

(18-6)

**SUPERREGENERATIVE RECEIVER**

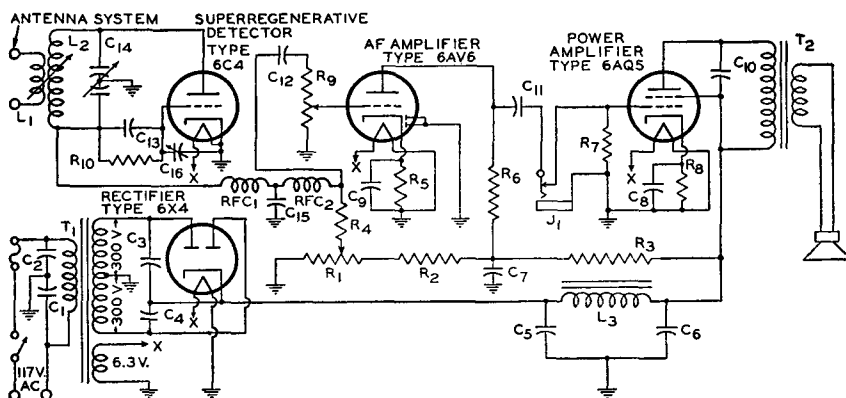

C<sub>1</sub> C<sub>2</sub> = 0.1  $\mu$ f, paper, 400 v.  
 C<sub>3</sub> C<sub>4</sub> = 100  $\mu$ f, mica, 500 v.  
 C<sub>5</sub> C<sub>6</sub> C<sub>7</sub> = 20  $\mu$ f, electrolytic,  
 450 v.  
 C<sub>8</sub> = 25  $\mu$ f, electrolytic, 50 v.  
 C<sub>9</sub> = 25  $\mu$ f, electrolytic, 25 v.  
 C<sub>10</sub> = 0.002  $\mu$ f, paper, 600 v.  
 C<sub>11</sub> = 0.01  $\mu$ f, paper, 400 v.  
 C<sub>12</sub> = 0.005  $\mu$ f, paper, 400 v.  
 C<sub>13</sub> = 50  $\mu$ f, silver mica, 300 v.  
 C<sub>14</sub> = Ganged or split-stator tuning  
 capacitor, 10  $\mu$ f max. per  
 section  
 C<sub>15</sub> = 0.006  $\mu$ f, mica, 300 v.  
 C<sub>16</sub> = Quench-frequency control,

trimmer capacitor, 3-30  $\mu$ f,  
 ceramic or mica  
 J<sub>1</sub> = Jack for earphones  
 L<sub>1</sub> = Antenna pickup winding  
 L<sub>2</sub> = 4 turns of No. 12 Enam. cop-  
 per wire on a 1/2" I.D. form  
 (144 Mc): adjust spacing to  
 set band  
 L<sub>3</sub> = Speaker field or filter choke,  
 12 henries, 70 ma.  
 R<sub>1</sub> = Potentiometer, 50000  
 ohms, 1 watt, wire wound  
 R<sub>2</sub> R<sub>3</sub> = 47000 ohms, 1 watt  
 R<sub>4</sub> = 27000 ohms, 0.5 watt  
 R<sub>5</sub> = 2700 ohms, 1 watt

R<sub>6</sub> R<sub>7</sub> = 100000 ohms, 0.5 watt  
 R<sub>8</sub> = 270 ohms, 1 watt  
 R<sub>9</sub> = Volume control, potenti-  
 ometer, 500000 ohms  
 R<sub>10</sub> = 4.7 megohms, 0.5 watt  
 RFC<sub>1</sub> = One-quarter wavelength  
 (20.5 inches at 144 Mc) of No.  
 23 Enam. close wound on a  
 1/4" form  
 RFC<sub>2</sub> = RF choke, 8 mh.  
 T<sub>1</sub> = Power transformer,  
 300-0-300 volts rms, 70 ma.  
 T<sub>2</sub> = Output transformer for  
 matching impedance of voice  
 coil to 5000-ohm tube load

(18-7)

### BATTERY-OPERATED SHORT-WAVE RECEIVER

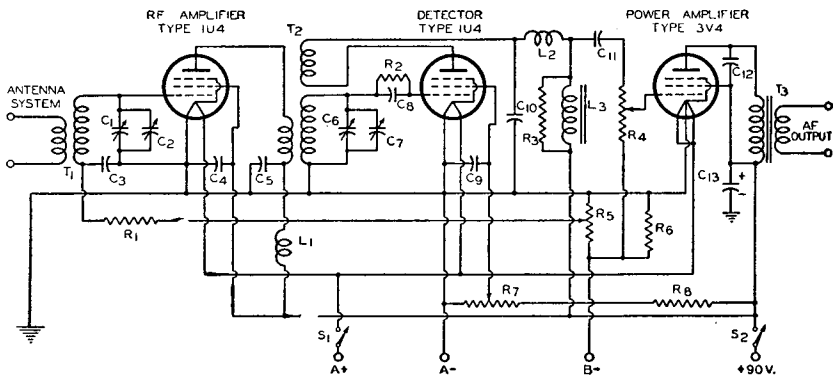

**C<sub>1</sub> C<sub>6</sub>**=Ganged band-setting capacitors, 140  $\mu\mu\text{f}$ , maximum per section  
**C<sub>2</sub> C<sub>7</sub>**=Ganged band-tuning capacitors, 35  $\mu\mu\text{f}$  maximum per section  
**C<sub>3</sub> C<sub>4</sub> C<sub>5</sub> C<sub>11</sub>**=0.05  $\mu\text{f}$   
**C<sub>8</sub> C<sub>10</sub>**=250  $\mu\mu\text{f}$ , mica  
**C<sub>9</sub>**=1  $\mu\text{f}$ , paper, 100 v.  
**C<sub>12</sub>**=0.002 uf, paper, 400 v.  
**C<sub>13</sub>**=8  $\mu\text{f}$ , electrolytic, 150 v.  
**L<sub>1</sub> L<sub>2</sub>** = RF chokes, 8 mh.

**L<sub>3</sub>** = AF choke 300-500 h.  
**R<sub>1</sub>** = 100000 ohms, 0.5 watt  
**R<sub>2</sub>** = 2 - 5 megohm, 0.5 watt  
**R<sub>3</sub>**=270000 ohms, 0.5 watt  
**R<sub>4</sub>** = Volume control, potentiometer, 500000 ohms  
**R<sub>5</sub>**=RF gain control, potentiometer, 50000 ohms  
**R<sub>6</sub>**=470 ohms, 0.5 watt  
**R<sub>7</sub>**=Regeneration control, potentiometer, 50000 ohms  
**R<sub>8</sub>**=33000 ohms, 0.5 watt

**S<sub>1</sub> S<sub>2</sub>** = Ganged switch, double-pole, single-throw  
**T<sub>1</sub>** = RF coil of the 4-prong, 2-winding, plug-in type for use with 140- $\mu\mu\text{f}$  tuning capacitor  
**T<sub>2</sub>** = Regenerative detector coil of the 6-prong, 3-winding plug-in type for use with 140- $\mu\mu\text{f}$  tuning capacitor  
**T<sub>3</sub>** = Output transformer for matching impedance of voice coil to 9000-ohm tube load



(18-8)

### TRF AM TUNER

For High-Fidelity Local Broadcast Reception

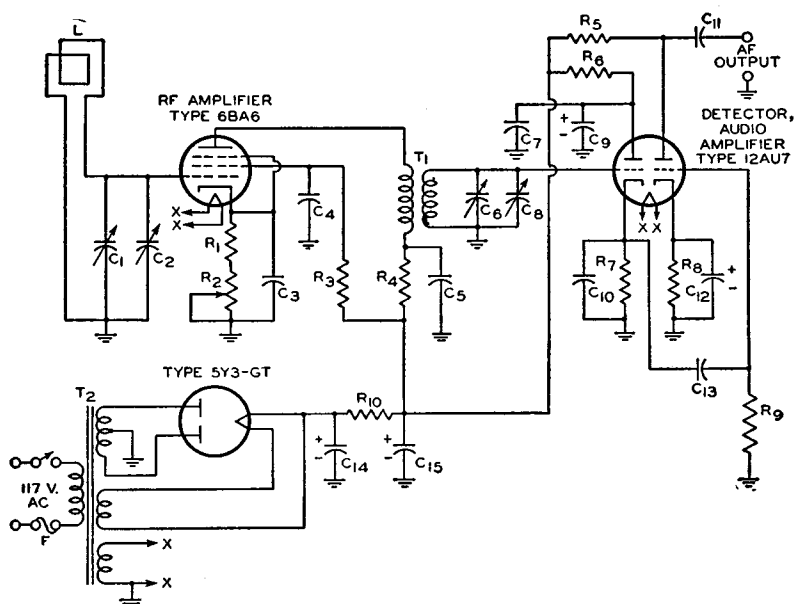

C<sub>1</sub> C<sub>6</sub>=Ganged tuning capacitors, 10-365  $\mu\mu\text{f}$   
 C<sub>2</sub> C<sub>8</sub>=Trimmer capacitors, 4-30  $\mu\mu\text{f}$   
 C<sub>3</sub>=0.01  $\mu\text{f}$ , paper or ceramic, 200 v.  
 C<sub>4</sub>=0.01  $\mu\text{f}$ , paper or ceramic, 400 v.  
 C<sub>5</sub> C<sub>11</sub>=0.1  $\mu\text{f}$ , paper, 400 v.  
 C<sub>7</sub>=250  $\mu\mu\text{f}$ , mica or ceramic, 400 v.

C<sub>9</sub>=10  $\mu\text{f}$ , electrolytic, 350 v.  
 C<sub>10</sub>=250  $\mu\mu\text{f}$ , mica or ceramic, 200 v.  
 C<sub>12</sub>=25  $\mu\text{f}$ , electrolytic, 25 v.  
 C<sub>13</sub>=0.05  $\mu\text{f}$ , paper, 200 v.  
 C<sub>14</sub> C<sub>15</sub>=20  $\mu\text{f}$ , electrolytic, 450 v.  
 F=Fuse, 1 ampere  
 L=Loop antenna, 540-1600 Kc.  
 R<sub>1</sub>=180 ohms, 0.5 watt  
 R<sub>2</sub>=Volume control, potentiometer, 5000 ohms

R<sub>3</sub>=33000 ohms, 1 watt  
 R<sub>4</sub> R<sub>8</sub>=1000 ohms, 0.5 watt  
 R<sub>5</sub>=100000 ohms, 0.5 watt  
 R<sub>7</sub>=150000 ohms, 0.5 watt  
 R<sub>8</sub>=1500 ohms, 0.5 watt  
 R<sub>9</sub>=470000 ohms, 0.5 watt  
 R<sub>10</sub>=7000 ohms, 10 watts  
 T<sub>1</sub>=RF transformer, 540-1600 Kc.  
 T<sub>2</sub>=Power transformer, 250-0-250 volts rms, 40 ma.

(18-9)

FM TUNER

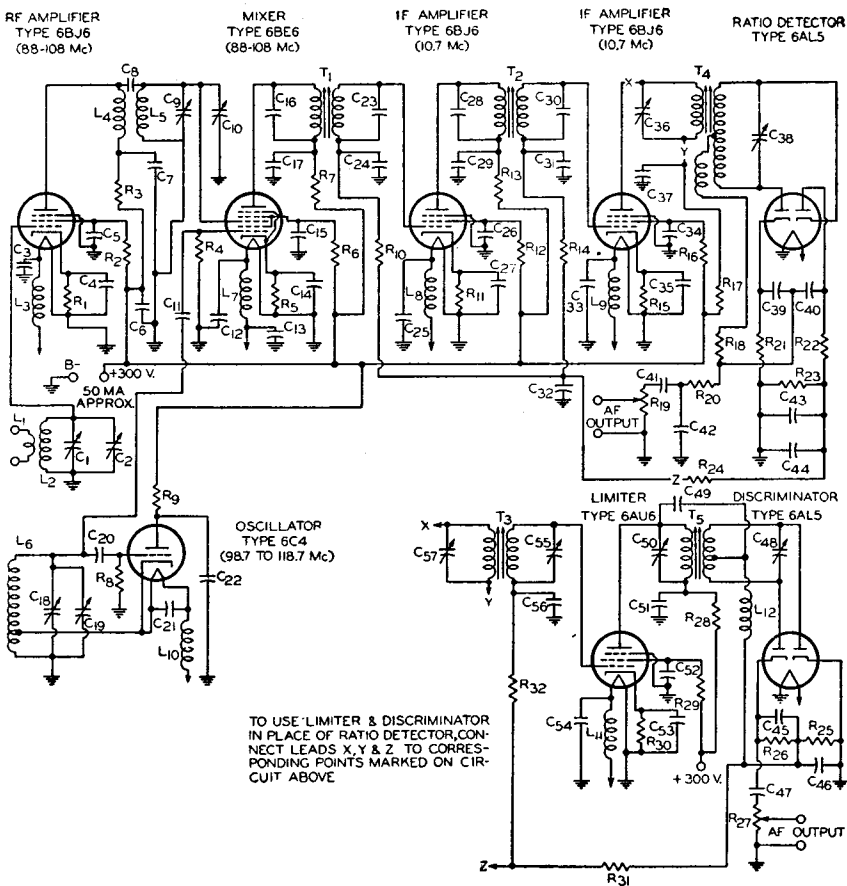

**(18-9)**

**FM TUNER (Cont'd)**

C<sub>1</sub> C<sub>9</sub> C<sub>18</sub> = Ganged tuning capacitors, 7.5 - 20  $\mu\text{mf}$   
 C<sub>2</sub> C<sub>10</sub> C<sub>19</sub> = Trimmer capacitors, 1.5 - 5.0  $\mu\text{mf}$ , ceramic  
 C<sub>3</sub> = 0.01  $\mu\text{f}$ , ceramic or mica, 200 v.  
 C<sub>4</sub> C<sub>14</sub> C<sub>24</sub> C<sub>27</sub> C<sub>31</sub> C<sub>25</sub> C<sub>33</sub> C<sub>36</sub> = 1500  $\mu\text{mf}$ , ceramic or mica, 200 v.  
 C<sub>5</sub> C<sub>7</sub> C<sub>15</sub> C<sub>17</sub> C<sub>22</sub> C<sub>26</sub> C<sub>29</sub> C<sub>34</sub> C<sub>37</sub> C<sub>32</sub> = 1500  $\mu\text{mf}$ , ceramic or mica, 400 v.  
 C<sub>6</sub> = 0.1  $\mu\text{f}$ , paper, 400 v.  
 C<sub>8</sub> = 33  $\mu\text{mf}$ , mica, 400 v.  
 C<sub>11</sub> = 3  $\mu\text{mf}$ , silver mica, 200 v.  
 C<sub>12</sub> C<sub>13</sub> C<sub>25</sub> C<sub>32</sub> C<sub>33</sub> C<sub>34</sub> = 0.01  $\mu\text{f}$ , ceramic or mica, 200 v.  
 C<sub>16</sub> C<sub>23</sub> C<sub>28</sub> C<sub>30</sub> C<sub>35</sub> C<sub>38</sub> C<sub>45</sub> C<sub>49</sub> C<sub>50</sub> C<sub>56</sub> C<sub>57</sub> = Trimmer capacitors, 22-50  $\mu\text{mf}$ , mica, usually part of if transformer  
 C<sub>20</sub> = 33  $\mu\text{mf}$ , silver mica, 200 v.  
 C<sub>21</sub> = 100  $\mu\text{mf}$ , ceramic or mica, 200 v.  
 C<sub>39</sub> C<sub>40</sub> = 330  $\mu\text{mf}$ , ceramic or mica, 200 v.  
 C<sub>41</sub> = 0.05  $\mu\text{f}$ , paper, 200 v.  
 C<sub>42</sub> C<sub>43</sub> = 0.005  $\mu\text{f}$ , ceramic or paper, 200 v.  
 C<sub>44</sub> = 10  $\mu\text{f}$ , electrolytic, 200 v.

C<sub>45</sub> C<sub>46</sub> = 250  $\mu\text{mf}$ , ceramic or mica, 200 v.  
 C<sub>47</sub> = 0.1  $\mu\text{f}$ , paper, 200 v.  
 C<sub>51</sub> = 500  $\mu\text{mf}$ , ceramic or mica, 400 v.  
 L<sub>1</sub> = 1 turn of No.14 Enam. wound on a  $\frac{3}{4}$ " diam. coil form  
 L<sub>2</sub> = 2.5 turns of No.14 Enam. spaced 1 wire diameter wound on same form as L<sub>1</sub> with the ground end of L<sub>2</sub> spaced  $\frac{1}{4}$ " from L<sub>1</sub>  
 L<sub>3</sub> L<sub>4</sub> L<sub>7</sub> L<sub>8</sub> L<sub>9</sub> L<sub>10</sub> L<sub>11</sub> = Choke, 1  $\mu\text{h}$  (approx.), 25 turns of No.24 Enam. close-wound on resistor (47000 ohms, 0.5 watt), connected in parallel with resistor.  
 L<sub>5</sub> = 2.5 turns of No.14 Enam. spaced 1 wire diameter, wound on  $\frac{3}{4}$ " form.  
 L<sub>6</sub> = 2 turns of No.14 Enam. spaced 1 wire diameter, wound on  $\frac{3}{4}$ " form, tapped at  $\frac{1}{2}$  turn from ground end  
 L<sub>12</sub> = Choke, 2.5 mh. (may not be required: follow transformer manufacturer's recommendation)

R<sub>1</sub> R<sub>11</sub> R<sub>15</sub> R<sub>39</sub> = 120 ohms, 0.5 watt  
 R<sub>2</sub> R<sub>12</sub> R<sub>16</sub> = 39000 ohms, 0.5 watt  
 R<sub>3</sub> R<sub>7</sub> R<sub>13</sub> R<sub>17</sub> = 470 ohms, 0.5 watt  
 R<sub>4</sub> R<sub>23</sub> R<sub>25</sub> = 10000 ohms, 0.5 watt  
 R<sub>5</sub> = 47 ohms, 0.5 watt  
 R<sub>6</sub> = 33000 ohms, 1 watt  
 R<sub>8</sub> = 47000 ohms, 0.5 watt  
 R<sub>9</sub> = 4700 ohms, 1 watt  
 R<sub>10</sub> R<sub>14</sub> R<sub>32</sub> = 220000 ohms, 0.5 watt  
 R<sub>18</sub> = 56 ohms, 0.5 watt  
 R<sub>19</sub> R<sub>27</sub> = Volume controls, potentiometers, 1 megohm  
 R<sub>20</sub> = 15000 ohms, 0.5 watt  
 R<sub>21</sub> = 320 ohms, 0.5 watt  
 R<sub>22</sub> = 560 ohms, 0.5 watt  
 R<sub>24</sub> R<sub>31</sub> = 2.2 megohms, 0.5 watt  
 R<sub>26</sub> R<sub>28</sub> = 100000 ohms, 0.5 watt  
 R<sub>29</sub> = 150000 ohms, 1 watt  
 T<sub>1</sub> T<sub>2</sub> T<sub>3</sub> = Intermediate-frequency transformers, 10.7 Mc  
 T<sub>4</sub> = Ratio-detector transformer, 10.7 Mc  
 T<sub>5</sub> = Discriminator transformer, 10.7 Mc

NOTE: A high-frequency de-emphasis network having a time constant of 75 microseconds (such as that formed by R<sub>20</sub> and C<sub>42</sub>) should be inserted between R<sub>26</sub> and C<sub>47</sub> in the discriminator output lead.

Fig. 18-9 illustrates a circuit for an FM broadcast tuner. The basic circuit has been arranged to show the use of a ratio detector, but the limiter/discriminator circuit shown in the lower right-hand corner of the diagram can be substituted as indicated at points X, Y, and Z in the schematic.

A word of caution is necessary in connection with this circuit. Because it works at very high frequencies and is required to handle a very wide bandwidth, its construction requires more than ordinary skill and experience. Placement of component parts is quite critical and may require considerable experimentation. All rf leads to components including bypass capacitors must be kept short and must be properly dressed to minimize undesirable coupling and capacitance effects. Correct circuit alignment and oscillator tracking require the use of a cathode-ray oscilloscope, a high-impedance vacuum-tube voltmeter, and a signal generator capable of supplying a frequency-modulated signal on 10.7 Mc as well as accurate marker signals in the 88-108-Mc band. Unless the builder has the necessary equipment and has had considerable experience with broad-band, high-frequency circuits, he should not undertake the construction of this circuit.

(18-10)

## MICROPHONE AND PHONOGRAPH AMPLIFIER

Power Output, 6 Watts

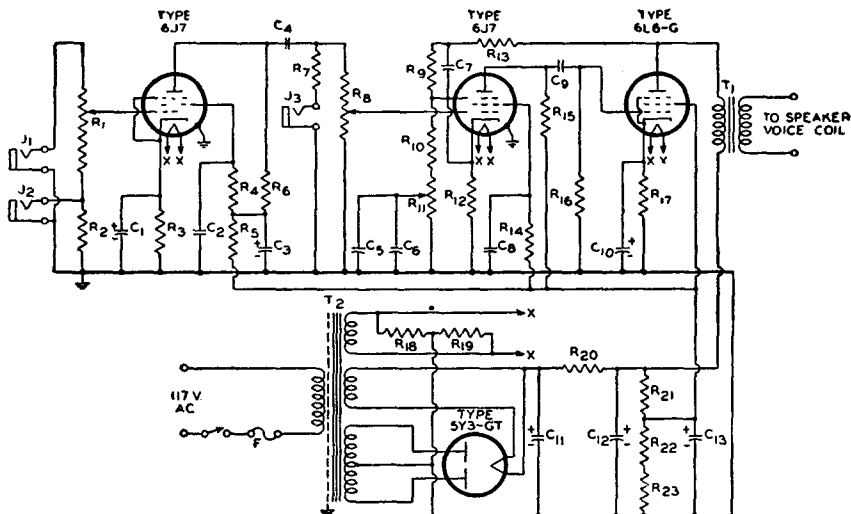

**C<sub>1</sub>** = 16  $\mu$ f, electrolytic, 150 v.  
**C<sub>2</sub>** **C<sub>3</sub>** = 0.1  $\mu$ f, paper, 400 v.  
**C<sub>3</sub>** **C<sub>13</sub>** = 10  $\mu$ f, electrolytic, 450 v.  
**C<sub>4</sub>** **C<sub>9</sub>** = 0.05  $\mu$ f, paper, 400 v.  
**C<sub>5</sub>** = 0.1  $\mu$ f, paper, 200 v.  
**C<sub>6</sub>** = 0.25  $\mu$ f, paper, 200 v.  
**C<sub>7</sub>** = 820  $\mu$ f, mica, 500 v.  
**C<sub>10</sub>** = 20  $\mu$ f, electrolytic, 25 v.  
**C<sub>11</sub>** **C<sub>12</sub>** = 25  $\mu$ f, electrolytic, 450 v.  
**F** = Fuse, 1 ampere  
**J<sub>1</sub>** = Jack for high-impedance crystal microphone input, maximum input: 2 volts peak  
**J<sub>2</sub>** = Jack for low-impedance

phono-pickup input, maximum input: 0.135 volt peak  
**J<sub>3</sub>** = Jack for high-impedance phono-pick up input, maximum input: 20 volts peak  
**R<sub>1</sub>** **R<sub>8</sub>** = Volume control, potentiometer, 500000 ohms  
**R<sub>2</sub>** = 2200 ohms, 0.5 watt  
**R<sub>4</sub>** = 1500 ohms, 0.5 watt  
**R<sub>4</sub>** **R<sub>14</sub>** = 1.2 megohms, 0.5 watt  
**R<sub>5</sub>** **R<sub>13</sub>** = 82000 ohms, 0.5 watt  
**R<sub>6</sub>** = 270000 ohms, 0.5 watt  
**R<sub>7</sub>** **R<sub>9</sub>** = 470000 ohms, 0.5 watt  
**R<sub>10</sub>** = 47 ohms, 0.5 watt

**R<sub>11</sub>** = Tone control, potentiometer, 5000 ohms  
**R<sub>12</sub>** = 1000 ohms, 0.5 watt  
**R<sub>15</sub>** = 220000 ohms, 0.5 watt  
**R<sub>16</sub>** = 330000 ohms, 0.5 watt  
**R<sub>17</sub>** = 220 ohms, 2 watts  
**R<sub>18</sub>** **R<sub>19</sub>** = 33 ohms, 0.5 watt  
**R<sub>20</sub>** = 440 ohms, 10 watts  
**R<sub>21</sub>** = 8200 ohms, 0.5 watt  
**R<sub>22</sub>** **R<sub>23</sub>** = 33000 ohms, 2 watts  
**T<sub>1</sub>** = Output transformer for matching impedance of voice coil to 4000-ohm tube load  
**T<sub>2</sub>** = Power transformer, 350-0-350 volts rms, 125 ma.

(18-11)

### HIGH-FIDELITY AUDIO AMPLIFIER

Class AB<sub>1</sub>; Output, 10 Watts

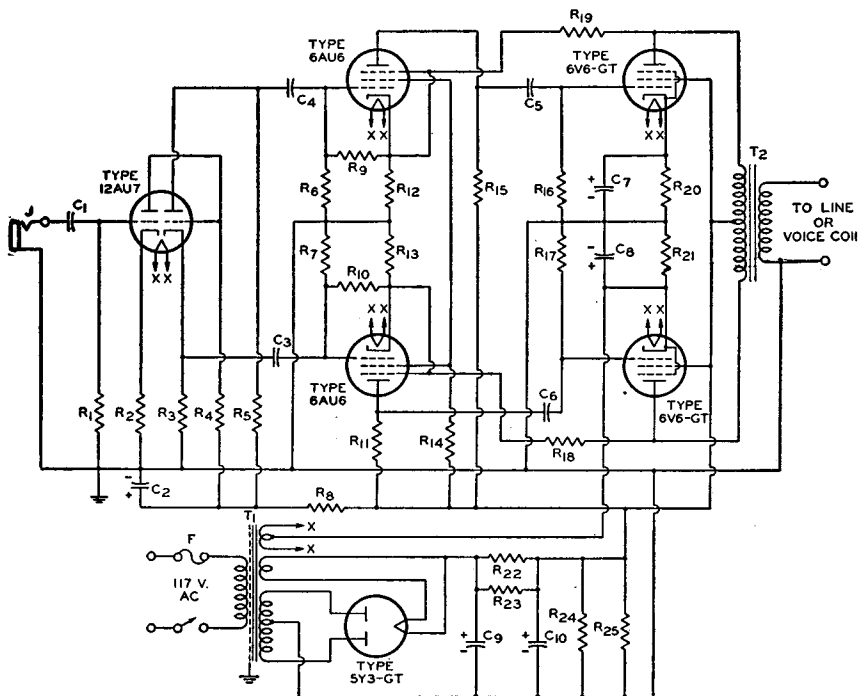

$C_1=0.1 \mu\text{f}$ , paper, 600 v.  
 $C_2=40 \mu\text{f}$ , electrolytic, 450 v.  
 $C_3, C_4=0.02 \mu\text{f}$ , paper, 600 v.  
 $C_5, C_6=0.05 \mu\text{f}$ , paper, 600 v.  
 $C_7, C_8=50 \mu\text{f}$ , electrolytic, 50 v.  
 $C_9, C_{10}=80 \mu\text{f}$ , electrolytic, 450 v.  
 F=Fuse, 1 ampere  
 $R_1=470000$  ohms, 0.5 watt  
 $R_2=6800$  ohms, 0.5 watt  
 $R_3, R_4=39000$  ohms  $\pm 1$  per cent,

matched, 1 watt  
 $R_5, R_6, R_7, R_{14}=1$  megohm, 0.5 watt  
 $R_8=10000$  ohms, 1 watt  
 $R_9, R_{10}, R_{11}, R_{15}, R_{16}, R_{17}=330000$   
 ohms, 0.5 watt  
 $R_{12}, R_{13}=1800$  ohms  $\pm 1$  per cent,  
 matched, 0.5 watt  
 $R_{18}, R_{19}$ =Carbon-film type,  
 100000 ohms  $\pm 1$  per cent,

matched, 2 watts  
 $R_{20}, R_{21}=510$  ohms, 2 watts  
 $R_{22}, R_{23}=390$  ohms, 2 watts  
 $R_{24}, R_{25}=150000$  ohms, 2 watts  
 $T_1$ =Power transformer,  
 350-0-350 volts rms, 125 ma.  
 $T_2$ =Output transformer for  
 matching line or voice coil im-  
 pedance to 9000-10000-ohm  
 plate-to-plate tube load

(18-12)

## HIGH-POWER AUDIO AMPLIFIER

Class AB<sub>1</sub>; Output, 25 Watts

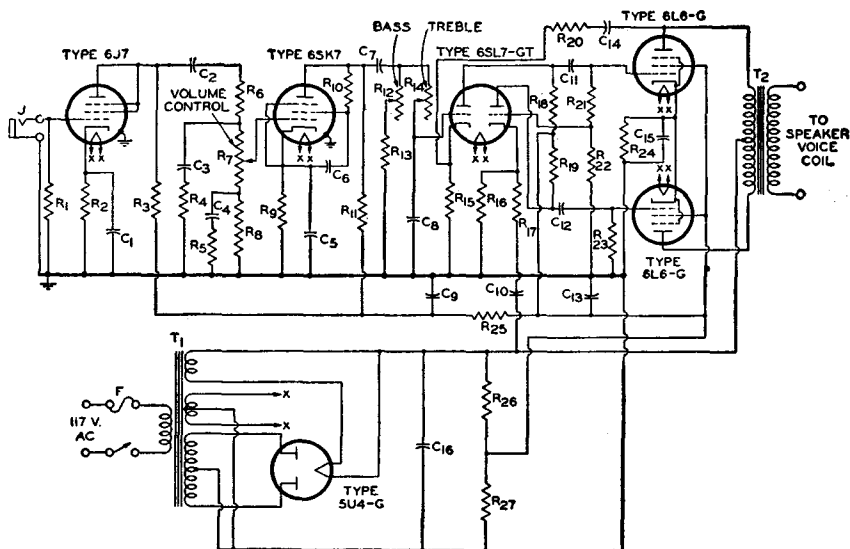

$C_1$   $C_2$   $C_{13}$  = 20  $\mu$ f, electrolytic, 25 v.  
 $C_3$   $C_4$   $C_7$  = 0.01  $\mu$ f, paper, 600 v.  
 $C_4$  = 0.005  $\mu$ f, paper, 100 v.  
 $C_5$  = 0.5  $\mu$ f, paper, 600 v.  
 $C_8$  = 330  $\mu$ f, mica  
 $C_9$   $C_{12}$  = 30  $\mu$ f, electrolytic, 450 v.  
 $C_{10}$   $C_{11}$   $C_{12}$   $C_{14}$  = 0.1  $\mu$ f, paper, 600 v.  
 $C_{16}$  = 40  $\mu$ f, electrolytic, 450 v.  
 F = Fuse, 3 amperes  
 J = Jack for high-impedance phono-pickup input  
 $R_1$  = 1 megohm, 0.5 watt  
 $R_2$  = 1800 ohms, 0.5 watt

$R_3$   $R_4$  = 82000 ohms, 0.5 watt  
 $R_5$   $R_{13}$  = 47000 ohms, 0.5 watt  
 $R_6$   $R_7$   $R_8$  = Volume control, potentiometer, 1.5 megohm, tapped at 250000 and 500000 ohms.  $R_8$  is 250000-ohm section.  
 $R_9$  = 390 ohms, 0.5 watt  
 $R_{10}$  = 120000 ohms, 0.5 watt  
 $R_{11}$  = 15000 ohms, 0.5 watt  
 $R_{12}$  = Bass control, potentiometer, 500000 ohms  
 $R_{14}$  = Treble control, potentiometer 500000 ohms,  
 $R_{15}$   $R_{16}$  = 4700 ohms, 0.5 watt

$R_{17}$  = 250000 ohms, 0.5 watt  
 $R_{18}$   $R_{19}$  = 220000 ohms, 1 watt  
 $R_{20}$  = 560000 ohms, 0.5 watt  
 $R_{21}$   $R_{23}$  = 270000 ohms, 0.5 watt  
 $R_{22}$  = 12000 ohms, 0.5 watt  
 $R_{24}$  = 185 ohms, 10 watts  
 $R_{25}$  = 10000 ohms, 1 watt  
 $R_{26}$  = 2000 ohms, 20 watts  
 $R_{27}$  = 12500 ohms, 20 watts  
 $T_1$  = Power transformer, 400-0-400 volts rms, 200 ma.  
 $T_2$  = Output transformer for matching impedance of voice coil to 6600-ohm plate-to-plate tube load

NOTE: The value of  $R_{17}$  should be adjusted for minimum power-supply ripple in output.

(18-13)

### CLASS B AMPLIFIER FOR MOBILE USE

Power Output 10 Watts\*

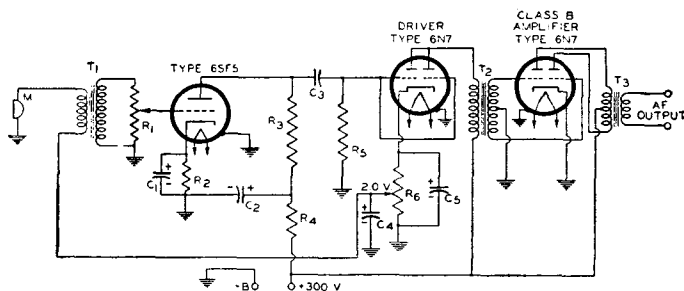

$C_1 = 5 \mu\text{f}$ , electrolytic, 25 v.  
 $C_2 = 4 \mu\text{f}$ , electrolytic, 250 v.  
 $C_3 = 0.025 \mu\text{f}$ , paper, 400 v.  
 $C_4 = 25 \mu\text{f}$ , electrolytic, 25 v.  
 $C_5 = 50 \mu\text{f}$ , electrolytic, 25 v.  
 M = Microphone, single-button carbon, 200 ohms  
 $R_1$  = Volume control, potentiometer, 500000 ohms

$R_2 = 1300$  ohms, 0.5 watt  
 $R_3, R_4 = 100000$  ohms, 0.5 watt  
 $R_5 = 47000$  ohms, 0.5 watt  
 $R_6$  = Voltage control, variable resistor, 1000 ohms, set for 2.0 volts  
 $T_1$  = Transformer for matching a single-button microphone to a single grid

$T_2$  = Input transformer for matching parallel-connected 6N7 driver to a 6N7 class B amplifier  
 $T_3$  = Output transformer for matching impedance of voice coil to 8000-ohm plate-to-plate tube load

\* Peak signal-input voltage to 6SF5 grid required for full power output is 0.15 volt.

(18-14)

### TWO-CHANNEL AUDIO MIXER

Voltage Gain From Each Grid of 6SC7 to Output is Approximately 15

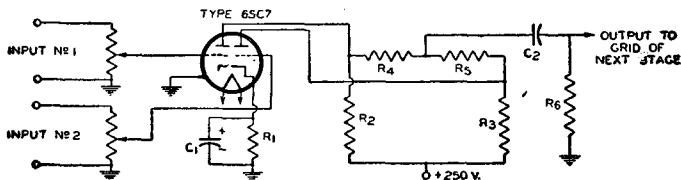

$C_1 = 10 \mu\text{f}$ , electrolytic, 25 v.  
 $C_2 = 0.005 \mu\text{f}$ , paper, 400 v.

$R_1 = 2200$  ohms, 0.5 watt

$R_2, R_3 = 270000$  ohms, 0.5 watt  
 $R_4, R_5, R_6 = 1$  megohm, 0.5 watt

(18-15)

**PREAMPLIFIER FOR MAGNETIC PHONOGRAPH PICKUP**

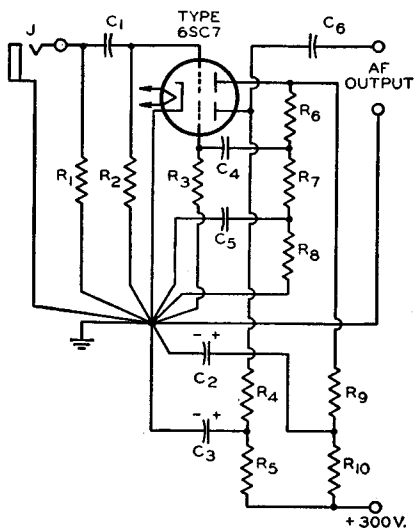

$C_1 C_4 C_6=0.05 \mu\text{f}$ , paper, 600 v.  
 $C_2 C_3=20 \mu\text{f}$ , electrolytic, 450 v.  
 $C_5=0.01 \mu\text{f}$ , paper, 600 v.  
**J**=Input connector, shielded.

$R_1$ =Value depends on type of magnetic pickup used. Follow pickup manufacturer's recommendations  
 $R_2 R_3=3.3$  megohms, 0.5 watt

$R_4 R_5=33000$  ohms, 0.5 watt  
 $R_6=200000$  ohms, 0.5 watt  
 $R_7=27000$  ohms, 0.5 watt  
 $R_8=180000$  ohms, 0.5 watt  
 $R_9 R_{10}=6800$  ohms, 0.5 watt

(18-16)

**LOW-DISTORTION INPUT AMPLIFIER STAGE**

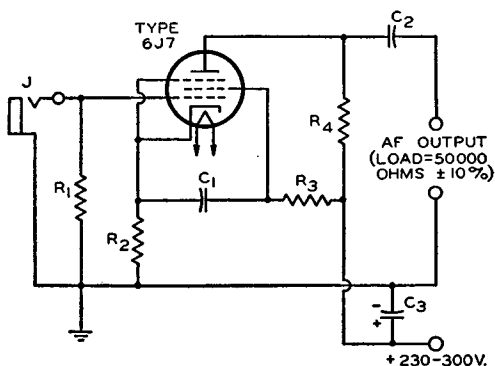

$C_1=0.25 \mu\text{f}$ , paper, oil-filled, 600 v.  
 $C_2=0.5 \mu\text{f}$ , paper, oil-filled, 600 v.  
 $C_3=40 \mu\text{f}$ , electrolytic, 350 v.

**J**=Input connector, shielded  
 $R_1=50000$  to  $100000$  ohms to match source impedance, 0.5 watt  
 $R_2=910$  ohms  $\pm 5$  per cent, 0.5

watt, wire-wound  
 $R_3=270000$  ohms  $\pm 5$  per cent, 0.5 watt  
 $R_4=100000$  ohms  $\pm 5$  per cent, 0.5 watt



(18-17)

### TWO-STAGE INPUT AMPLIFIER Cathode-Follower (Low-Impedance) Output

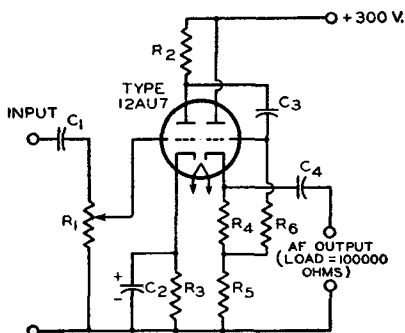

$C_1$   $C_3$  = 0.1  $\mu$ f, paper, 400 v.  
 $C_2$  = 25  $\mu$ f, electrolytic, 25 v.  
 $C_4$  = 5  $\mu$ f, paper, 200 v.

$R_1$  = Volume control, potentiometer, 500000 ohms  
 $R_2$  = 220000 ohms, 0.5 watt

$R_3$   $R_4$  = 5600 ohms, 0.5 watt  
 $R_5$  = 27000 ohms, 0.5 watt  
 $R_6$  = 560000 ohms, 0.5 watt

(18-18)

### BASS AND TREBLE TONE-CONTROL AMPLIFIER STAGE

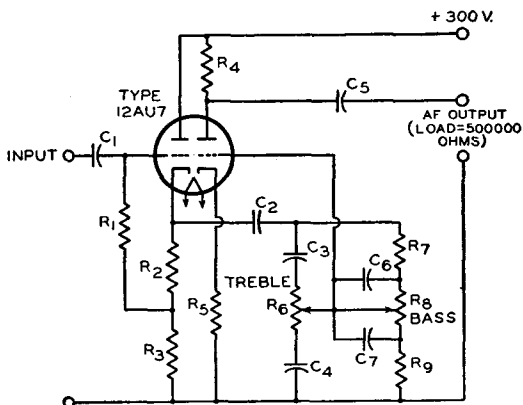

$C_1$  = 0.01  $\mu$ f, paper, 400 v.  
 $C_2$  = 0.02  $\mu$ f, paper, 200 v.  
 $C_3$  = 470  $\mu$ f, mica, 200 v.  
 $C_4$  = 0.005  $\mu$ f, mica, 200 v.  
 $C_5$  = 0.05  $\mu$ f, paper, 400 v.  
 $C_6$  = 0.001  $\mu$ f, paper, 200 v.

$C_7$  = 0.01  $\mu$ f, paper, 400 v.  
 $R_1$  = 560000 ohms, 0.5 watt  
 $R_2$  = 2200 ohms, 0.5 watt  
 $R_3$   $R_4$   $R_7$  = 220000 ohms, 0.5 watt  
 $R_5$  = 5600 ohms, 0.5 watt

$R_6$   $R_8$  = Tone control, potentiometer, 1 megohm, audio taper (10 per cent of total resistance at 50 per cent rotation)  
 $R_9$  = 22000 ohms, 0.5 watt

(18-19)

## NON-MOTORBOATING RESISTANCE-COUPLED AMPLIFIER

Voltage Gain, 9000

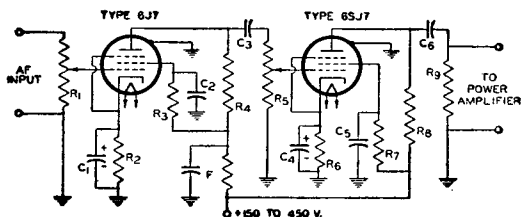

$C_1$   $C_4$  = 8  $\mu$ f, electrolytic, 25 v.  
 $C_2$   $C_5$  = 0.06  $\mu$ f, paper, voltage rating as high as supply voltage  
 $C_3$   $C_6$  = 0.006  $\mu$ f, paper, voltage rating as high as supply voltage

$R_1$  = Volume control, potentiometer  
 $R_2$   $R_6$  = 600 ohms, 0.5 watt  
 $R_3$   $R_7$   $R_8$  = 500000 ohms, 0.5 watt

$R_4$   $R_5$  = 100000 ohms, 0.5 watt  
 $R_5$  = Volume control, potentiometer, 0.5 megohm, ganged with  $R_1$   
 $F$  = Decoupling filter

NOTE: Values of resistance and capacitance shown in this circuit are taken from Charts 14 and 19 in the RESISTANCE-COUPLED AMPLIFIER SECTION. The values are chosen to give a sharp low-frequency cutoff and, thus, to minimize tendency of multiple stages to motorboat. Operation of three or more stages, including power stage, from a common B supply may make it necessary to use a decoupling filter in the plate-supply lead of one or more of the voltage amplifier stages. The constants of decoupling filters depend on the design requirements of the amplifier.

(18-20)

## CODE-PRACTICE OSCILLATOR

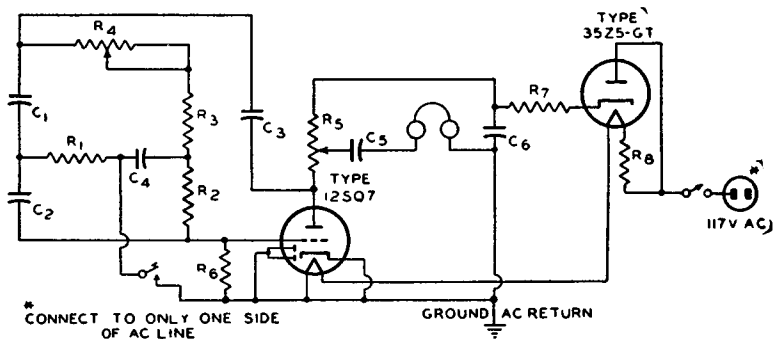

$C_1$   $C_2$  = 0.001  $\mu$ f, mica, 300 v.  
 $C_3$  = 0.01  $\mu$ f, paper, 400 v.  
 $C_4$  = 0.002  $\mu$ f, mica, 300 v.  
 $C_5$  = 0.003  $\mu$ f, paper, 400 v.  
 $C_6$  = 20  $\mu$ f, electrolytic, 250 v.

$R_1$  = 27000 ohms, 0.5 watt  
 $R_2$  = 270000 ohms, 0.5 watt  
 $R_3$  = 220000 ohms, 0.5 watt  
 $R_4$  = Pitch-control, potentiometer, 1.0 megohm

$R_5$  = Volume control, potentiometer, 100000 ohms  
 $R_6$  = 2.2 megohms, 0.5 watt  
 $R_7$  = 47000 ohms, 0.5 watt  
 $R_8$  = 470 ohms, 25 watts

NOTES: (1) The point marked "GROUND AC RETURN" should be connected to a cold-water pipe or other conductor providing a direct, low-resistance return to ground.  
 (2) High-impedance (2000 ohms or more) headphones are required.  
 (3) RCA miniature types 12AV6 and 35W4 may be substituted for the 12SQ7 and 35Z5-GT respectively without affecting performance of the circuit.

(18-21)

## INTERCOMMUNICATION SET With Master Unit and Six Remote Units

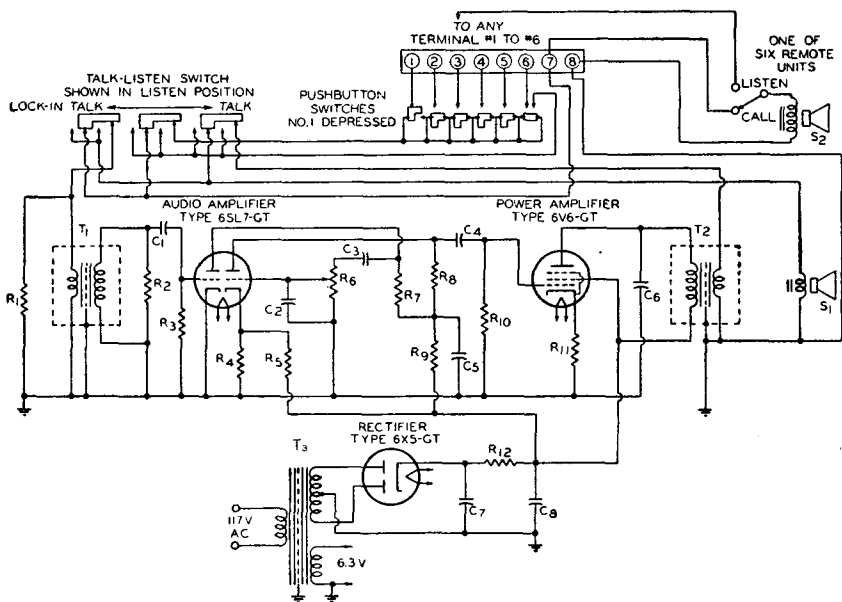

$C_1 = 0.0025 \mu\text{f}$ , paper, 400 v.  
 $C_2 = 470 \mu\text{f}$ , ceramic or mica, 500 v.  
 $C_3 = 330 \mu\text{f}$ , ceramic or mica, 500 v.  
 $C_4 = 0.01 \mu\text{f}$ , paper, 600 v.  
 $C_5 = 0.1 \mu\text{f}$ , paper, 400 v.  
 $C_6 = 5600 \mu\text{f}$ , ceramic or mica, 500 v.  
 $C_7, C_8 = 20 \mu\text{f}$ , electrolytic, 350 v.  
 $R_1 = 12 \text{ ohms}$ , 0.5 watt  
 $R_2 = 470000 \text{ ohms}$ , 0.5 watt

$R_3 = 10 \text{ megohms}$ , 0.5 watt  
 $R_4 = 330 \text{ ohms}$ , 0.5 watt  
 $R_5 = 56000 \text{ ohms}$ , 0.5 watt  
 $R_6 = \text{Volume control, potentiometer, } 500000 \text{ ohms}$   
 $R_7, R_8, R_{10} = 330000 \text{ ohms}$ , 0.5 watt  
 $R_9 = 82000 \text{ ohms}$ , 0.5 watt  
 $R_{11} = 270 \text{ ohms}$ , 2 watts  
 $R_{12} = 470 \text{ ohms}$ , 5 watts  
 $S_1, S_2 = \text{Speakers, permanent-magnet, voice-coil impedance } 13 \text{ ohms}$

$T_1 = \text{Input transformer for matching speaker voice-coil impedance to grid, primary to secondary turns ratio } 1:47.5$   
 $T_2 = \text{Output transformer for matching speaker voice-coil impedance to } 5000\text{-ohm tube load}$   
 $T_3 = \text{Power transformer, } 190\text{-}0\text{-}190 \text{ volts rms, } 50 \text{ ma.}$

(18-22)

ELECTRONIC VOLT-OHM METER

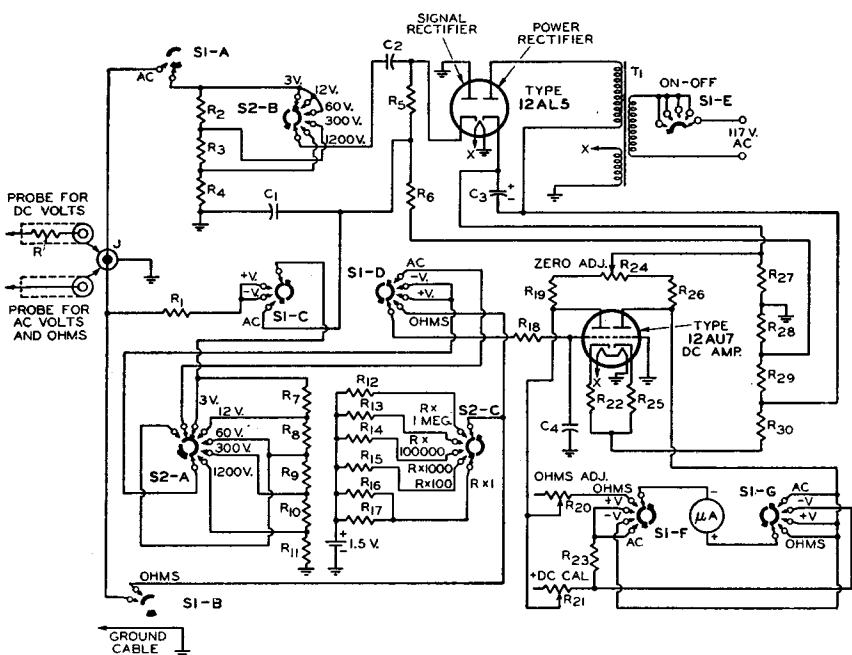

- C<sub>1</sub>=0.1 μf, paper, 200 v.
- C<sub>2</sub>=0.33 μf ±10 per cent, paper, 400 v.
- C<sub>3</sub>=10 μf, electrolytic, 250 v.
- C<sub>4</sub>=0.01 μf, paper, 400 v.
- R=DC-voltage probe isolating resistor, 1 megohm ±5 per cent, 0.5 watt
- R<sub>1</sub>=5 megohms ±1 per cent, 0.5 watt
- R<sub>2</sub>=800000 ohms ±1 per cent, 0.5 watt
- R<sub>3</sub>=1.36 megohms ±1 per cent, 0.5 watt
- R<sub>4</sub>=250000 ohms ±1 per cent, 0.5 watt
- R<sub>5</sub>=678000 ohms ±1 per cent, 0.5 watt
- R<sub>6</sub>=361000 ohms ±1 per cent, 0.5 watt
- R<sub>7</sub>=3.75 megohms ±1 per cent, 0.5 watt
- R<sub>8</sub>=1 per cent, 0.5 watt

- R<sub>9</sub>=200000 ohms ±1 per cent, 0.5 watt
- R<sub>10</sub>=37500 ohms ±1 per cent, 0.5 watt
- R<sub>11</sub>=12500 ohms ±1 per cent, 0.5 watt
- R<sub>12</sub>=10 megohms ±5 per cent, 0.5 watt
- R<sub>13</sub> R<sub>18</sub>=1 megohm ±5 per cent, 0.5 watt
- R<sub>14</sub>=10000 ohms ±5 per cent, 0.5 watt
- R<sub>15</sub>=1000 ohms ±5 per cent, 1 watt
- R<sub>16</sub>=10 ohms ±5 per cent, 2 watts
- R<sub>17</sub>=330 ohms ±5 per cent, 0.5 watt
- R<sub>19</sub>=15000 ohms ±5 per cent, 0.5 watt
- R<sub>20</sub>=Potentiometer, 15000 ohms, 0.5 watt
- R<sub>21</sub>=Potentiometer, 7500 ohms, 0.5 watt

- R<sub>22</sub> R<sub>23</sub>=1500 ohms ±5 per cent, 0.5 watt
- R<sub>24</sub>=470 ohms ±5 per cent, 0.5 watt
- R<sub>24</sub>=Potentiometer, 12500 ohms, 0.5 watt
- R<sub>26</sub>=12000 ohms ±5 per cent, 0.5 watt
- R<sub>27</sub>=47000 ohms ±5 per cent, 0.5 watt
- R<sub>28</sub>=130 ohms ±5 per cent, 0.5 watt
- R<sub>29</sub> R<sub>30</sub>=68000 ohms ±5 per cent, 0.5 watt
- S<sub>1</sub>=Function-selector switch, 7-circuit, 5-position
- S<sub>2</sub>=Range-selector switch, 4-circuit, 5-position
- T<sub>1</sub>=Power transformer, 125 volts rms, 2.75 ma; 10 volts rms, 0.25 ampere
- μA= Meter, dc, 0-200 μa

In the diagram the FUNCTION-SELECTOR SWITCH (S<sub>1</sub>) and RANGE-SELECTOR SWITCH (S<sub>2</sub>) are shown in their maximum counterclockwise positions (S<sub>1</sub>="OFF"; S<sub>2</sub>="3 VOLTS, R × 1")

NOTE: This electronic volt-ohm meter circuit, similar to those used in RCA VoltOhmysts†, is included here solely to illustrate a particular application of RCA Receiving Tubes. It is not recommended for home construction because of the large number of special components required, and because laboratory-type test equipment and reference standards are necessary for proper checking and calibration of the various functions and ranges.

† Trade Mark Reg. U. S. Pat. Off.

# Outlines

## METAL TUBES—Outlines 1-7

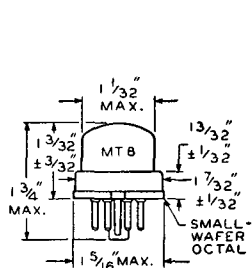

- 1 -

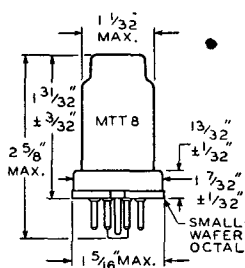

- 2 -

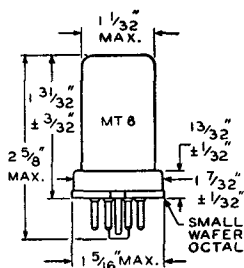

- 3 -

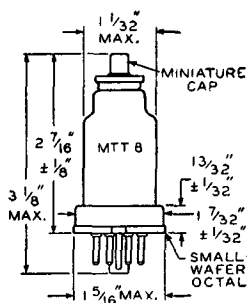

- 4 -

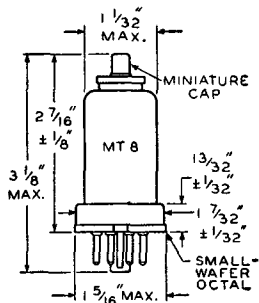

- 5 -

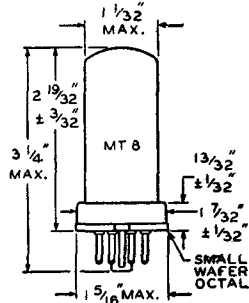

- 6 -

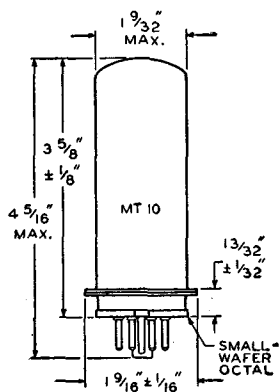

- 7 -

GLASS TUBES—Outlines 8-19

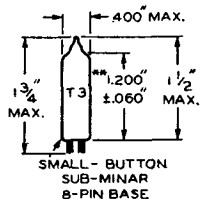

-8-

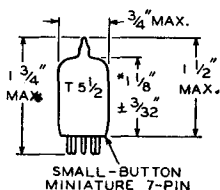

-9-

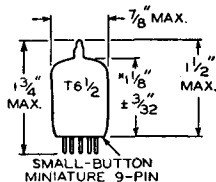

-10-

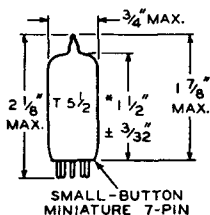

-11-

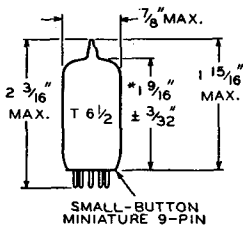

-12-

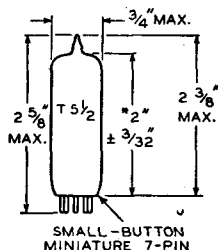

-13-

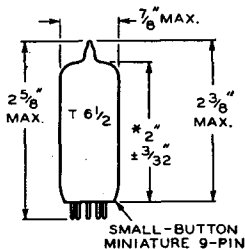

-14-

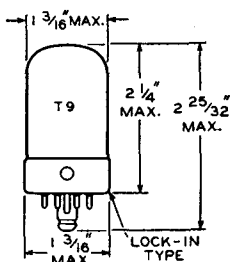

-15-

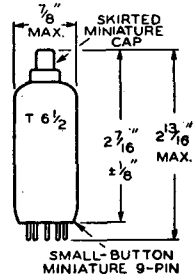

-16-

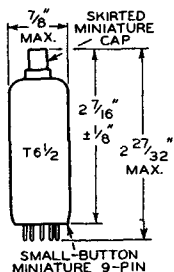

-17-

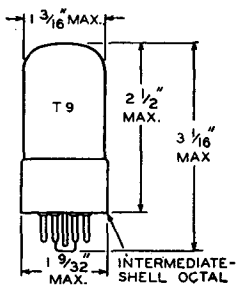

-18-

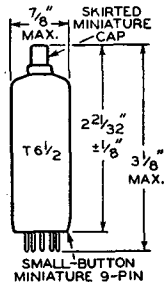

-19-

" MEASURED FROM BASE SEAT TO BULB TOP LINE AS DETERMINED BY RING GAUGE OF 7/16" I.D.  
" MEASURED FROM BASE SEAT TO BULB TOP LINE AS DETERMINED BY RING GAUGE OF .210" I.D.

GLASS TUBES—Outlines 20-28

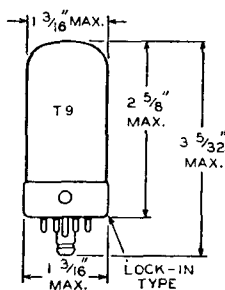

-20-

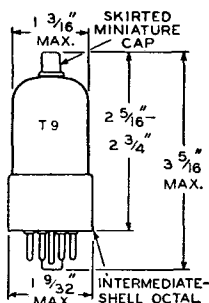

-21-

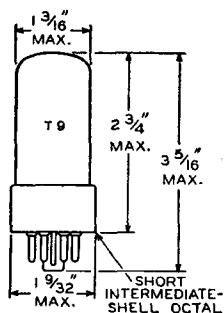

-22-

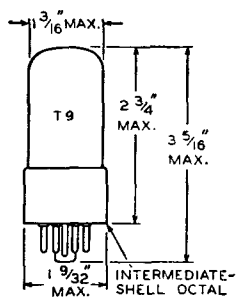

-23-

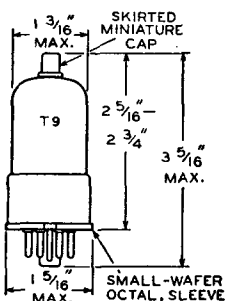

-24-

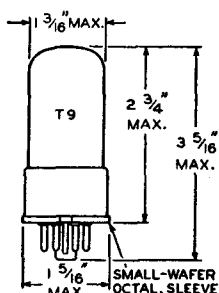

-25-

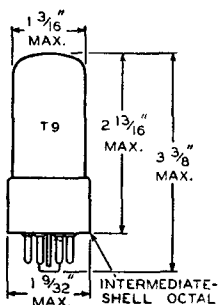

-26-

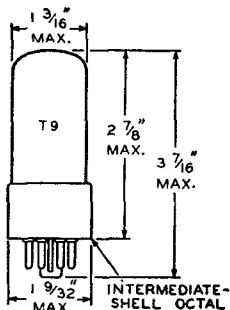

-27-

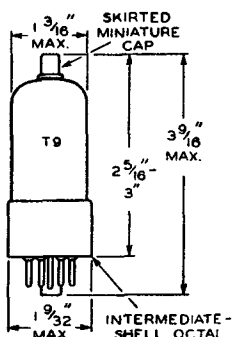

-28-

GLASS TUBES—Outlines 29-37

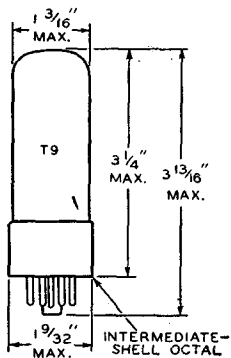

-29-

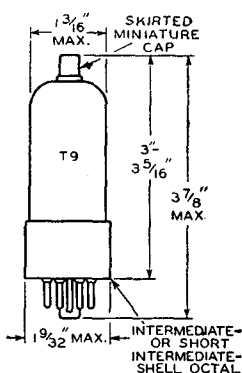

-30-

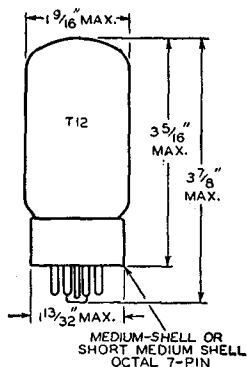

-31-

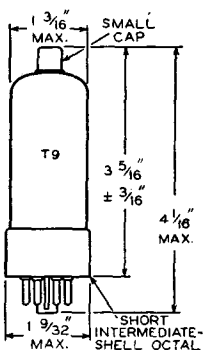

-32-

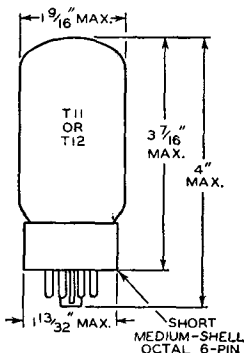

-33-

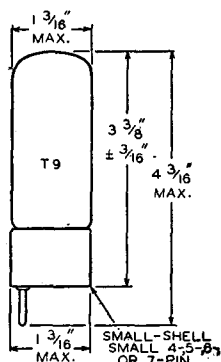

-34-

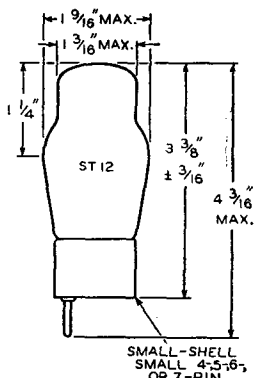

-35-

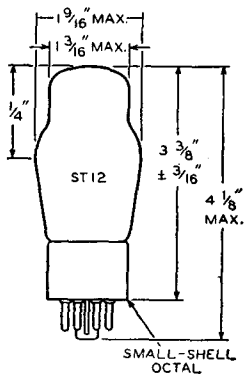

-36-

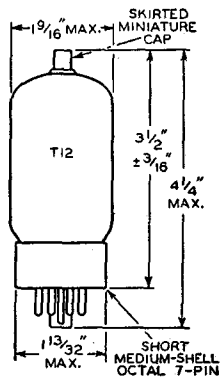

-37-



GLASS TUBES—Outlines 38-46

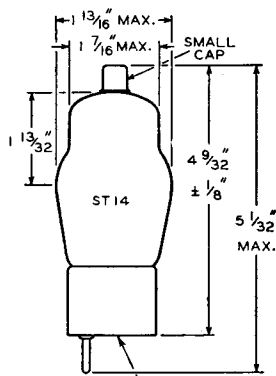
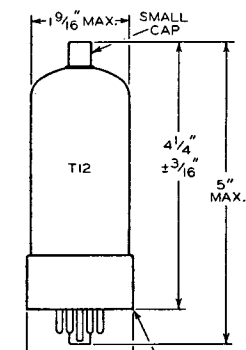
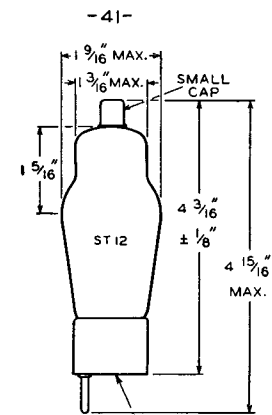
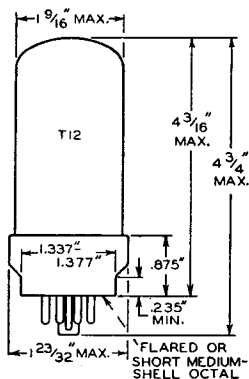
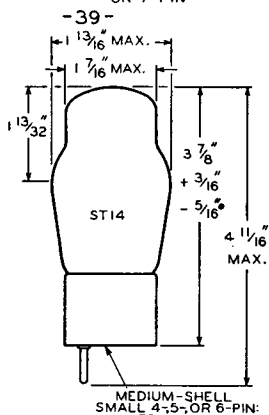
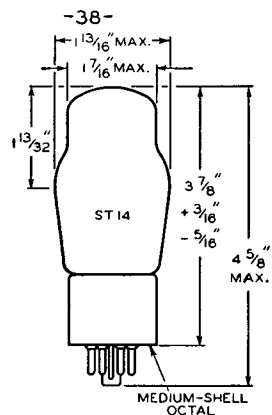
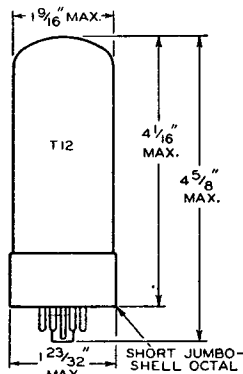
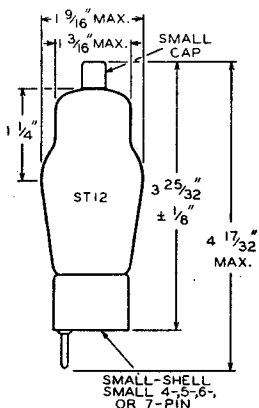
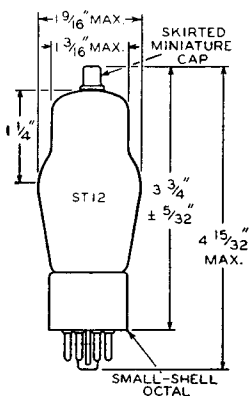

-44-

-45-

-46-

GLASS TUBES—Outlines 47-53

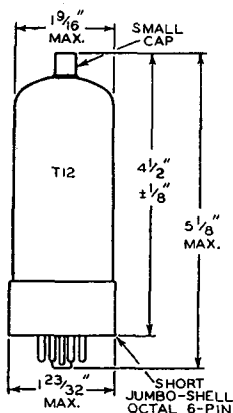

-47-

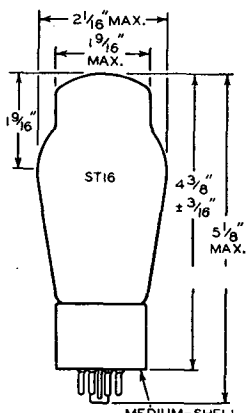

-48-

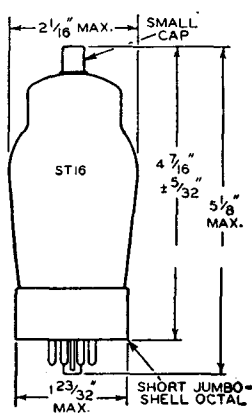

-49-

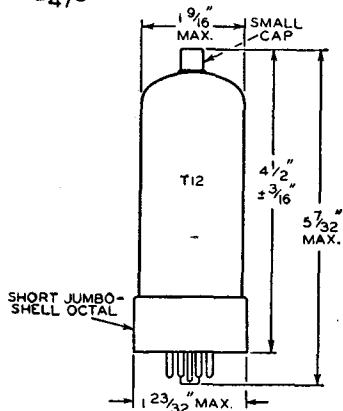

-50-

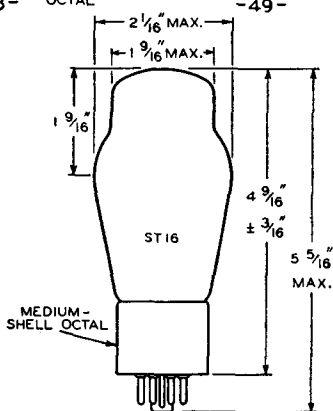

-51-

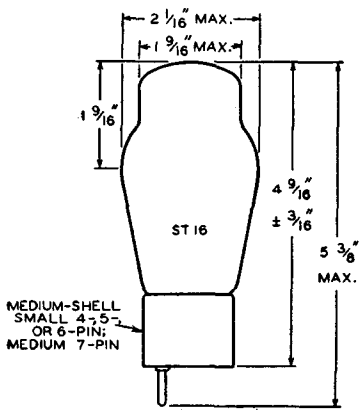

-52-

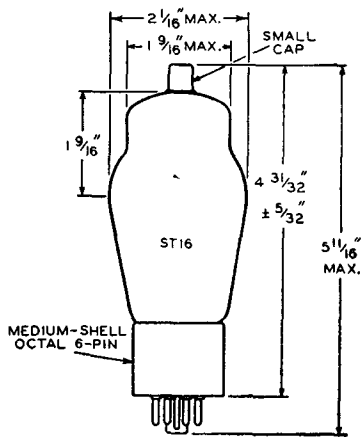

-53-

# INDEX

	<i>Page</i>		<i>Page</i>
<b>Admittance, Input</b> .....	15	load resistance .....	19, 20
<b>Amplification Factor (<math>\mu</math>)</b> .....	11	operating conditions from conversion nomograph .....	20
<b>Amplifier:</b>		peak inverse plate voltage .....	63
audio-frequency .....	13	plate efficiency .....	12
audio mixer, circuit .....	333	plate resistance .....	11
cascode-type .....	33	power output .....	17, 19, 20, 23
cathode-drive .....	25	power sensitivity .....	12
cathode-follower .....	25, 28	screen-voltage dropping resistor .....	67
cathode-follower, circuit .....	335	transconductance .....	12, 29
class A .....	13, 16	voltage amplification (gain) .....	14, 28, 30
class A <sub>1</sub> , circuit .....	331, 336	<b>Capacitor-Input Filter</b> .....	59
class AB .....	13, 21	<b>Cathode:</b>	
class AB <sub>1</sub> .....	22	bias .....	56
class AB <sub>1</sub> , circuit .....	331, 332	bypassing .....	56
class AB <sub>2</sub> .....	24	connection .....	55
class B .....	13, 25	current .....	55
class B, circuit .....	333	directly heated .....	3
class C .....	13	drive .....	25
dc .....	46	follower .....	25, 28, 335
limiter .....	32, 41	indirectly heated .....	4
low-distortion input, circuit .....	334	ionic-heated .....	6
luminance .....	34	resistor .....	56
parallel .....	16	types .....	3
phase-inverter .....	31	<b>Characteristic Curves, Interpretation of</b> ..	65
preamplifier, circuit .....	334	<b>Characteristics:</b>	
push-pull .....	16, 19	amplification factor .....	11
radio-frequency .....	13, 33	control-grid-plate transconductance .....	12
remote-cutoff .....	15, 46	conversion transconductance .....	12
sharp-cutoff .....	46	dynamic .....	11
sync .....	35	plate resistance .....	11
television .....	33	static .....	11
tone control, circuit .....	335	<b>Charts and Tables:</b>	
video .....	34	grid-No.2 input rating chart .....	67
voltage .....	13	picture tube characteristic chart .....	296
volume-expander .....	31	outline drawings .....	339
<b>Amplitude Modulation (AM)</b> .....	38	parts of a miniature pentode .....	2
<b>Anode</b> .....	5	preferred types list .....	Inside Back Cover
<b>Arc-Back Limit</b> .....	63	resistance-coupled amplifiers .....	305
<b>Arc-Back Limit</b> .....	63	structure of miniature tube .....	72
<b>Automatic Frequency Control (AFC)</b> .....	51	tube classification by use and by filament or heater voltage .....	69
<b>Automatic Gain Control (AGC)</b> .....	42, 44	tube-part materials .....	68
<b>Automatic Volume Control (AVC)</b> .....	42	types not recommended for new equipment design .....	Inside Back Cover
<b>Beam Power Tubes</b> .....	8	<b>Choke-Input Filter</b> .....	59
<b>Bias:</b>		<b>Chrominance Channel</b> .....	-35
battery .....	55	<b>Circuit Diagram of:</b>	
cathode (self) .....	55	ac/dc superheterodyne receiver (18-4) ..	323
diode .....	39	ac-operated superheterodyne receiver (18-3) .....	322
grid-resistor .....	40, 55, 56	audio mixer (18-14) .....	333
self (cathode) .....	55	automobile receiver (18-5) .....	324
<b>Calculation of:</b>		bass and treble tone-control amplifier stage (18-18) .....	335
amplification factor .....	11	battery-operated short-wave receiver (18-7) .....	326
cathode (self-bias) resistor .....	56	class B amplifier for mobile use (18-13) ..	333
cathode load resistor .....	29, 30	code practice oscillator (18-20) .....	336
control-grid-plate transconductance .....	12		
filament resistor power dissipation .....	54		
filament (or heater) resistor value .....	53		
harmonic distortion .....	18, 20, 24		

# INDEX (Continued)

	<i>Page</i>	<i>Page</i>	
electronic volt-ohm meter (18-22).....	338	load resistor.....	39
FM tuner (18-9).....	328	Discriminator.....	41
high-fidelity audio amplifier		Dress of Circuit Leads.....	59
class AB <sub>1</sub> —10 watts (18-11).....	331	Driver.....	16, 22, 24
high-power audio amplifier:		Dynamic Characteristics.....	11
class AB <sub>1</sub> —25 watts (18-12).....	332	<b>E</b> lectron:	
intercommunication set (18-21).....	337	considerations.....	3
low-distortion input amplifier		secondary.....	8, 9
stage (18-16).....	334	Electron Tube Applications.....	13
microphone and phonograph amplifier—		Electron Tube Characteristics.....	11
6 watts (18-10).....	330	Electron Tube Installation.....	53
non-motorboating resistance-coupled		Electron Tube Testing.....	302
amplifier (18-19).....	336	Electrons, Electrodes, and Electron Tubes	3
portable superheterodyne receiver		Electron-Ray Tubes.....	45
(18-1).....	320	<b>E</b> mission:	
portable 3-way superheterodyne		current.....	5
receiver (18-2).....	321	secondary.....	8, 9
preamplifier for magnetic phonograph		test.....	303
pickup (18-15).....	332	<b>F</b> eedback:	
superregenerative receiver (18-6).....	325	inverse.....	13, 26
TRF AM tuner (18-8).....	327	undesired.....	56
two-stage input amplifier, cathode-fol-		<b>F</b> ilament (also see Heater and Cathode):	
lower (low-impedance) output (18-17)	335	operation.....	3, 53
Contact Potential.....	57	resistor.....	53
Conversion Nomograph, Use of.....	20	series operation.....	54
Conversion Transconductance.....	12	shunt resistor.....	55
Corrective Filter.....	30	supply voltage.....	53
Cross-Modulation.....	15, 57	<b>F</b> ilter:	
<b>C</b> urrent:		capacitor-input.....	59
cathode.....	55	choke-input.....	59
dc output.....	64	corrective.....	30
grid.....	13, 22	radio-frequency.....	60
peak plate.....	64	smoothing.....	60
plate.....	5	<b>F</b> ormulas (see Calculation)	
Curves, Interpretation of Characteristic..	65	<b>F</b> requency Conversion.....	49
Cutoff.....	15	<b>F</b> requency Modulation (FM).....	38, 40
<b>D</b> C Amplifier.....	46	<b>F</b> ull-Wave Diode Detection.....	39
<b>D</b> eflection Circuits:		<b>F</b> ull-Wave Rectifier.....	5, 36
vertical output.....	48	<b>F</b> uses, Use of.....	55
horizontal output.....	49	<b>G</b> ain (Voltage Amplification).....	14
<b>D</b> egeneration (See Inverse Feedback)		<b>G</b> eneric Tube Types.....	4
<b>D</b> elayed Automatic Volume Control		<b>G</b> rid:	
(DAVC).....	43	anode.....	50
<b>D</b> emodulation.....	38	bias.....	56
<b>D</b> esign-Center System of Ratings.....	65	bias detection.....	40
<b>D</b> etection:		control.....	6
diode.....	38	current.....	13, 22
discriminator.....	41	resistor.....	14, 55
full-wave diode.....	39	resistor and capacitor detection.....	40
grid bias.....	40	screen.....	7
grid-resistor and capacitor.....	40		
ratio detector.....	41		
<b>D</b> iode:			
biasing.....	39		
considerations.....	5		
detection.....	38		

## INDEX (Continued)

	<i>Page</i>		<i>Page</i>
suppressor .....	8	Multi-Electrode Tube .....	9
voltage supply .....	55	Multi-Unit Tubes .....	9
Grid-Plate Capacitance .....	7	Multivibrator .....	46
Grid-Plate Transconductance .....	12	Mutual Conductance (see Transconductance)	
<b>Half-Wave Rectifier</b> .....	5, 36	<b>Oscillator:</b>	
Harmonic Distortion .....	18, 20, 24	considerations .....	46
Heater:		multivibrator .....	46
cathode .....	4	relaxation .....	46
cathode bias .....	55	synchroguide .....	47
cathode connection .....	55	Outlines of Tubes .....	339
resistor .....	55	Output Capacitance .....	65
series operation .....	54	Output Circuits:	
shunt resistor .....	55	vertical .....	48
supply voltage .....	53	horizontal .....	49
Hexode Mixer .....	51	Output-Coupling Devices .....	61
Horizontal Output Circuits .....	49	<b>Parallel Operation</b> .....	16, 36
<b>Impedance, Input</b> .....	15	Parasitic Oscillations .....	17
Input Capacitance .....	65	Parts of a Miniature Pentode .....	2
Instantaneous Peak Voltage .....	60	Peak Inverse Plate Voltage .....	63
Interelectrode Capacitances .....	7, 65	Peak Plate Current .....	64
Intermediate Frequency, Production of .....	49	Pentagrid Converter .....	9, 50
Interpretation of Tube Data .....	63	Pentagrid Mixer .....	31, 51
Inverse Feedback:		Pentode Considerations .....	8
constant-current type .....	26, 27	Phase Inverter .....	31, 308
constant-voltage type .....	26	Picture Tube:	
<b>Key to Socket Connection</b>		basing diagrams .....	300
Diagrams .....	Inside Front Cover	characteristics chart .....	296
Kinescopes .....	9	corona considerations .....	61
<b>Limiter</b> .....	32	deflection .....	10
Load:		dust considerations .....	61
resistance .....	19, 20	essential elements .....	9
resistance line .....	17, 22	handling precautions .....	62
Low-Distortion Input Amplifier Stage .....	334	high-voltage considerations .....	61
Luminance Amplifier .....	34	humidity considerations .....	61
Mercury-Vapor Rectifier:		safety considerations .....	62
considerations .....	6	screen .....	9
interference from .....	60	structure .....	9
Mho .....	12	x-ray radiation precautions .....	62
Micromho .....	12	<b>Plate:</b>	
Miniature Tube, Structure of .....	72	current .....	5
<b>Mixer:</b>		dissipation .....	63
audio .....	333	efficiency .....	12
hexode .....	51	load .....	19, 20
pentagrid .....	51	resistance .....	11
Modulated Wave .....	38, 41	voltage supply .....	55
Modulation .....	38	<b>Plate-Cathode Capacitance</b> .....	7, 65
Modulation-Distortion .....	15, 57	<b>Power Output:</b>	
		calculations .....	17, 19, 20, 23
		test .....	304
		<b>Power Sensitivity</b> .....	11

# INDEX (Continued)

	<i>Page</i>		<i>Page</i>
Power Supply .....	53	Symbols Used in Resistance-Coupled Amplifier Charts .....	307
Preamplifier for Magnetic Phonograph Pickup .....	334	Sync Circuits .....	35
Preferred Types List .....	Inside Back Cover	Synchroguide .....	47
Push-Pull Operation .....	16, 19	<b>Tables and Charts:</b> (see Charts and Tables)	
<b>Radio-Frequency:</b>		Technical Data for Tube Types .....	73
amplifier .....	13, 33	Television Picture Tubes .....	9
filter .....	60	Television RF Amplifiers .....	33
Ratings, Design-Center System .....	65	Television Sync Circuits .....	35
Ratio Detector .....	41	Testing Electron Tubes .....	302
Reading List .....	352	Tetrode Considerations .....	7
Receiving Tube Classification Chart .....	69	<b>Tone-Control Amplifier Stage</b> .....	335
Rectifiers:		<b>Transconductance:</b>	
full-wave .....	5, 36	conversion .....	12
half-wave .....	5, 36	grid-plate .....	12
ionic-heated cathode .....	6	test .....	303
parallel operation of .....	36	<b>Triode Considerations</b> .....	6
plate characteristics curves .....	64	<b>Tube:</b>	
voltage doubler .....	37	outlines .....	339
Relaxation Oscillator .....	46	parts of miniature .....	2
Remote-Cutoff Tubes .....	15, 46	ratings, interpretation of .....	63
Resistance Coupling .....	31	structure of miniature .....	72
Resistance-Coupled Amplifier .....	14, 27, 306	tester requirements .....	304
Resistor:		<b>Tube Types:</b>	
cathode (self-biasing) .....	56	technical data .....	73
center tap .....	55	<b>Tuning Indicators</b> .....	45
filament .....	53	<b>Twin Diode:</b>	
filter .....	59	pentode .....	9
grid .....	14	triode .....	9, 39
plate load .....	19, 20	<b>Typical Operation Values,</b> Interpretation of .....	65
screen-grid .....	58, 67	<b>Vertical Output Circuits</b> .....	48
<b>Saturation Current</b> .....	5	<b>Video Amplifiers</b> .....	34
Screen Grid (Grid No. 2):		<b>Voltage:</b>	
considerations .....	7	amplification, class A .....	13
input .....	63, 67	doubler rectifier .....	37
voltage supply .....	57	peak heater-cathode .....	63
Secondary Emission .....	8	peak inverse plate .....	63
Secondary Electrons .....	8, 9	supply .....	53
Self-bias (cathode bias) .....	55	<b>Voltage Doubler</b> .....	37
Shielding .....	58	<b>Volume Control:</b>	
Short-Circuit Test .....	302	automatic (AVC) .....	42
Socket Connection Diagrams, Key to .....	Inside Front Cover	by grid-voltage variation .....	57
Space Charge .....	5, 9	by screen-grid-voltage variation .....	58
Static Characteristics .....	11	delayed automatic (DAVC) .....	43
Structure of a Miniature Tube .....	72	<b>Volume Expander</b> .....	31
Suppressor Grid (Grid No. 3) .....	8	<b>Zero-Bias Operation</b> .....	55

# RCA Technical Publications

## on Tubes, Semiconductor Devices, Electronic Components, Batteries, and Test and Measuring Equipment

Copies of the publications listed below may be obtained from your RCA distributor or from Commercial Engineering, Radio Corporation of America, Harrison, N. J.

### Electron Tubes

● **RCA TUBE HANDBOOK**—HB-3 (7 $\frac{3}{8}$ " x 5"). Five deluxe 2-inch-capacity binders imprinted in gold. The bible of the industry—contains over 3100 pages of loose-leaf data and curves on RCA receiving tubes, picture tubes, cathode-ray tubes, phototubes, transmitting tubes, special tubes, and semiconductor devices. Available on subscription basis. Price \$17.50\* including service for first year. Write to Commercial Engineering for descriptive folder and order form.

● **RCA RECEIVING TUBE MANUAL**—RC-18 (8 $\frac{3}{8}$ " x 5 $\frac{3}{8}$ ")—352 pages. Revised, expanded, and brought up to date. Contains technical data on more than 575 receiving tubes, including types for black-and-white and color television and series-string applications. Features tube theory written for the layman, application data for radio and television circuits, Resistance-Coupled Amplifier Section, and several circuits for high-fidelity audio amplifiers. Features lie-flat binding. Price 75 cents.\*

● **RCA TRANSMITTING TUBES**—TT-4 (8 $\frac{3}{8}$ " x 5 $\frac{3}{8}$ ")—256 pages. Contains basic information on generic tube types, on tube parts and materials, on tube installation and application, and on interpretation of tube data. Includes maximum ratings, typical operating values, and characteristics curves for power tubes having plate-input ratings up to 4 kilowatts, and maximum ratings and operating values for associated rectifier tubes. Contains sections on transmitter-design considerations and on rectifier circuits and filters. Features classification charts for quick, easy selection of tubes, and circuit diagrams for transmitting and industrial applications. Features lie-flat binding. Price \$1.00.\*

● **RADIOTRON† DESIGNER'S HANDBOOK**—4th Edition (8 $\frac{3}{4}$ " x 5 $\frac{1}{2}$ ")—1500 pages. Comprehensive reference thoroughly covering the design of radio and audio circuits and equipment. Written for the design engineer, student, and experimenter. Contains 1000 illustrations, 2500 references, and cross-referenced index of 7000 entries. Edited by F. Langford-Smith of Amalgamated Wireless Valve Co., Pty., Ltd. in Australia. Price \$7.00.\*

● **RCA POWER AND GAS TUBES**—PG-101C (10 $\frac{7}{8}$ " x 8 $\frac{3}{8}$ ")—24 pages. Completely revised and brought up to date. Technical information on 174 RCA vacuum power tubes, rectifier tubes, thyratrons, ignitrons, magnetrons, and vacuum-gauge tubes. Includes terminal connections. Price 20 cents.\*

● **RECEIVING-TYPE TUBES FOR INDUSTRY AND COMMUNICATIONS**—RT-104 (10 $\frac{7}{8}$ " x 8 $\frac{3}{8}$ ")—20 pages. Technical information on 130 RCA "special red" tubes, premium tubes, computer tubes, pencil tubes, glow-discharge tubes, small thyratrons, low-microphonic amplifier tubes, and other special types. Includes socket-connection diagrams. Price 20 cents.\*

● **RCA RECEIVING TUBES FOR AM, FM, AND TELEVISION BROADCAST**—1275-G (10 $\frac{7}{8}$ " x 8 $\frac{3}{8}$ ")—28 pages. New booklet contains classification chart, characteristics chart, and base and envelope connection diagrams on more than 600 entertainment receiving tubes and picture tubes. Price 25 cents.\*

● **RCA PICTURE TUBES**—KB-106 (10 $\frac{7}{8}$ " x 8 $\frac{3}{8}$ ")—16 pages. Contains characteristics and base-connection diagrams for RCA's complete line of picture tubes. Features an interchangeability directory on more than 150 types. Price 20 cents.\*

● **RCA TUBE PICTURE BOOK**—TPB-1 (10 $\frac{7}{8}$ " x 8 $\frac{3}{8}$ ")—16 pages. Collection of photographs and cutaway drawings of representative tube types. Prepared especially for use by students. A visual

†Trade Mark Reg. U. S. Pat. Off. \*Prices shown apply in U.S.A. & are subject to change without notice.

aid for the details of tube construction. Price 25 cents.\*

• **TECHNICAL BULLETINS**—Authorized information on RCA transmitting tubes and other tubes for communications and industry. Be sure to mention tube-type bulletin desired. Single copy on any type free on request.

• **RCA PREFERRED TYPES LIST**—PTL-501-B (10 $\frac{7}{8}$ " x 8 $\frac{3}{8}$ ")—4 pages. Lists RCA Preferred Tube Types, both receiving and non-receiving, by function. An aid to equipment designers in the selection of tube types for new equipment design. Single copy free on request.

• **RCA PHOTSENSITIVE DEVICES AND CATHODE-RAY TUBES**—CRPD-105 (10 $\frac{7}{8}$ " x 8 $\frac{3}{8}$ ")—24 pages. Contains technical information on 109 RCA tubes including single-unit, twin-unit, and multiplier phototubes; flying-spot tubes; monitor, projection, transcriber, and view-finder kinescopes; and storage tubes. Price 20 cents.\*

• **HEADLINERS FOR HAMS**—HAM-103B (10 $\frac{7}{8}$ " x 8 $\frac{3}{8}$ ")—4 pages. Technical information and terminal-connection diagrams for 48 RCA "HAM" PREFERENCE TYPES: modulators, class C amplifiers and oscillators, frequency multipliers, rectifier tubes, thyratrons, glow-discharge (cold-cathode) tubes, and cathode-ray tubes. Single copy free on request.

• **RCA INTERCHANGEABILITY DIRECTORY OF INDUSTRIAL-TYPE ELECTRON TUBES**—ID-1020A (10 $\frac{7}{8}$ " x 8 $\frac{3}{8}$ ")—16 pages. Lists more than 2000 type designations of 26 different manufacturers arranged in alphabetical-numerical sequence; shows the RCA Direct Replacement Type or the RCA Similar Type, when available. Price 20 cents.\*

## Semiconductor Devices

• **RCA TRANSISTORS**—Technical bulletins containing authorized information on RCA transistors. Be sure to mention transistor-type bulletin desired. Single copy free on request.

• **RCA SEMICONDUCTOR DIODES**—Technical bulletin containing authorized information on semiconductor diodes of the germanium point-contact type: general-purpose type 1N34-A, high-back-

resistance type 1N54-A, and large-signal types 1N38-A and 1N58-A. Bulletin includes diode characteristics and performance curves. Single copy free on request.

## Components and Service Parts

• **SERVICE PARTS DIRECTORIES FOR RCA VICTOR TV RECEIVERS**

SP-1007—1946-1950 (10 $\frac{7}{8}$ " x 16 $\frac{3}{4}$ ")—80 pages. Schematic diagrams and replacement parts lists for all RCA Victor TV receivers manufactured from 1946 through June 1950 (56 models). Each schematic diagram faces its corresponding parts list for quick reference. Price 75 cents.\*

SP-1014—1950-1951 (10 $\frac{7}{8}$ " x 16 $\frac{3}{4}$ ")—142 pages. Schematic diagrams, replacement parts lists, and top and bottom chassis views for the 71 models of 1950 and 1951 RCA Victor TV receivers. The comprehensive index for model and chassis numbers provides a ready source of reference. Price \$1.50.\*

SP-1021—1952 (10 $\frac{7}{8}$ " x 16 $\frac{3}{4}$ ")—36 pages. Schematic diagrams, wiring diagrams, replacement parts lists, and top and bottom chassis views for the 27 models of 1952 RCA Victor TV receivers. The comprehensive index cross-references RCA TV model names to model numbers, and model numbers to the publication in which information may be found. Price 50 cents.\*

SP-1028—1953 (10 $\frac{7}{8}$ " x 16 $\frac{3}{4}$ ")—84 pages. Schematic diagrams, wiring diagrams, replacement parts lists, and top and bottom chassis views for the 108 models of 1953 RCA Victor TV receivers. Also includes schematic diagrams, replacement parts, and other information for radio chassis used in radio-TV combination receivers. Cross-references model names to model numbers of all RCA TV receivers from 1946 through 1953. Cross-references all model numbers and chassis numbers to the publication in which information may be found. Price \$1.35.\*

SP-1035—1954 (10 $\frac{7}{8}$ " x 16 $\frac{3}{4}$ ")—72 pages. Schematic diagrams, top and bottom chassis views, replacement parts lists, and top and bottom chassis adjust-

†Trade Mark Reg. U. S. Pat. Off. \*Prices shown apply in U.S.A. & are subject to change without notice.



ments for the 106 models of 1954 RCA Victor TV receivers. Also included is information on the CT-100 and the 21-CT55 Color Television Receivers, and the RP-197 and RP-198 3-speed record changers. The comprehensive index references model names to model numbers of all RCA Victor TV receivers from 1946 through 1954, and all model and chassis numbers to the Service Parts Directory in which information may be found. Price \$1.25.\*

● **RCA COMPONENTS DIRECTORY FOR TV RECEIVERS**—SP-1006C (10 $\frac{7}{8}$ " x 8 $\frac{3}{8}$ ")—52 pages. List major components of 100 different brands of TV receivers for which RCA replacement components are available. Prepared especially for service technicians and parts distributors. Easy-to-use format simplifies location of proper replacement part. Price 50 cents.\*

● **TV SERVICING**. Bulletin TVS-1030 (10 $\frac{7}{8}$ " x 8 $\frac{3}{8}$ ")—48 pages. This new booklet contains a compilation of articles on TV trouble shooting, TV tuner alignment, and TV circuit analysis by two of RCA's experts in the field of TV servicing and test equipment—John R. Meagher and Art Liebscher. Price 35 cents.\*

● **TV SERVICING, SUPPLEMENT 1**. Bulletin TVS-1031 (10 $\frac{7}{8}$ " x 8 $\frac{3}{8}$ ")—12 pages. This new booklet contains an article by John R. Meagher on solving trouble shooting problems in those hard-to-service television receivers known to service technicians as "tough" sets or "dogs." Emphasizes time-saving component-checking techniques and proper use of test equipment. Price 15 cents.\*

● **RCA VICTOR TV SERVICE PARTS GUIDE**—SP-2001B (10 $\frac{7}{8}$ " x 8 $\frac{3}{8}$ ")—16 pages. Lists stock numbers of major replacement parts for RCA Victor TV sets by receiver-model number and corresponding receiver-chassis number. Also lists stock numbers of tuner-replacement parts for individual tuner chassis. Cover periods from 1946 through 1956. Price 25 cents.\*

● **RCA PHONOGRAPH CARTRIDGE GUIDE**—SP-2003B (10 $\frac{7}{8}$ " x 8 $\frac{3}{8}$ ")—4 pages. Lists stock numbers of RCA cartridges and replacement styli. Also lists stock numbers of RCA cartridges and model

numbers of record players by RCA Victor model numbers. Single copy free on request.

## Batteries

● **RCA RADIO BATTERIES FOR FLASHLIGHT, RADIO, AND INDUSTRIAL APPLICATIONS**—BAT-134B (10 $\frac{7}{8}$ " x 8 $\frac{3}{8}$ ")—8 pages. Contains characteristics, terminal connections, and socket patterns of 82 RCA dry batteries for radio, flashlight, and industrial applications. Includes interchangeability directory, and a battery replacement guide for 1948 to 1954 inclusive for portable radios. Single copy free on request.

## Test and Measuring Equipment

**INSTRUCTION BOOKLETS**—Illustrated instruction booklets, containing specifications, operating and maintenance data, application information, schematic diagrams, and replacement parts lists, are available for all RCA test instruments. Booklets for the following popular instruments are available at the prices indicated. Prices for booklets on other instruments are available on request.

WR-36A (Dot-Bar Generator)†	\$.50*
WA-44A (AudioSignal Generator)	0.50*
WA-44B (AudioSignal Generator)	0.50*
WR-46A (Video Dot/Crosshatch Generator)	0.75*
WR-49A (RF Signal Generator)	0.50*
WO-56A (7" Oscilloscope)	0.50*
WR-59C (TV Sweep Generator)	0.50*
WR-61A (Color-Bar Generator)	0.50*
WR-61B (Color-Bar Generator)	0.50*
WR-70-A (RF-IF-VF Marker Adder)	0.75*
WV-77A (Junior VoltOhmyst†)	0.25*
WV-77B (Junior VoltOhmyst†)	0.25*
WV-78A (5" Oscilloscope)	\$0.50*
WR-84A (Ultra-Sensitive DC Microammeter)	0.25
WR-86A (UHF Sweep Generator)	0.50*
WV-87A (Master VoltOhmyst†)	0.50*
WO-88A (5" Oscilloscope)	0.50*
WR-89A (Crystal-Calibrated Marker Generator)	0.50*
WO-91A (5" Oscilloscope)	1.00
WV-97A (Senior VoltOhmyst†)	0.50*
WV-98A (Senior VoltOhmyst†)	0.75*
WT-100A (Electron-Tube MicroMhoMeter)	1.75*

†Trade Mark Reg. U. S. Pat. Off. \*Prices shown apply in U.S.A. & are subject to change without notice.

# Reading List

This list includes references of both elementary and advanced character. Obviously, the list is not inclusive, but it will guide the reader to other references.

- ALBERT, A. L. *Fundamental Electronics and Vacuum Tubes*. The MacMillan Co.
- CHAFFEE, E. L. *Theory of Thermionic Vacuum Tubes*. McGraw-Hill Book Co., Inc.
- CHUTE, G. M. *Electronics in Industry*. McGraw-Hill Book Co., Inc.
- DOMÉ, R. B. *Television Principles*. McGraw-Hill Book Co., Inc.
- DOW, W. G. *Fundamentals of Engineering Electronics*. John Wiley and Sons, Inc.
- EASTMAN, A. V. *Fundamentals of Vacuum Tubes*. McGraw-Hill Book Co., Inc.
- EVERITT, W. L. *Communication Engineering*. McGraw-Hill Book Co., Inc.
- FINK, D. G. *Engineering Electronics*. McGraw-Hill Book Co., Inc.
- FINK, D. G. *Television Engineering*. McGraw-Hill Book Co., Inc.
- GHIRARDI, A. A. *Radio and Television Receiver Circuitry and Operation*. Rinehart and Co., Inc.
- GRAY, T. S. *Applied Electronics*. John Wiley and Sons, Inc.
- GROB, B. *Basic Television*. McGraw-Hill Book Co., Inc.
- HENNEY, KEITH *Radio Engineering Handbook*. McGraw-Hill Book Co., Inc.
- HOAG, J. B. *Basic Radio*. D. Van Nostrand Co., Inc.
- KOLLER, L. R. *Physics of Electron Tubes*. McGraw-Hill Book Co., Inc.
- MAEDEL, G. F. *Basic Mathematics for Television and Radio*. Prentice-Hall, Inc.
- MARCUS, A. *Elements of Radio*. Prentice-Hall, Inc.
- MARKUS AND ZELUFF. *Handbook of Industrial Electronic Circuits*. McGraw-Hill Book Co., Inc.
- MOYER AND WOSTREL. *Radio Receiving and Television Tubes*. McGraw-Hill Book Co., Inc.
- PENDER, DELMAR, AND MCILWAIN. *Handbook for Electrical Engineers—Communications and Electronics*. John Wiley and Sons, Inc.
- PREISMAN, A. *Graphical Constructions for Vacuum Tube Circuits*. McGraw-Hill Book Co., Inc.
- Proceedings of the Institute of Radio Engineers* (a monthly publication).
- RCA TECHNICAL BOOK SERIES. *Electron Tubes, Vol. I and Vol. II*. RCA Review.
- REICH, H. J. *Theory and Applications of Electron Tubes*. McGraw-Hill Book Co., Inc.
- RICHTER, WALTHER. *Fundamentals of Industrial Electronic Circuits*. McGraw-Hill Book Co., Inc.
- SPANGENBERG, K. R. *Vacuum Tubes*. McGraw-Hill Book Co., Inc.
- TERMAN, F. E. *Fundamentals of Radio*. McGraw-Hill Book Co., Inc.
- TERMAN, F. E. *Radio Engineers Handbook*. McGraw-Hill Book Co., Inc.
- The Radio Amateurs Handbook*. American Radio Relay League.
- VAN DER BIJL, H. J. *Thermionic Vacuum Tubes*. McGraw-Hill Book Co., Inc.
- ZWORYKIN AND MORTON. *Television: The Electronics of Image Transmission*. John Wiley and Sons, Inc.

## RCA Receiving Types NOT Recommended For New Equipment Design

Certain receiving tube types should be avoided in the design of new equipment because they are approaching obsolescence or have limited or dwindling demand. Such RCA Types are listed below. For a guide to the selection of tube types recommended for new equipment design, refer to the RECEIVING TUBE CLASSIFICATION CHART.

OZ4	6A8	6F6-G	7A5	7W7	24-A
OZ4-G	6A8-G	6F6-GT	7A6	7X7	25BQ6-GT
1A5-GT	6A8-GT	6F7	7A7	7Y4	25W4-GT
1AD5	6AB5/6N5	6F8-G	7A8	7Z4	25Z5
1AX2	6AB7	6G6-G	7AD7	12A8-GT	27
1C5-GT	6AC5-GT	6J7-GT	7AF7	12AH7-GT	35A5
1E8	6AD7-G	6K7	7AG7	12AV7	35Y4
1L6	6AH4-GT	6K7-GT	7AH7	12BD6	35Z3
1LA6	6AH6	6N7	7B4	12C8	35Z4-GT
1LB4	6AL7-GT	6Q7	7B5	12J5-GT	41
1LC5	6AQ7-GT	6Q7-GT	7B6	12J7-GT	42
1LC6	6AR5	6R7	7B7	12K7-GT	43
1LD5	6B4-G	6S4	7B8	12K8	45
1LE3	6B8	6S7	7C5	12Q7-GT	47
1LG5	6BD4-A	6S8-GT	7C6	12SA7-GT	50A5
1LH4	6BD6	6SA7-GT	7C7	12SF7	50C6-G
1LN5	6BF5	6SB7-Y	7E7	12SK7-GT	50X6
1S4	6BK5	6SF5-GT	7F7	14A7	50Y7-GT
1-v	6BK7-A	6SF7	7F8	14AF7	70L7-GT
1V2	6BQ6-GT	6SJ7-GT	7G7	14B6	75
1X2-A	6BY5-GA	6SK7-GT	7H7	14C7	78
3LF4	6C5-GT	6SQ7-GT	7J7	14F7	80
5AZ4	6C6	6SR7	7K7	14F8	83-v
5T4	6C8-G	6SS7	7L7	14Q7	84/6Z4
5U4-G	6CD6-G	6SZ7	7N7	14R7	117L7/M7-GT
5X4-G	6D6	6U5	7Q7	19BG6-GA	117N7-GT
5Z3	6F5	6Y6-G	7R7	19J6	117P7-GT
6A7	6F5-GT	7A4	7V7	19T8	117Z6-GT

---

### RCA Preferred Types List

A list of preferred tube types is available to assist equipment designers and manufacturers in formulating their plans for future production of electronic equipment. This list is based on periodic surveys of the needs of the engineering and manufacturing fields and keeps abreast of technological advances in tube design and application.

A copy of the current list will be gladly furnished on request. Write to Commercial Engineering, Tube Division, Radio Corporation of America, Harrison, N. J.

