

CHAPTER 21

THE NETWORK BETWEEN THE POWER VALVE AND THE LOUDSPEAKER

BY F. LANGFORD-SMITH, B.Sc., B.E.

Section	Page
1. Loudspeaker "matching"	880
2. Multiple and extension loudspeakers	882
3. Loudspeaker divider networks	887
4. References	889

SECTION 1 : LOUDSPEAKER "MATCHING"

(i) *Loudspeaker characteristics and matching* (ii) *Optimum plate resistance* (iii) *Procedure for "matching" loudspeakers to various types of amplifiers.*

(i) Loudspeaker characteristics and matching

If the impedance of a loudspeaker were a constant resistance, the problem would be simple. In reality, the magnitude of the impedance may vary in a ratio up to 10 : 1 and the phase angle may be anything between 50° leading and 60° lagging—see Chapter 20 Sect. 1(v).

A loudspeaker, or output, transformer is an impedance changing device, with an impedance ratio approximately equal to the square of the turns ratio (see Chapter 5). The transformer by itself has no "impedance" in this sense—it merely reflects across the primary the load impedance placed across the secondary terminals, multiplied by its impedance ratio. Example : A transformer has a turns ratio 10 : 1 from primary to secondary. Its impedance ratio is therefore 100 : 1 primary to secondary. If the secondary load is 8 ohms, the reflected "primary impedance" will be 800 ohms. The only limitations on the wider use of the same transformer are the primary inductance, which will reduce the low frequency response, the maximum d.c. plate current and the maximum power output.

(ii) Optimum plate resistance

The power output of a loudspeaker is equal to the power input multiplied by the efficiency. The power input to the primary of the loudspeaker transformer, under the usual operating conditions, is equal to the square of the signal plate current multiplied by the reflected load resistance—

$$\text{Power input in watts} = I_p^2 R_L \tag{1}$$

where I_p = signal plate current in amperes, r.m.s.
and R_L = load resistance reflected on to the primary of the transformer.

The signal plate current is given by

$$I_p = \mu E_g / (r_p + R_L) \tag{2}$$

where μ = amplification factor of power output valve
 E_g = signal grid voltage, r.m.s.
and r_p = effective plate resistance of power output valve.

Consequently, at the bass resonant frequency where the resistance R_L may rise to a high value, it is possible to have maximum plate circuit efficiency and yet to have

less than the maximum electrical power output, because the signal plate current is reduced by the high load resistance. This effect is most pronounced with low values of plate resistance, and with triode valves or negative feedback the loudspeaker acoustical output may actually fall at the bass resonant frequency. With pentodes without feedback the reverse occurs, since a pentode approximates to a constant current source, and there is a high peak of output at the bass resonant frequency.

A similar effect occurs at the higher frequencies, the highest level of response occurring with pentodes, an intermediate value with triodes having $R_L = 2r_p$, and the lowest with constant voltage at all frequencies (a condition approached when a high value of negative feedback is used).

For any one loudspeaker, there is a value of plate resistance which provides most nearly constant response at all frequencies.

Reference 5.

(iii) Procedure for "matching" loudspeakers to various types of amplifiers

When the load resistance is constant, the only procedure necessary is to select a transformer ratio so that the resistance reflected into the primary is the correct load for the amplifier. When the load is a loudspeaker, the procedure is outlined below.

Class A Triodes, either singly or in push-pull, may be treated very simply by arranging for the loudspeaker impedance at 400 c/s to equal the correct load for the amplifier. Thanks to the shape of the triode characteristics, the rise of impedance at the bass resonant frequency decreases the distortion, and although the power output from the valve is lower than at 400 c/s this is counterbalanced by the rise of loudspeaker efficiency at this frequency. The rise of impedance above 400 c/s results in a tendency towards a falling response, but loudspeakers specially designed for use with triodes are capable of giving fairly uniform response up to their limiting frequency. As a result, the designer of an amplifier with a triode output stage need not consider the impedance versus frequency characteristics of the loudspeaker, but only the response.

The ratio of the nominal load resistance R_L to the output resistance R_0 of the amplifier is not unimportant. If R_L/R_0 is very high, the loudspeaker is being operated with nearly constant voltage at all frequencies. If R_L/R_0 is around 2 or 3, the voltage applied to the loudspeaker is slightly greater at frequencies where the loudspeaker impedance rises—this is generally an advantage. See also Chapter 13 Sect. 2(iv).

Pentodes without feedback are very critical with regard to load impedance [Chapter 13 Sect. 3(viii)]. Steps which may be taken to minimize the serious distortion include :

(1) The choice of a loudspeaker with a smaller variation of impedance with frequency, at least over the low frequency range [Chapter 20 Sect. 1(v)].

(2) Shunting the load by a capacitance, or a capacitance in series with a resistance, to reduce the impedance somewhat at high audio frequencies [Chapter 13 Sect. 3(viii)]. However, if the capacitance is sufficient to reduce the impedance to a more or less horizontal curve, there will inevitably be attenuation of the higher frequencies.

(3) Shunting the load by an inductance, through the use of a fairly low inductance of the transformer primary [Chapter 5 Sect. 3(iii)c ; Chapter 13 Sect. 3(vii), (viii)]. This only affects the low frequency peak, and is undesirable because of the resultant distortion.

(4) The use of a vented baffle to reduce the low frequency impedance peak [Chapter 20 Sect. 3(iv)].

(5) The selection of a loudspeaker impedance at 400 c/s rather lower than the nominal value, so that there is a variation on both sides of the nominal value instead of only on the upper side [Chapter 13 Sect. 3(viii)].

(6) The selection of an output valve capable of giving considerably more—say 3 times—the desired power output, so as to reduce the distortion with an incorrect load impedance.

(7) The use of negative voltage feedback (see below).

Fortunately, owing to the characteristics of music, the input voltage applied to the grid of the power amplifier at high frequencies will normally be less than the maximum. This somewhat reduces the distortion at high frequencies.

Pentodes with negative voltage feedback, when operated well below maximum power output, are less affected by the loudspeaker impedance variations than pentodes without feedback. If the feedback is large, the output voltage remains nearly constant irrespective of the loudspeaker. There is an optimum value of amplifier output resistance to give most nearly uniform response at all frequencies with any one loudspeaker.

When operated at maximum power output with the small degree of feedback usual in radio receivers, the load resistance is critical. Satisfactory operation with low distortion can only be obtained by reducing the grid input voltage.

With a large amount of feedback, as for a cathode follower, the impedance at 400 c/s should be the nominal value for the valve. The increase of impedance at other frequencies will not then cause distortion. See also Chapter 7 Sect. 5(iv).

SECTION 2 : MULTIPLE AND EXTENSION LOUDSPEAKERS

(i) *Multiple loudspeakers—general* (ii) *Sound systems* (iii) *Extension loudspeakers*
(iv) *Operation of loudspeakers at long distances from amplifier.*

(i) Multiple loudspeakers—general

Two or more loudspeakers may be connected to a single amplifier either to reinforce the sound in a large space, or to give a pseudo-stereophonic effect. In all normal cases the loudspeakers will each handle the whole frequency range and operate at approximately the same level. The usual arrangement is to connect the loudspeakers in parallel either on the primary or secondary side. In the former case an a-f choke may be used in the plate circuit with capacitive coupling to the transformer primaries (Fig. 21.1). If the correct load resistance is R_L , the nominal impedance of T_1 and T_2 should each be $2R_L$. If there are N loudspeakers in parallel, each should have a nominal impedance of NR_L . The value of C_1 may be calculated as a coupling condenser [Chapter 12 Sect. 2(ii)] into a resistance R_L . If $R_L = 5000$ ohms, C_1 may be $1\mu\text{F}$ for about 1 db loss at 60 c/s. The value of L_1 may be calculated as for an a-f transformer [Chapter 5 Sect. 3(iii)c and Table 2 p. 213]. The total attenuation is the sum of that due to L_1 , the coupling condenser C_1 and the transformer T_1 . A suitable value for L_1 is normally from 10 to 30 henrys.

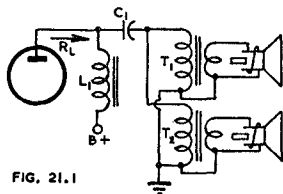

FIG. 21.1

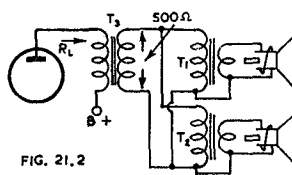

FIG. 21.2

Fig. 21.1. Choke-capacitance coupling to two or more loudspeakers in parallel.

Fig. 21.2. Transformer coupling to 500 ohm line, across which two or more loudspeakers are connected in parallel.

Alternatively the parallel loudspeakers may be connected across a 500 ohm (or any other convenient value) line from the secondary of transformer T_3 as in Fig. 21.2. Here T_3 will have a 500 ohm secondary and will reflect an impedance R_L into the primary. T_1 and T_2 will have nominal impedances each 1000 ohms. If there are N loudspeakers in parallel, each will have a nominal impedance of $N \times 500$ ohms.

The simplest arrangement is to connect the secondaries in parallel as for extension loudspeakers (Fig. 21.5).

Loudspeakers may also be connected in series or in series-parallel, provided that the units are identical, with identical impedances. If loudspeakers having different impedances are connected in parallel, the power output from each will be inversely proportional to its impedance—

Loudspeaker No. 1.	Impedance R_1	Power output P_1
Loudspeaker No. 2	Impedance R_2	Power output P_2

Connected in parallel with applied voltage E :

$$P_1 = E^2/R_1; P_2 = E^2/R_2 \text{ etc. for any number.}$$

If it is desired to operate two loudspeakers with power outputs in the ratio A to 1, where A is greater than 1 :

$$P_1/P_2 = A; R_2/R_1 = A$$

The impedance of the two in parallel will be

$$R = R_1 R_2 / (R_1 + R_2).$$

Example : A monitor loudspeaker is to operate with an input power of 1 watt and is to be connected across a combined loudspeaker load of 30 watts with a total (line) impedance of 500 ohms. The ratio of power is 30 : 1 so that the impedance of the monitor loudspeaker (measured across the primary of its transformer) should be $30 \times 500 = 15\,000$ ohms. In this case the monitor will have negligible effect on the combined impedance.

(ii) Sound systems

In medium and large installations it is convenient to design amplifiers for a constant output voltage. The usual output voltage in U.S.A. is 70.7 volts but higher voltages 100, 141, 200 etc. are also used (R.M.A. SE-101-A, July 1949, SE-106, July 1949). Each amplifier normally has its own distribution line suitably loaded by loudspeakers. Each loudspeaker may be arranged—by the use of transformer tappings—to take from the line any desired power, while any loudspeaker may be moved from one line to another without affecting its output level. If the loudspeaker transformers are correctly matched to the voice coil impedance and the line voltage, the matching of the whole distribution line to the amplifier will be correct when the line is loaded to the full capabilities of the amplifier.

The American Standard (R.M.A. SE-106) specifies transformer secondary impedances of 4, 8 or 16 ohms ; this does not apply to transformers which are furnished only as part of a loudspeaker. The primaries are tapped to provide output power levels of 1 watt and proceeding upwards and downwards in 3 db steps (i.e. 1, 2, 4 watts etc., 0.5, 0.25 etc.) when the standard input voltage is applied.

(iii) Extension loudspeakers

An extension loudspeaker is one which may be added to the existing loudspeaker in a radio receiver, for which provision may or may not be made by the set manufacturer.

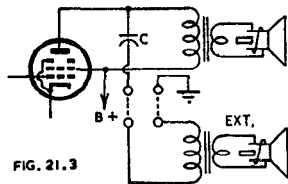

FIG. 21.3

Fig. 21.3. Common form of extension loudspeaker.

The most common provision for an extension loudspeaker is shown in Fig. 21.3 in which the extension loudspeaker (marked "EXT") is fed through a blocking condenser connected to the plate of the power valve. It is necessary for the user to arrange for flexible leads to be taken from two terminals on the chassis, across the primary of the stepdown transformer, to the permagnetic extension speaker. If the extension speaker has the same reflected load impedance as the transformer of the original speaker,

the power output will be shared equally between the two, but the impedance of the two speaker primaries in parallel will be only half what it should be for maximum power output. If no provision is made to provide correct matching, the arrangement will be quite practical, except that the power output of both speakers together will be less than with correct matching.

An alternative arrangement, which has much to commend it, is the use of an extension speaker with an impedance of about twice that of the speaker in the set. This means that the extension speaker will operate at a lower sound level than the one in the set, but the mis-matching will be less severe and the maximum volume obtainable from the set will not be seriously affected.

If negative feedback is used in the receiver, the effect of the connection of the external speaker on the volume level of the loudspeaker in the set will not be very noticeable at low or medium levels, although the same problem arises in regard to the overload level.

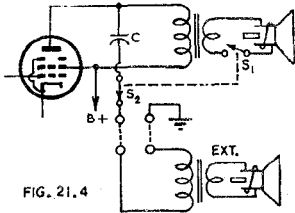

FIG. 21.4

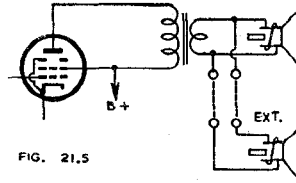

FIG. 21.5

Fig. 21.4. Extension loudspeaker with provision for switching either loudspeaker alone.

Fig. 21.5. Extension loudspeaker connected to the voice coil circuit.

It is possible to modify the previous arrangement by means of switches which can open-circuit the voice coil of the first speaker and at the same time close a switch in the primary circuit of the second speaker. This is illustrated in Fig. 21.4 from which it will be seen that only one speaker will be operating at the one time and there is therefore no problem with correct matching. With this arrangement, the extension speaker should have the same impedance as the one in the set and the power input to both speakers will then be equal. The two switches S_1 and S_2 could, of course, be combined into a single wafer switch.

The previous arrangements have all adopted an extension from the primary of the loud speaker transformer and therefore at a high impedance. There are advantages to be gained in using the voice-coil circuit for the extension, as illustrated in Fig. 21.5. This avoids the necessity for a step-down transformer on the extension speaker and for a blocking condenser. The set manufacturer may fit two terminals on the loudspeaker housing, connected to the voice coil, as an alternative to Fig. 21.3. To obtain the same power from both speakers, it is necessary for the voice-coil impedances to be equal. If it is required to have one speaker operating at a higher level of sound than the other, the impedance of the second (lower output) speaker should be made higher than that of the first speaker. In such a case it is possible to obtain correct matching by calculating the impedance of both voice-coils in parallel and selecting a step-down transformer to suit. Very few voice-coils have an impedance less than about 2 ohms, so that it is possible to use quite ordinary wiring in the connections of the extension speaker. If the second speaker is to be situated more than say 10 feet from the first speaker, it may be desirable to use heavy wire, such as power flex (twin plastic is very convenient). In some cases it may be desired to operate the extension speaker at a rather lower level than the first speaker, in which case losses in the extension line may be desirable.

A single-pole double-throw switch may be used to change over from one to the other voice-coil as shown in Fig. 21.6 (A). Here switch S is used to open-circuit the first voice-coil and at the same time to close the circuit to the second voice-coil. The further refinement of a series volume control R is shown in the extension speaker circuit, so that the volume may be reduced below that of the speaker in the receiver. The resistance R should have a maximum value about 20 times that of the voice-coil impedance, but even so this arrangement cannot be used to reduce the volume to zero.

In order to have a complete control over the volume from the extension loudspeaker, the arrangement of (B) may be used in which R is a potentiometer with the moving contact taken to the extension speaker.

when one speaker only is operating. Only half the full power output is available when one speaker is operating alone ; the full power output is, however, available when both speakers are operating together (switch position 1). This has the result that the switching in of the second speaker does not affect the volume level of the first speaker, the resistor R really being a dummy load to take the power which would otherwise be supplied to the second speaker. The two switches S_1 and S_2 may be made from a single wafer wave-change switch.

A preferred arrangement, which does not result in any power loss under any circumstances, is the use of a tapped secondary winding on the transformer. The full winding on the secondary is used for one or other loudspeaker, while the tap is used for both operating together ; this involves a more elaborate switching arrangement but one which may be justified in certain circumstances.

The use of an appreciable amount of negative voltage feedback results in nearly constant voltage across the load under all conditions, and minimizes changes in volume level with any form of switching.

When the loudspeaker is some distance from the transformer secondary, the power loss in the connecting wiring should not exceed 15%.

Line length for 15% line power loss in low impedance lines :

Wire size		Load Impedance (Ohms)					
A.W.G.	S.W.G.	2	4	6	8	10	15
14	16	60 ft.	120 ft.	180 ft.	240 ft.	300 ft.	450 ft.
16	18	38 ft.	75 ft.	113 ft.	150 ft.	190 ft.	285 ft.
18	19	23 ft.	47 ft.	70 ft.	95 ft.	118 ft.	177 ft.
20	21	15 ft.	30 ft.	45 ft.	60 ft.	75 ft.	112 ft.
22	23	9 ft.	18 ft.	28 ft.	37 ft.	47 ft.	70 ft.

Reference 20.

(iv) Operation of loudspeakers at long distances from amplifier

When one or more loudspeakers are to be operated at a considerable distance from the amplifier, it is usual to have at the amplifier a transformer to step-down, for example, to a 500 ohm "line" which may be in the form of ordinary electric power wiring for distances up to several thousand feet. At the far end there must be another step-down transformer from 500 ohms to the correct impedance to match the voice coil circuit impedance. In such a case the "line" does not itself impose any appreciable load ; the loudspeaker impedance is reflected back through the transformer to load the line.

Line length for 15% line power loss in 500 ohm lines :

Wire size (A.W.G.)	19	21	23	25
Wire size (S.W.G.)	20	22	24	26
Length of line (feet)	4750	2880	1780	1500

Although 500 ohms is a popular value, any lower or higher value may be used provided that the resistance of the line is not too great, and that the capacitance across the line does not seriously affect the high frequency response.

A very popular line impedance is 600 ohms.

SECTION 3: LOUDSPEAKER DIVIDER NETWORKS

When two loudspeakers are used in a 2 way system, it is necessary to have a frequency dividing network. The attenuation characteristic may have an ultimate slope of 6, 12 or 18 db per octave, but the most generally satisfactory compromise is 12 db per octave. A slope of 6 db per octave is usually insufficient to prevent overloading of the high frequency unit at frequencies below the cross-over frequency.

The theory of frequency dividing networks is covered in Chapter 4 Sect. 8(x). The simplest possible arrangement is Fig. 4.53A for which the values of L_0 and C_0 are given on page 184 for known values of R_0 and the cross-over frequency f_c . In order to obtain reasonably satisfactory performance, the high-frequency unit should be a fairly substantial 5 in. or larger loudspeaker, and the cross-over frequency should preferably be between 800 and 1200 c/s. The high frequency response will obviously be restricted. The low frequency unit should have reasonable response up to about 2000 c/s. One of the most popular arrangements for good fidelity is the series-connected constant-resistance type of Fig. 4.53B giving an ultimate attenuation of 12 db. Both inductors and both capacitors have identical values. Here $L_1 = R_0/(2\sqrt{2}\pi f_c)$ and $C_1 = 1/(\sqrt{2}\pi f_c R_0)$. For example, let the voice coil impedance R_0 be 10 ohms, and the cross-over frequency 800 c/s.

Then $L_1 = 10/(2 \times 1.41 \times \pi \times 800) = 1.41$ millihenrys
and $C_1 = 1/(1.41 \times \pi \times 800 \times 10) = 28.2 \mu\text{F}$.

The parallel-connected constant resistance type is also used (Ref. 21).

Air cored multilayer solenoids may be used for inductances up to 8 millihenrys. Suitable sizes of formers are $1\frac{1}{2}$ in. dia., with axial length $\frac{3}{4}$ in. for inductances from 0.5 to 2.0 mH and $1\frac{1}{4}$ in. for inductances from 2.0 to 8.0 mH. The winding wire may be 17 A.W.G. (18 S.W.G.) double cotton enamelled copper. The outside diameter will be less than 4 in. for the values quoted above.

FIG. 21.8

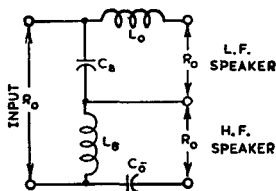

Fig. 21.8. Filter type frequency dividing network, series connection.

The number of turns may be calculated from the formulae of Chapter 10 Sect. 2(iv)A or alternatively from curves (Ref. 11 for 17 A.W.G. D.C.E.).

Iron cores introduce distortion, and are therefore undesirable. However if iron-cored inductors are used, an air gap of 0.008 in. or 0.010 in. should be provided (Ref. 6 p. 101). Ferrite cores present possibilities for this application.

In the filter type arrangement which is also popular, the two inductors and the two capacitors have different values, and the nominal attenuation is 12 db per octave (Fig. 21.8). Taking the design constant $m = 0.6$, we have

$$L_0 = R_0/(2\pi f_c) \qquad C_0 = 1/(2\pi f_c R_0)$$

$$L_b = R_0/(3.2\pi f_c) \qquad C_s = 0.8/(\pi f_c R_0)$$

where L is in henrys and C is in farads (Refs. 6, 19).

In all cases the series connection is preferable to the parallel connection. Resistance in the inductors has a slight effect on the attenuation at the cross-over frequency, while it also introduces insertion loss (0.3 to 1 db). Care should be taken to keep the resistance as low as practicable. The usual position is between a single power amplifier valve (or two in push-pull or parallel) and the loudspeakers. The insertion loss is therefore a loss of maximum output power. The divider network may be connected either on the primary or secondary side of the output transformer, the latter being more usual—in this case the transformer must be suitable for the total frequency range of both units.

If the dividing network is placed on the primary side, each of the two output transformers is only called upon to handle a limited frequency range, and may be of cheaper construction. One interesting application is Fig. 21.9 (Refs. 9, 16). For a plate-to-plate load of 5000 ohms and a cross-over frequency of 400 c/s the component values are :

$L_1 = 2.0$ henrys (series aiding) ; inductance T_1 primary = 50 henrys min. ;
 $L_2 = 1.0$ henry (with air gap) ; T_2 primary inductance = 2.0 henrys (with air gap) ;
 $C_1 = 0.16 \mu\text{F}$; $C_2 = 0.04 \mu\text{F}$; leakage inductance of T_1 not over 1 henry ;
 leakage inductance of T_2 not over 0.05 henry.

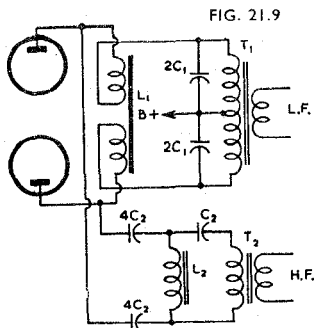

FIG. 21.9

Fig. 21.9. Alternative form of divider network using two stepdown transformers (Ref. 9).

It has been shown that the arrangement of Fig. 21.9 produces less distortion than the conventional circuit : this is due to two features. Firstly, the low-pass filter $L_1, 2C_1$ attenuates high frequencies propagating in either direction ; as a result the harmonic components of magnetizing current in T_1 have less effect on the high-pass channel. Secondly, the low-pass filter attenuates high frequencies on their way to T_1 so that the transformer is only called upon to handle a limited range of frequencies, thereby reducing the distortion (Ref. 9).

In the case of separate amplifiers for low and high audio frequencies, the divider network preferably precedes the amplifiers. This permits separate attenuators to be used for each channel ; these may be used for balancing the two units, or for tone control.

If the high frequency unit is more sensitive than the low frequency one, a simple form of fixed attenuator may be incorporated (Fig. 21.10). Here

$$R_1 + R_3 = R_0 \text{ and } R_1/R_3 = (E_1/E_2) - 1$$

where $R_3 = R_2 R_0 / (R_2 + R_0)$.

For example, to give $(E_1/E_2) = 2$ (i.e. an attenuation of 6 db) :
 $R_1 = \frac{1}{2}R_0$ and $R_2 = R_0$.

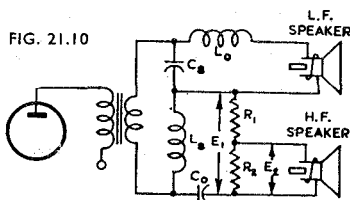

FIG. 21.10

Fig. 21.10. Complete circuit from valve plate to loudspeakers, incorporating the filter of Fig. 21.8 with an attenuator on the h. f. speaker.

If it is desired to use this as a variable attenuator to give tone control, it should preferably be of the constant input impedance type such as the L pad [Fig. 21.11, also see Chapter 18 Sect. 3(iii)]. If a simpler type must be used, it may be designed as for Fig. 21.10 to give the correct input impedance at the normal operating position, but with a sliding contact. It will then have an incorrect impedance at any other

setting ; the effect is only slight if the sensitivity of this unit is very much greater than the other, as happens with horn and direct-radiator assemblies.

If one loudspeaker unit has a lower impedance than the other, an auto-transformer may be used to provide correct matching. This may not be necessary if an attenuator is used on one unit.

FIG. 21.11

Fig. 21.11. *L* type level control providing constant input resistance.

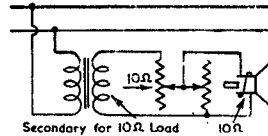

It is important to check for the phasing of the two loudspeakers ; in the vicinity of the cross-over frequency both units should be in phase (aiding one another). This may be checked by the use of a single dry cell connected in series with the secondary of the transformer ; in the case of 2 ohm voice coils there may be a 5 ohm limiting resistor connected in series with the cell.

References 1, 2, 6, 9, 11, 12, 16, 19, 21, 22, 24, 25, 26.

SECTION 4 : REFERENCES

1. Sowerby, J. McG. "Radio Data Charts 10—loudspeaker dividing networks" W.W. 49.8 (Aug. 1943) 238.
2. Sieder, E. N. "Design of crossover networks for loudspeaker units" Q.S.T. 28.12 (Dec. 1944) 35.
4. "Matching transformers for loudspeakers" Philips Tec. Com. 78 (Nov.-Dec. 1940) and 79 (Jan.-Feb. 1941).
5. Stanley, A. W. "The output stage—effect of matching on frequency response" W.W. 52.8 (Aug. 1946) 256.
6. Terman, F. E. "Radio Engineers' Handbook" (McGraw-Hill Book Company, New York and London, First edition 1943) pp. 249-251.
7. Langford-Smith, F. "The relationship between the power-output stage and the loudspeaker" A.W.A. Tec. Rev. 4.4 (Feb. 1940) 199. Originally published in Proceedings of World Radio Convention, Sydney, April 1938 (Institution of Radio Engineers, Australia). See also Ref. 7a.
- 7a. Langford-Smith, F. "The output stage and the loudspeaker" W.W. 44.6 (Feb. 9, 1939) 133 ; 44.7 (Feb. 16, 1939) 167.
8. R.C.A. "Application Note on receiver design—output transformer" (variation of impedance with current) No. 75 (May 28, 1937).
9. Klipsch, P. W. "Low distortion cross-over network" Elect. 21.11 (Nov. 1948) 98.
10. Langford-Smith, F. "The design of a high fidelity amplifier—(1) The power valve and the loudspeaker," Radiotronics 124 (March-April 1947) 25. (2) "Negative feedback beam power amplifiers and the loudspeaker," Radiotronics 125 (May-June 1947) 53.
11. McProud, C. G. "Design and construction of practical dividing networks" Audio Eng. 31.5 (June 1947) 15.
12. Schuler, E. R. "Design of loudspeaker dividing networks" Elect. 21.2 (Feb. 1948) 124.
13. McProud, C. G. "Two-way speaker system" Part 3 Audio Eng. 32.2 (Feb. 1948) 21.
14. Angevine, O. L. "Impedance matching" Audio Eng. 31.11 (Dec. 1947) 20.
15. Jonker, J. L. H. "Pentode and tetrode output valves" Philips Tec. Com. 75 (July 1940) 1.
16. Klipsch, P. W. "Woofer-tweeter crossover network" Elect. 18.11 (Nov. 1945) 144.
18. Amos, S. W. "Feedback and the loudspeaker" W.W. 50.12 (Dec. 1944) 354.
19. Hilliard, J. K. "Loudspeaker dividing networks" Elect. 14.1 (Jan. 1941) 26.
20. "Impedance matching and power distribution in loud speaker systems" Technical Monograph No. 2, Jensen Radio Mfg. Co.
21. Smith, B. H. "Constant-resistance dividing networks" Audio Eng. 35.8 (Aug. 1951) 18.
22. White, S. "Design of crossover networks" FM-TV 12.1 (Jan. 1952) 42.

Additional references will be found in the Supplement commencing on page 1475.