

Beam Power Tube

FORCED-AIR COOLED
THORIATED-TUNGSTEN FILAMENT
10-KW PLATE DISSIPATION IN CW OR TV SERVICE UP TO 220 Mc

COAXIAL-ELECTRODE STRUCTURE
INTEGRAL RADIATOR

GENERAL DATA

Electrical:

Filament, Multistrand Thoriated Tungsten:		
Voltage (AC or DC) ^a	5 ± 5%	volts
Current at 5 volts.	181	amp
Minimum heating time.	15	sec
Cold resistance	0.0038	ohm
Mu Factor, Grid No.2 to Grid No.1 for plate volts = 2000, grid-No.2 volts = 1000, and plate amperes = 2		
	10	
Direct Interelectrode Capacitances:		
Grid No.1 to plate ^b	0.6 max.	μμf
Grid No.1 to filament	42	μμf
Plate to filament ^b	0.08 max.	μμf
Grid No.1 to grid No.2.	60	μμf
Grid No.2 to plate.	24	μμf

Mechanical:

Operating Position.	Vertical, filament end up or down
Maximum Overall Length.	11.63"
Maximum Diameter.	6.38"
Weight (Approx.).	15 lbs
Radiator.	Integral part of tube
Terminal Connections (See <i>Dimensional Outline</i>):	

G₁ - Grid No.1
G₂ - Grid No.2

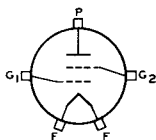

P - Plate
F - Filament

Air Flow:

Through radiator—The specified flow of incoming air at a temperature of 45° C for various plate dissipations, as indicated in the tabulation below, should be delivered by a blower through the radiator before and during the application of any voltages. The air should enter the radiator at its plate-terminal end (See *Dimensional Outline*). Filament power, plate power, grid-No.2 power, and air flow may be removed simultaneously.

Percentage of maximum-rated plate dissipation for each class of service.	100	80	60	%
Minimum air flow.	350	270	200	cfm
Static pressure	3	2.1	1.3	in. of water

← Indicates a change.



RADIO CORPORATION OF AMERICA
Electron Tube Division
Harrison, N. J.

DATA 1
5-61

To grid-No.2 terminal	50 min.	cfm
To grid-No.1 terminal and filament terminals.	50 min.	cfm
Incoming-Air Temperature.	45 max.	°C
Radiator Temperature (Measured on the core at end away from incoming air) . .	180 max.	°C
Glass Temperature (At hottest point). . .	180 max.	°C
Seal Temperature:		
Filament, grid No.1, grid No.2, and plate	180 max.	°C

RF POWER AMPLIFIER — Class B Television Service

*Synchronizing-level conditions per
tube unless otherwise specified*

(Voltages are referred to cathode unless otherwise specified)

Maximum CCS^c Ratings, Absolute-Maximum Values:

	<i>54 to 216 Mc</i>	
DC PLATE VOLTAGE.	6000 ^d max.	volts
DC GRID-No.2 (SCREEN-GRID) VOLTAGE. . . .	2000 max.	volts
DC PLATE CURRENT.	4 max.	amp
PLATE INPUT	22000 ^d max.	watts
GRID-No.2 INPUT	400 max.	watts
PLATE DISSIPATION	10000 max.	watts
GRID-No.1 (CONTROL-GRID) DISSIPATION. . .	300 max.	watts

→ Typical Operation in Grid-Drive Circuit at 216 Mc:

	<i>Bandwidth^e of 8.5 Mc</i>	
DC Plate Voltage.	5800	volts
DC Grid-No.2 Voltage.	1200	volts
DC Grid-No.1 Voltage.	-130	volts
Peak RF Grid-No.1 Voltage:		
Synchronizing level	375	volts
Pedestal level.	290	volts
DC Plate Current:		
Synchronizing level	3.45	amp
Pedestal level.	2.6	amp
DC Grid-No.2 Current (Pedestal level) . .	0.207	amp
DC Grid-No.1 Current (Approx.):		
Synchronizing level	0.175	amp
Pedestal level.	0.085	amp
Driver Power Output (Approx.): ^f		
Synchronizing level	800 ^g	watts
Pedestal level.	450	watts
Useful Power Output (Approx.):		
Synchronizing level ^h	12000	watts
Pedestal level.	6800	watts

→ Typical Operation in Cathode-Drive Circuit at 216 Mc:

	<i>Bandwidth^e of 8.5 Mc</i>	
DC Plate-to-Grid-No.1 Voltage	5885	volts
DC Grid-No.2-to-Grid-No.1 Voltage	885	volts

→ Indicates a change.



DC Cathode-to-Grid-No.1 Voltage	85	volts
Peak RF Cathode-to-Grid-No.1 Voltage:		
Synchronizing level	330	volts
Pedestal level.	260	volts
DC Plate Current:		
Synchronizing level	3.45	amp
Pedestal level.	2.6	amp
DC Grid-No.2 Current (Pedestal level) . .	0.152	amp
DC Grid-No.1 Current (Approx.):		
Synchronizing level	0.202	amp
Pedestal level.	0.11	amp
Driver Power Output (Approx.): ^h		
Synchronizing level	1300 ^j	watts
Pedestal level.	700	watts
Useful Power Output (Approx.):		
Synchronizing level	12000	watts
Pedestal level.	6800	watts

GRID-MODULATED RF POWER AMPLIFIER
Class C Television Service

*Synchronizing-level conditions per
tube unless otherwise specified*

Maximum CCS^c Ratings, Absolute-Maximum Values:

	<i>54 to 216 Mc</i>	
DC PLATE VOLTAGE.	6000 max.	volts
DC GRID-No.2 (SCREEN-GRID) VOLTAGE. . . .	2000 max.	volts
DC GRID-No.1 (CONTROL-GRID) VOLTAGE (White level)	-1000 max.	volts
DC PLATE CURRENT.	4 max.	amp
PLATE INPUT	22000 max.	watts
GRID-No.2 INPUT	400 max.	watts
PLATE DISSIPATION	10000 max.	watts
GRID-No.1 DISSIPATION	300 max.	watts

Typical Operation in Grid-Drive Circuit at 216 Mc: ←

	<i>Bandwidth^e of 8.5 Mc</i>	
DC Plate Voltage.	5800	volts
DC Grid-No.2 Voltage.	1200	volts
DC Grid-No.1 Voltage:		
Synchronizing level	-130	volts
Pedestal level.	-195	volts
White level	-350	volts
Peak RF Grid-No.1 Voltage	375	volts
DC Plate Current:		
Synchronizing level	3.45	amp
Pedestal level.	2.42	amp
DC Grid-No.2 Current (Pedestal level) . .	0.148	amp
DC Grid-No.1 Current (Approx.):		
Synchronizing level	0.175	amp
Pedestal level.	0.095	amp

← Indicates a change.



Bandwidth^e of 8.5 Mc

Driver Power Output (Approx.): ^f		
Synchronizing level	800 ^g	watts
Pedestal level.	425	watts
Useful Power Output (Approx.):		
Synchronizing level	12000	watts
Pedestal level.	6800	watts

LINEAR RF POWER AMPLIFIER

Single-Sideband Suppressed-Carrier Service

Maximum CCS^c Ratings, Absolute-Maximum Values:

	<i>Up to 60 Mc</i>	
DC PLATE VOLTAGE.	6900	max. volts
DC GRID-No.2 (SCREEN-GRID) VOLTAGE.	2000	max. volts
MAX.-SIGNAL DC PLATE CURRENT.	2.75	max. amp
MAX.-SIGNAL DC GRID-No.1 (CONTROL-GRID) CURRENT.	0.6	max. amp
MAX.-SIGNAL PLATE INPUT	18000	max. watts
MAX.-SIGNAL GRID-No.2 INPUT	400	max. watts
PLATE DISSIPATION	10000	max. watts

Typical CCS Class AB₁ and AB₂ "Single-Tone" Operation at 60 Mc:^k

	<i>Class</i>		
	<i>AB₁</i>	<i>AB₂</i>	
DC Plate Voltage.	6900	6500	volts
DC Grid-No.2 Voltage.	1200	1200	volts
DC Grid-No.1 Voltage ^m	-125	-125	volts
Zero-Signal DC Plate Current.	0.2	0.2	amp
Zero-Signal DC Grid-No.2 Current.	0	0	amp
Effective RF Load Resistance.	5400	1200	ohms
Max.-Signal DC Plate Current.	0.675	2.75	amp
Max.-Signal DC Grid-No.2 Current.	0.035	0.26	amp
Max.-Signal DC Grid-No.1 Current.	0	0.08	amp
Max.-Signal Peak RF Grid-No.1 Voltage	125	305	volts
Max.-Signal Driving Power (Approx.)	0	25	watts
Max.-Signal Power Output (Approx.)	2920	10600	watts

PLATE-MODULATED RF POWER AMPLIFIER — Class C Telephony

Carrier conditions per tube for use
with a maximum modulation factor of 1

Maximum CCS^c Ratings, Absolute-Maximum Values:ⁿ

DC PLATE VOLTAGE.	5000	max. volts
DC GRID-No.2 (SCREEN-GRID) VOLTAGE.	2000	max. volts
DC GRID-No.1 (CONTROL-GRID) VOLTAGE	-1000	max. volts
DC PLATE CURRENT.	2	max. amp
DC GRID-No.1 CURRENT.	0.6	max. amp
PLATE INPUT	10000	max. watts
GRID-No.2 INPUT	270	max. watts
PLATE DISSIPATION	6600	max. watts

→ Indicates a change.



Typical Operation in Grid-Drive Circuit:

	Up to 60 Mc		
DC Plate Voltage.	4700		volts
DC Grid-No.2 Voltage (Modulated 100%) ^d . . .	800		volts
DC Grid-No.1 Voltage ^e	-280		volts
Peak RF Grid-No.1 Voltage	485		volts
DC Plate Current.	1.56		amp
DC Grid-No.2 Current.	0.217		amp
DC Grid-No.1 Current (Approx.).	0.15		amp
Driver Power Output (Approx.) ^f	180 ^g		watts
Useful Power Output (Approx.)	5500		watts

RF POWER AMPLIFIER & OSCILLATOR — Class C Telegraphy^t
and
RF POWER AMPLIFIER — Class C FM Telephony

Maximum CCS^c Ratings, Absolute-Maximum Values:ⁿ

DC PLATE VOLTAGE.	6900	max.	volts
DC GRID-No.2 VOLTAGE.	2000	max.	volts
DC GRID-No.1 VOLTAGE.	-1000	max.	volts
DC PLATE CURRENT.	2.75	max.	amp
DC GRID-No.1 CURRENT.	0.6	max.	amp
PLATE INPUT	18000	max.	watts
GRID-No.2 INPUT	400	max.	watts
PLATE DISSIPATION	10000	max.	watts

Typical Operation in Grid-Drive Circuit:

	Up to 60 Mc		At 216 Mc		
DC Plate Voltage.	6400	5800	5800		volts
DC Grid-No.2 Voltage ^u	1200	1200	1200		volts
DC Grid-No.1 Voltage ^v	-310	-130	-175		volts
Peak RF Grid-No.1 Voltage	560	230	370		volts
DC Plate Current.	2.75	1.8	2.6		amp
DC Grid-No.2 Current.	0.3	0.1	0.267		amp
DC Grid-No.1 Current (Approx.).	0.14	0.05	0.11		amp
Driver Power Output (Approx.) ^f	75	300 ^w	750 ^x		watts
Useful Power Output (Approx.)	11600	6000	9000		watts

^a Full rated filament voltage can be applied safely to the cold filament. It is not necessary to provide means for limiting the filament starting current.

^b With external, flat, metal shield 12" square having center hole 4-5/16" diameter. Shield is located in plane of the grid-No.2 terminal, perpendicular to the tube axis, and is connected to grid No.2.

^c Continuous Commercial Service.

^d For operation on VHF television channels 2 through 6, DC plate voltage may be increased to 6400 max. volts and plate input may be increased to 24000 maximum watts provided all other ratings are met.

^e Computed between half-power points and based on tube output capacitance only.

^f The driver stage is required to supply tube losses and rf circuit losses. The driver stage should be designed to provide an excess of power above the indicated value to take care of variations in line voltage, in components, in initial tube characteristics, and in tube characteristics during life.

^g This value includes 700 watts of rf circuit loss at 216 Mc.

← Indicates a change.



- h The driver stage is required to supply tube losses, rf circuit losses, and rf power added to plate circuit. The driver stage should be designed as indicated under (f).
- j This value includes 300 watts of rf circuit loss at 216 Mc, and 900 watts added to plate circuit.
- k "Single-Tone Modulation" operation refers to that class of amplifier service in which the grid-No.1 input consists of a monofrequency rf signal having constant amplitude. This signal is produced in a single-sideband suppressed-carrier system when a single audio frequency of constant amplitude is applied to the input of the system.
- m Adjusted to give indicated zero-signal plate current.
- n These ratings hold for operation up to 60 Mc; for ratings at higher frequencies, see *Maximum Ratings vs Operating Frequency* table.
- p Obtained preferably from a separate source.
- r Obtained preferably from a combination of 365-ohm grid-No.1 resistor and -170-volt fixed bias.
- s This value includes 50 watts of rf circuit loss at 30 Mc.
- t Key-down conditions per tube without amplitude modulation. Modulation essentially negative may be used if the positive peak of the audio-frequency envelope does not exceed 115 per cent of the carrier conditions.
- u Obtained preferably from a separate source, or from the plate-supply voltage with a voltage divider, or through a series resistor. A series grid-No.2 resistor should not be used if the 6166 or a preceding stage is keyed. In this case, the regulation of the source should be sufficient to prevent the grid-No.2 voltage from rising above 2000 volts under key-up conditions; and additional fixed grid-No.1 bias must be provided to limit the plate current.
- v Obtained from fixed supply, by grid-No.1 resistor, by cathode resistor, or by combination methods.
- w This value includes 270 watts of rf circuit loss.
- x This value includes 675 watts of rf circuit loss.

CHARACTERISTICS RANGE VALUES FOR EQUIPMENT DESIGN

	Note	Min.	Max.	
Filament Current.	1	172	190	amp
Direct Interelectrode Capacitances:				
Grid No.1 to plate.	2	-	0.6	$\mu\mu\text{f}$
Grid No.1 to filament.	3	39	47	$\mu\mu\text{f}$
Grid No.1 to grid No.2.	3	52	64	$\mu\mu\text{f}$
Grid No.2 to plate.	3	21.2	25.8	$\mu\mu\text{f}$
Plate to filament.	2	-	0.08	$\mu\mu\text{f}$
DC Grid-No.1 Voltage.	1,4	-	-225	volts
Peak Grid-No.1 Current.	1,5	-	1.5	amp
Peak Grid-No.1 Voltage.	1,5	-	315	volts

Note 1: With 5 volts ac or dc on filament.

Note 2: With external, flat, metal shield 12" square having center hole 4-5/16" diameter. Shield is located in plane of the grid-No.2 terminal, perpendicular to the tube axis, and is connected to grid No.2. All other electrodes are grounded.

Note 3: Without shield and all other electrodes grounded.

Note 4: With dc plate voltage of 6000 volts, dc grid-No.2 voltage of 1200 volts, and dc plate current of 20 ma.

Note 5: With dc plate voltage of 1500 volts, dc grid-No.2 voltage of 1200 volts, and instantaneous grid-No.1 voltage adjusted to give peak plate current of 11 amp.

→ Indicates a change.



MAXIMUM RATINGS vs OPERATING FREQUENCY

FREQUENCY	60	220	Mc
MAXIMUM PERMISSIBLE PERCENTAGE OF MAXIMUM-RATED PLATE VOLTAGE AND PLATE INPUT:			
Class AB Single-Sideband Suppressed-Carrier Service	100	90	%
Class B Television Service	Full Ratings—54 to 216 Mc		
Class C Television Service	Full Ratings—54 to 216 Mc		
Class C Telephony, Plate-Modulated	100	90	%
Class C Telegraphy and FM Telephony	100	90	%

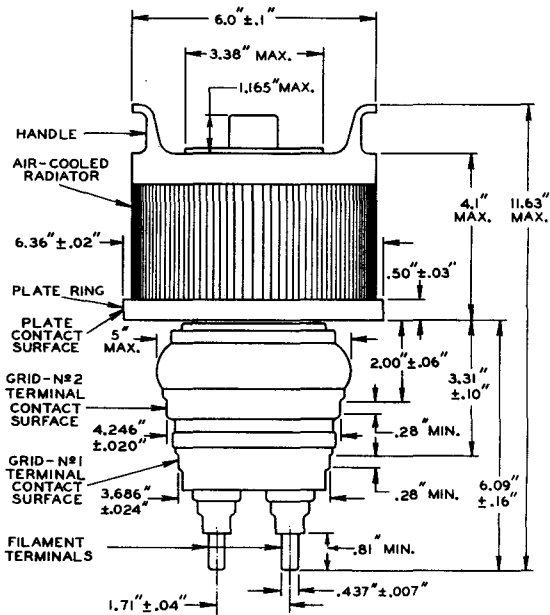

92CM-7716R2

← Indicates a change.



RADIO CORPORATION OF AMERICA
Electron Tube Division
Harrison, N. J.

DATA 4
5-61

WITH THE CYLINDRICAL SURFACES OF THE GRID-NO. 2 TERMINAL, GRID-NO. 1 TERMINAL AND THE FILAMENT TERMINALS CLEAN, SMOOTH, AND FREE OF BURRS, THE TUBE WILL ENTER A GAUGE AS SHOWN IN SKETCH G₁. THE FIVE CYLINDRICAL HOLES H₁, H₂, H₃, H₄, AND H₅ HAVE AXES THAT ARE COINCIDENT WITHIN 0.001" AND HAVE SUCCESSIVELY SMALLER DIAMETERS AS SHOWN. THE CENTER HOLES H₆ AND H₇ ARE LOCATED ON A DIAMETER WITHIN ± 0.001 " AND THEIR AXES ARE PARALLEL TO THE AXES OF H₁, H₂, H₃, H₄, AND H₅ WITHIN $0^\circ \pm 2'$.

THE PLATE RING WILL BE ENTIRELY ENGAGED BY HOLE H₁ AND WILL SEAT ON THE SHOULDER BETWEEN H₁ AND H₂. THE PLANE SURFACE OF THIS SHOULDER IS AT RIGHT ANGLES TO THE AXES OF THE HOLES WITHIN $0^\circ \pm 2'$. SEATING IS DETERMINED BY FAILURE OF A 0.020" THICKNESS GAUGE TO ENTER MORE THAN 1/16" BETWEEN SHOULDER SURFACE AND PLATE RING. SLOTS ARE PROVIDED TO PERMIT THIS MEASUREMENT.

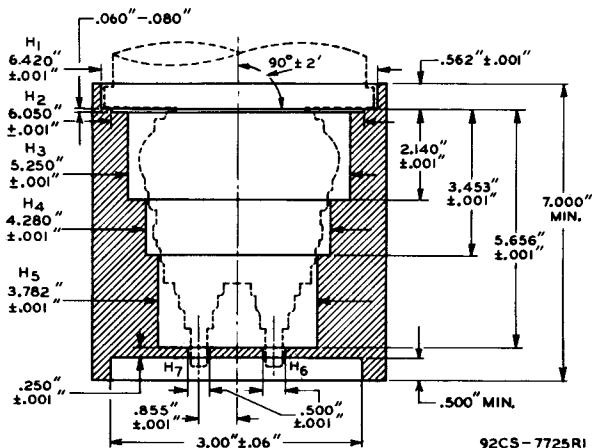
SKETCH G₁

COOLING REQUIREMENTS

 $E_f = 5$ VOLTS AC

MAXIMUM RADIATOR TEMPERATURE = 180° C

CURVE	PRESSURE DROP— INCHES OF WATER	CURVES TAKEN ACCORD- ING TO NAFM* STAND- ARDS—BULLETIN N° 103
A	1.3	*NATIONAL ASSOCIATION OF FAN MFGS., GENERAL MOTORS BLDG., DETROIT, MICH.
B	1.8	
C	2.4	
D	3	
E	3.7	
F	4.5	

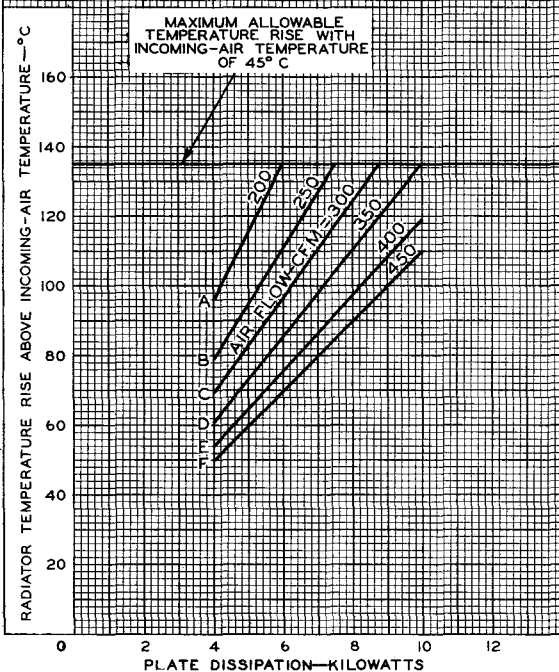

92CM-7728



AVERAGE PLATE CHARACTERISTICS



92CM-7736RI



AVERAGE CHARACTERISTICS

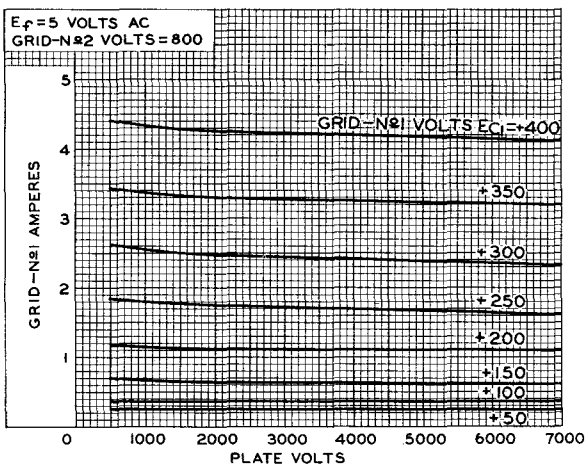

92CS-7744RI

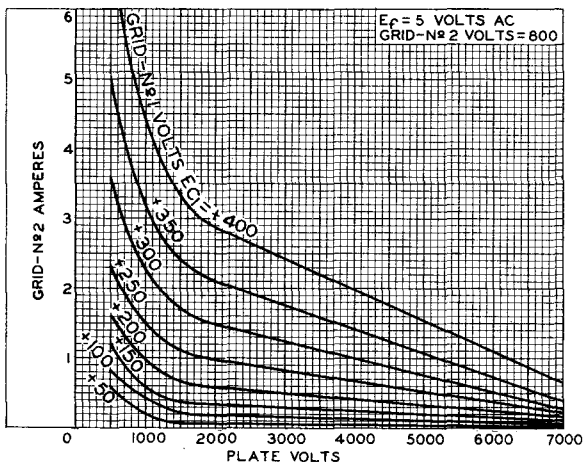

92CS-7743RI



AVERAGE CONSTANT-CURRENT CHARACTERISTICS

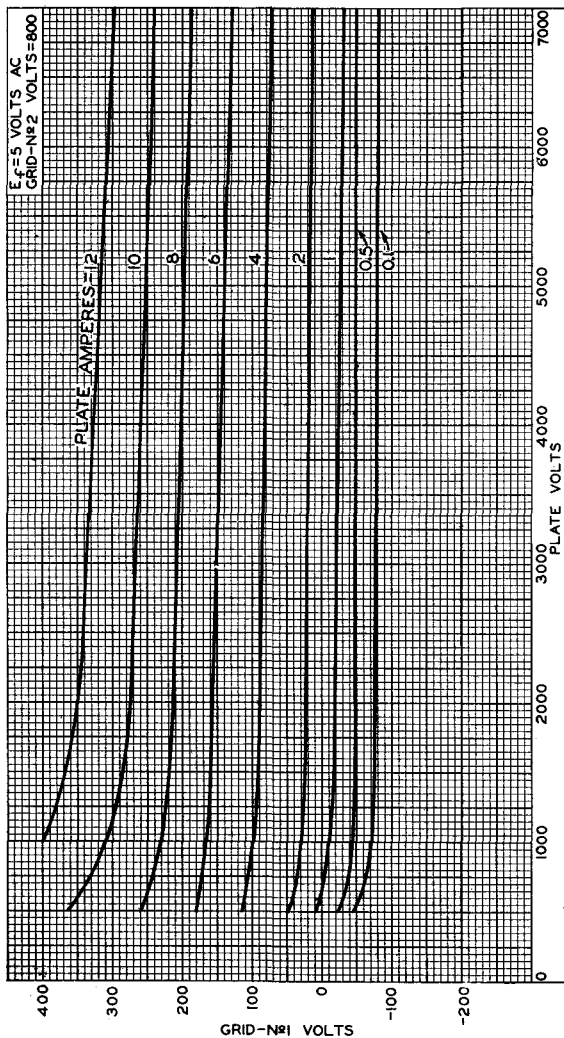

92CM-7737R1



AVERAGE CONSTANT-CURRENT CHARACTERISTICS

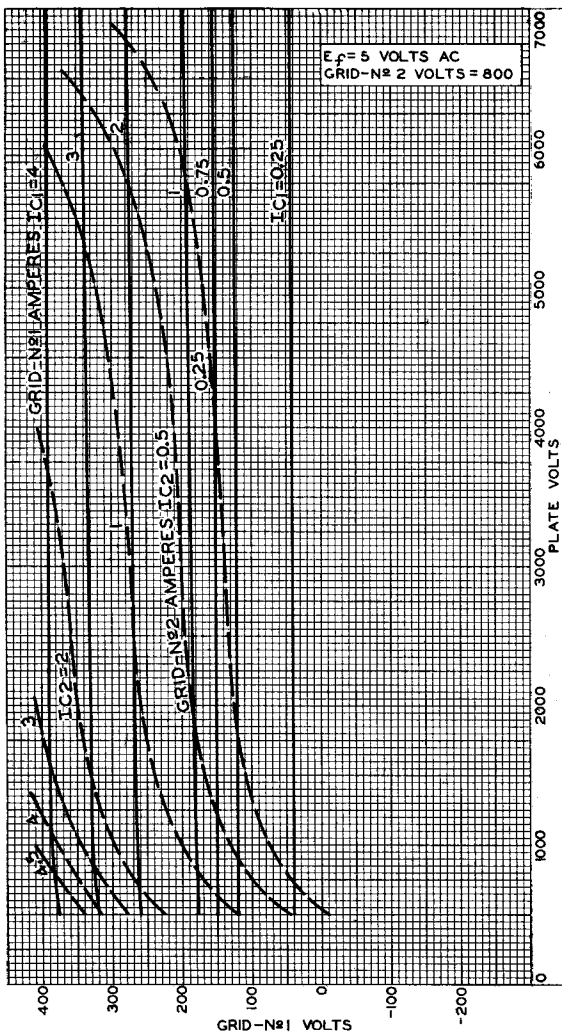

92CM-7738R2



RADIO CORPORATION OF AMERICA
 Electron Tube Division
 Harrison, N. J.

DATA 7
 5-61

AVERAGE PLATE CHARACTERISTICS

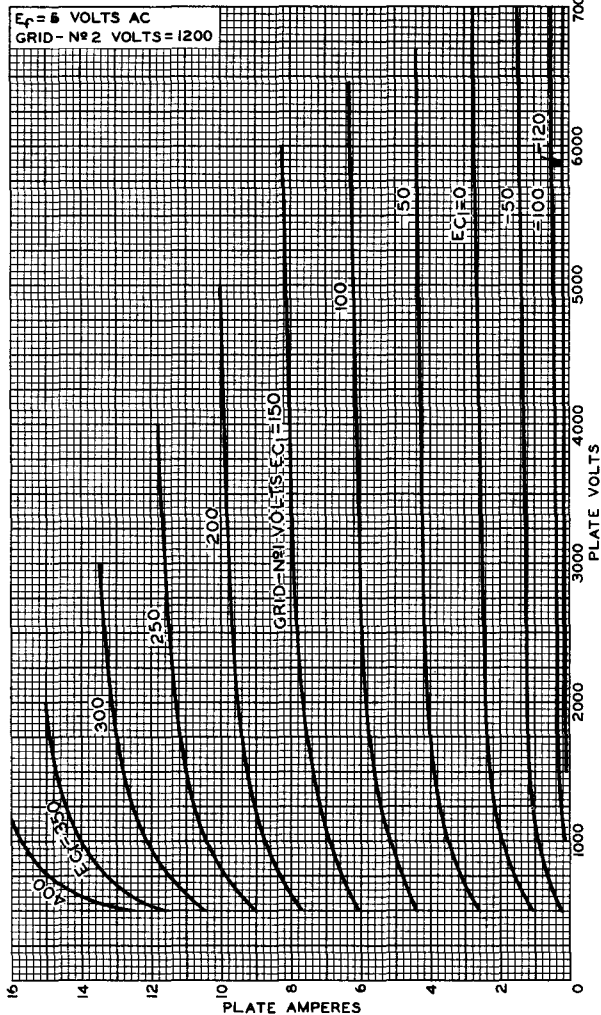

92CM-7735R1



AVERAGE CHARACTERISTICS

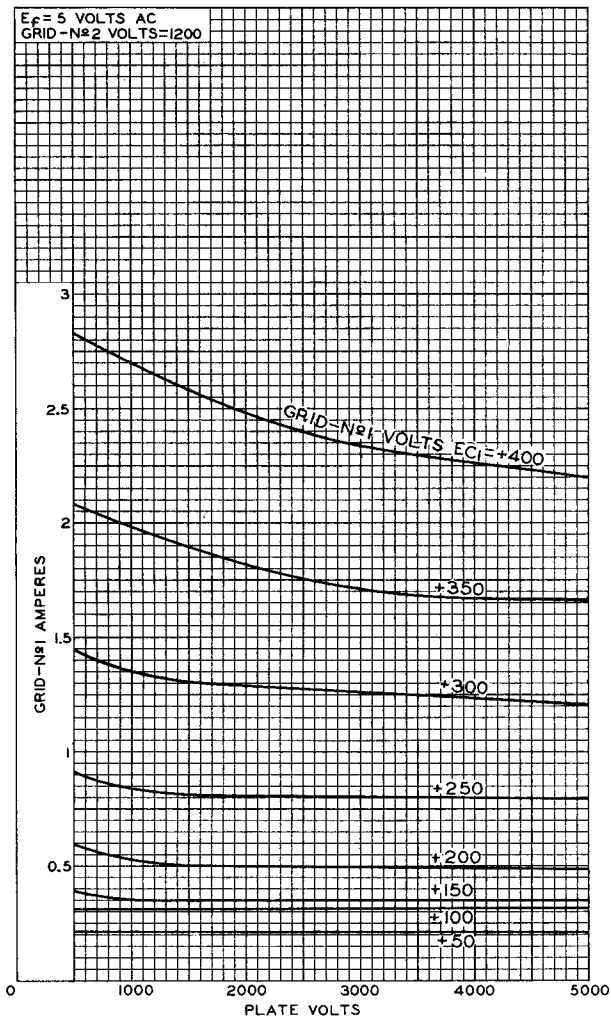

92CM-7740R2



RADIO CORPORATION OF AMERICA
Electron Tube Division
Harrison, N. J.

DATA 8
5-61

AVERAGE CHARACTERISTICS

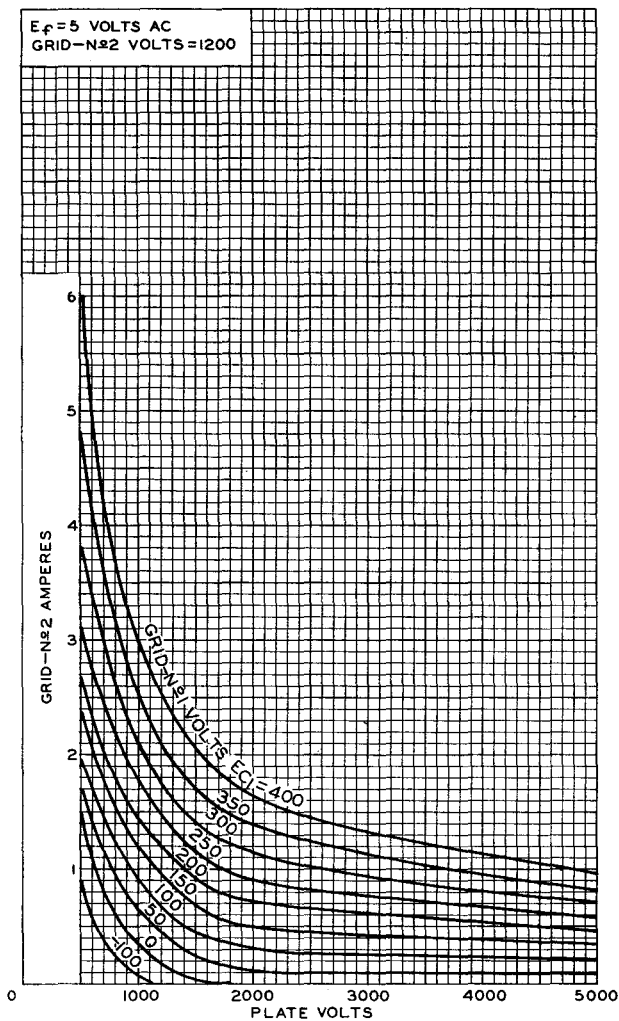

92CM-7739RI



AVERAGE CONSTANT-CURRENT CHARACTERISTICS

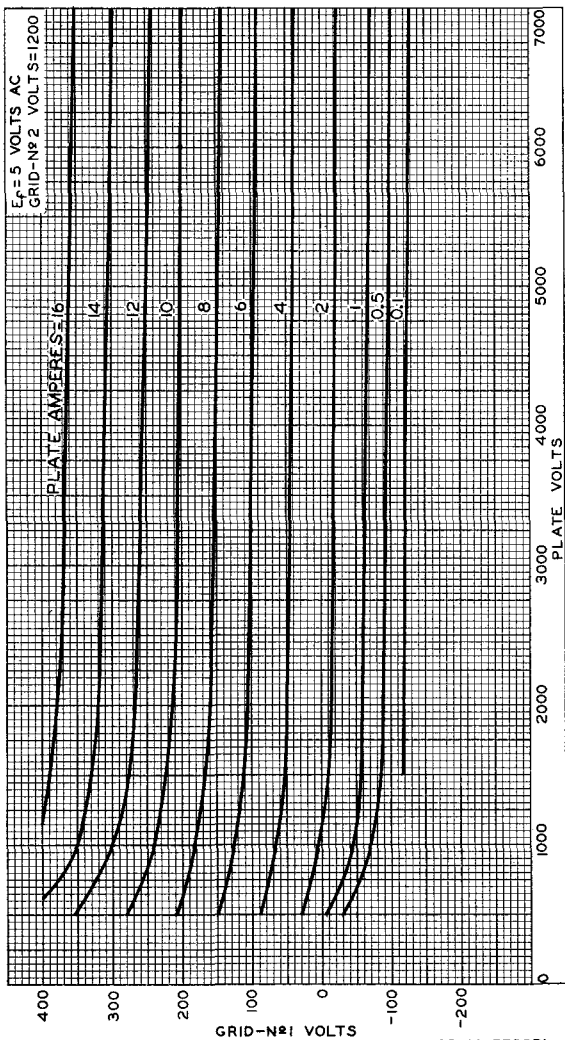

92CM-7733RI



RADIO CORPORATION OF AMERICA
 Electron Tube Division
 Harrison, N. J.

DATA 9
 5-61

AVERAGE PLATE CHARACTERISTICS

Cathode-Drive Service



92CM-7750RI



RADIO CORPORATION OF AMERICA
 Electron Tube Division
 Harrison, N. J.

DATA 10
 1-62

AVERAGE CHARACTERISTICS

Cathode-Drive Service

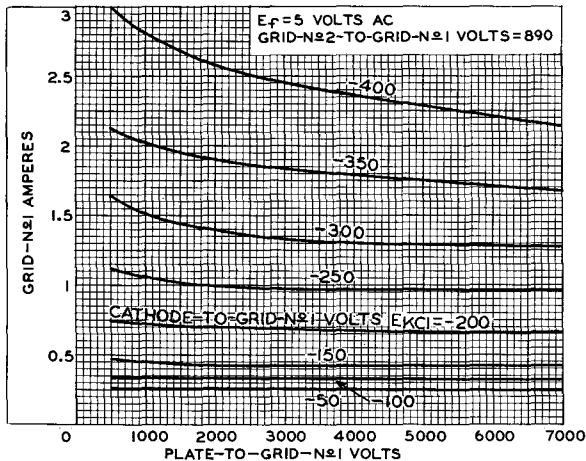

92CS-7746R1

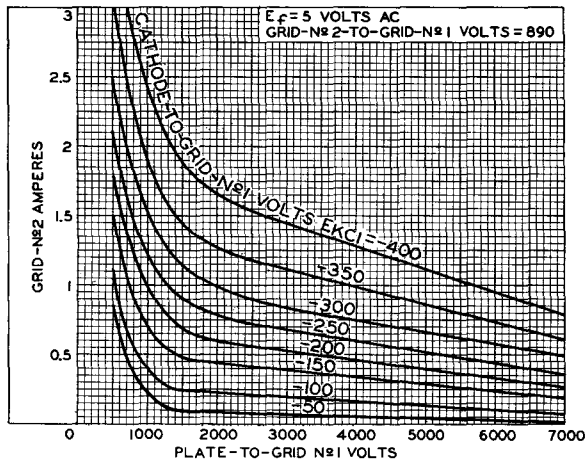

92CS-7752R3



AVERAGE CONSTANT-CURRENT CHARACTERISTICS

Cathode-Drive Service

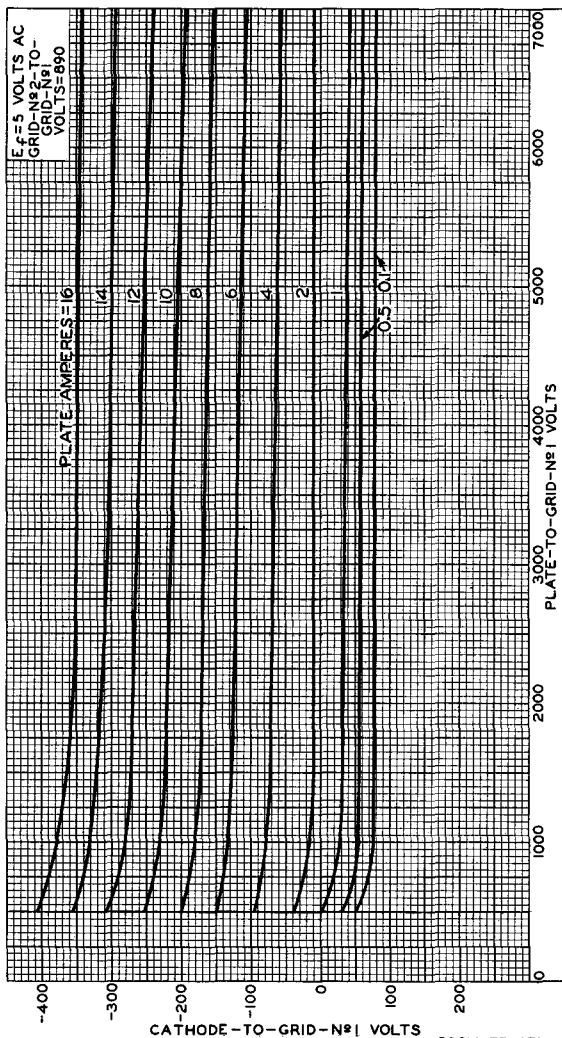

AVERAGE CONSTANT-CURRENT CHARACTERISTICS

Cathode-Drive Service

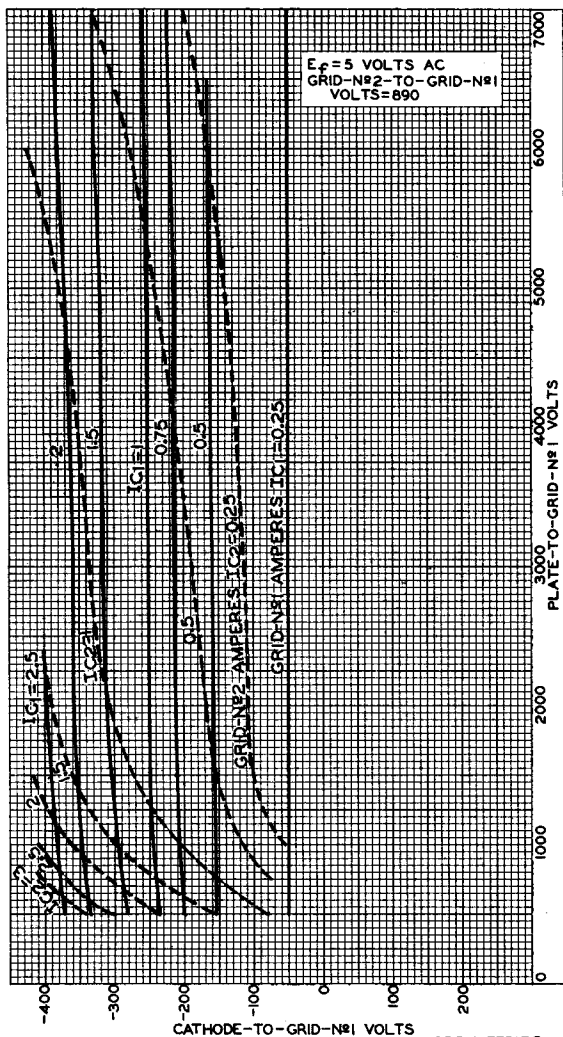

92CM-7751R2

